

Submittal

Split System Heat Pump

4A6H4024N1000A

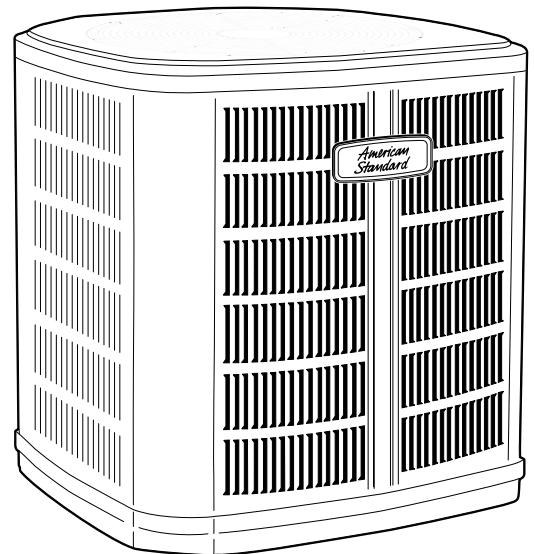

Note: "Graphics in this document are for representation only. Actual model may differ in appearance."

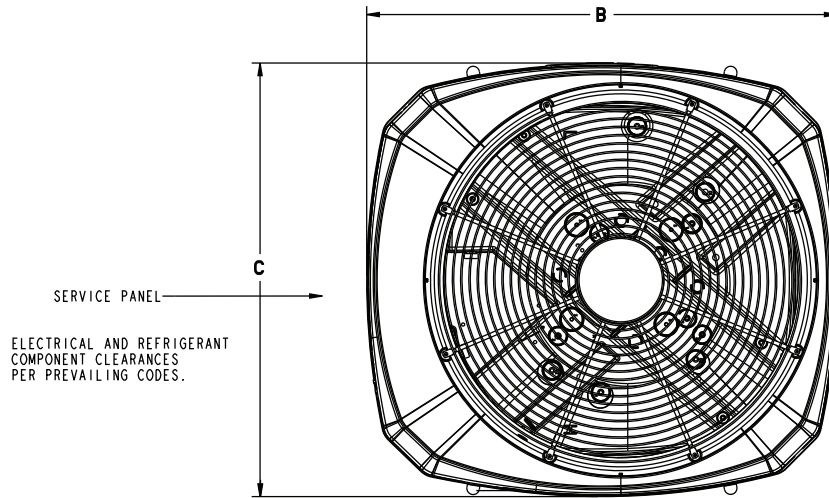

TOP DISCHARGE AREA SHOULD BE UNRESTRICTED FOR AT LEAST 1524 (5 FEET) ABOVE UNIT. UNIT SHOULD BE PLACED SO ROOF RUN-OFF WATER DOES NOT POUR DIRECTLY ON UNIT, AND SHOULD BE AT LEAST 305 (12") FROM WALL AND ALL SURROUNDING SHRUBBERY ON TWO SIDES. OTHER TWO SIDES UNRESTRICTED.

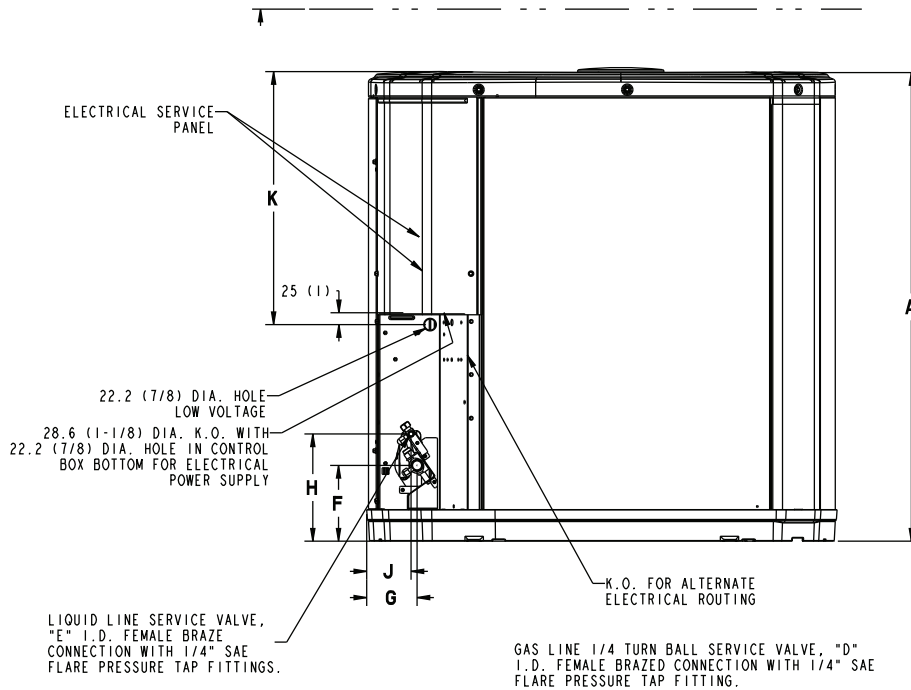

Model	Base	A	B	C	D	E	F	G	H	J	K
4A6H4024N	3	832 (32-3/4)	829 (32-5/8)	756 (29-3/4)	3/4	3/8	127 (5)	76 (3)	197 (7-3/4)	60 (2-3/8)	508 (20)

Sound Power Level									
MODEL	A-Weighted Sound Power Level [dB(A)]	Full Octave Sound Power(dB)							
		63 Hz*	125 Hz	250 Hz	500 Hz	1000 Hz	2000 Hz	4000 Hz	8000 Hz
4A6H4024N	71	77	72	68	68	69	60	53	47

Note: Rated in accordance with AHRI Standard 270-2008 *For Reference Only

Product Specifications

OUTDOOR UNIT ^{(a) (b)}	4A6H4024N1000A
POWER CONNS. – V/PH/HZ ^(c)	208/230/1/60
MIN. BRCH. CIR. AMPACITY	15
BR. CIR. PROT. RTG. – MAX. (AMPS)	25
COMPRESSOR	DURATION™ - SCROLL
NO. USED – NO. STAGES	1 – 1
VOLTS/PH/HZ	208/230/1/60
R.L. AMPS ^(d) – L.R. AMPS	11.5 – 59.5
FACTORY INSTALLED	
START COMPONENTS ^(e)	NO (Uses BAYKSKT263)
INSULATION/SOUND BLANKET	NO
COMPRESSOR HEAT	NO
OUTDOOR FAN	PROPELLER
DIA. (IN.) – NO. USED	23 – 1
TYPE DRIVE – NO. SPEEDS	DIRECT – 1
CFM @ 0.0 IN. W.G. ^(f)	2980
NO. MOTORS – HP	1 – 1/8
MOTOR SPEED R.P.M.	850
VOLTS/PH/HZ	208/230/1/60
F.L. AMPS	0.77
OUTDOOR COIL – TYPE	SPINE FIN™
ROWS – F.P.I.	1 – 24
FACE AREA (SQ. FT.)	18.75
TUBE SIZE (IN.)	3/8
REFRIGERANT CONTROL	EXPANSION VALVE
REFRIGERANT	
LBS. – R-410A (O.D. UNIT) ^(g)	6 LBS., 2 OZ
FACTORY SUPPLIED	YES
LINE SIZE – IN. O.D. GAS ^{(h) (i)}	3/4
LINE SIZE – IN. O.D. LIQ.	3/8
CHARGING SPECIFICATIONS	
SUBCOOLING	10°F
DIMENSIONS	H X W X D
CRATED (IN.)	38 x 30.1 x 33
WEIGHT	
SHIPPING (LBS.)	208
NET (LBS.)	174

- (a) Certified in accordance with the Air-Source Unitary Air-conditioner Equipment certification program, which is based on AHRI standard 210/240.
- (b) Rated in accordance with AHRI standard 270.
- (c) Calculated in accordance with Natl. Elec. Codes. Use only HACR circuit breakers or fuses.
- (d) This value shown for compressor RLA on the unit nameplate and on this specification sheet is used to compute minimum branch circuit ampacity and max. fuse size. The value shown is the branch circuit selection current.
- (e) No means no start components. Yes means quick start kit components. PTC means positive temperature coefficient starter. Optional kit shown.
- (f) Standard Air – Dry Coil – Outdoor
- (g) This value approximate. For more precise value see unit nameplate.
- (h) Reference the outdoor unit ship-with literature for refrigerant piping length and lift guidelines. Reference the refrigerant piping software pub # 32-3312-xx or refrigerant piping application guide SS-APG006-xx for long line sets or specialty applications (xx denotes latest revision).
- (i) The outdoor condensing units are factory charged with the system charge required for the outdoor condensing unit, ten (10) feet of tested connecting line, and the smallest rated indoor evaporative coil match. Always verify proper system charge via subcooling (TXV/EEV) or superheat (fixed orifice) per the unit nameplate.

Mechanical Specification Options

General

The outdoor condensing units are factory charged with the system charge required for the outdoor condensing unit, ten (10) feet of tested connecting line, and the smallest rated indoor evaporative coil match. This unit is designed to operate at outdoor ambient temperatures as high as 115°F. Cooling capacities are matched with a wide selection of air handlers and furnace coils that are AHRI certified. The unit is certified to UL 1995. Exterior is designed for outdoor application.

Casing

Unit casing is constructed of heavy gauge, galvanized steel and painted with a weather-resistant powder paint finish. The corner panels are prepainted. All panels are subjected to our 1,000 hour salt spray test.

Refrigerant Controls

Refrigeration system controls include condenser fan, compressor contactor and low and high pressure switches. A factory supplied, field installed liquid line drier is standard.

Compressor

The compressor features internal over temperature and pressure protection. Other features include: Centrifugal oil pump and low vibration and noise.

Condenser Coil

The outdoor coil provides low airflow resistance and efficient heat transfer. The coil is protected on all four sides by louvered panels.

Low Ambient Cooling

As manufactured, this system has a cooling capacity to 55°F. The addition of an evaporator defrost control permits operation to 40°F. The addition of an evaporator defrost control with TXV permits low ambient cooling to 30°F.

The addition of the BAYLOAM107A low ambient kit permits ambient cooling to 20°F.

Thermostats – Cooling only and heat/cooling (manual and automatic change over). Sub-base to match thermostat and locking thermostat cover.

American Standard[®]
HEATING & AIR CONDITIONING

About American Standard Heating and Air Conditioning
American Standard has been creating comfortable and affordable living environments for more than a century. For more information, please visit www.americanstandardair.com.



The AHRI Certified mark indicates company participation in the AHRI Certification program. For verification of individual certified products, go to ahridirectory.org.

The manufacturer has a policy of continuous data improvement and it reserves the right to change design and specifications without notice. We are committed to using environmentally conscious print practices.

4A6H4024N-SUB-1A-EN 12 Aug 2022
Supersedes (New)

©2022 American Standard Heating and Air Conditioning