



Versatile. Simple. Attractive.

ACO Self® drainage – around the house

ACO Euroline

ACO Hexaline

ACO Highline



Versatile. Simple. Attractive

Rainwater that is not drained properly damages the building's structure, inside as well as outside. Therefore, someone who builds a property or rebuilds it automatically asks the following question. "Which systems are needed around the house in order to keep the forecourt and its own four walls cleanly and attractively free of dampness?" "How can the functionality be combined with aesthetics while doing so?" Faultlessly functioning systems for drainage of private and public spaces are continuously gaining more significance precisely during the course of the changing climate, since the changing climate in Central Europe is not only leading to increasing temperatures but also to more extreme rainfall, which often occurs after long periods of drought.

Consequently, it is important to build around the house far-sightedly – whether it be on driveways, paths, terraces or facades – so that no damage can be caused to the building's structure by these intense changes in the weather.

ACO offers you the drainage channels in the ACO Self® range to cope with all conceivable situations on the plot of land and to suit the most varied requirements: they guarantee that the water from rainfall will be properly drained and they do substantially more than simply fulfil a function at the same time because you can choose from a huge variety of constructions that combine functionality and design at the highest level of quality. The drainage channel is integrated optimally into the design of the plot according to your aesthetic ideas.



ACO Self® drainage systems keep driveways, paths, terraces and facades free of rainwater and dirty water; thereby protecting the building's structure.





Ensure that there is proper drainage around the house.



The new Microgrip grating not only has a very attractive and unique appearance but it also makes a great contribution to safety in your own home on account of its surface's anti-slip structure.



Slotted grating
Galvanized steel



Slotted grating
Polished stainless steel



Powder-coated
slotted grating
Anthracite colour



Powder-coated
slotted grating
Terracotta colour



Mesh grating
Stainless steel

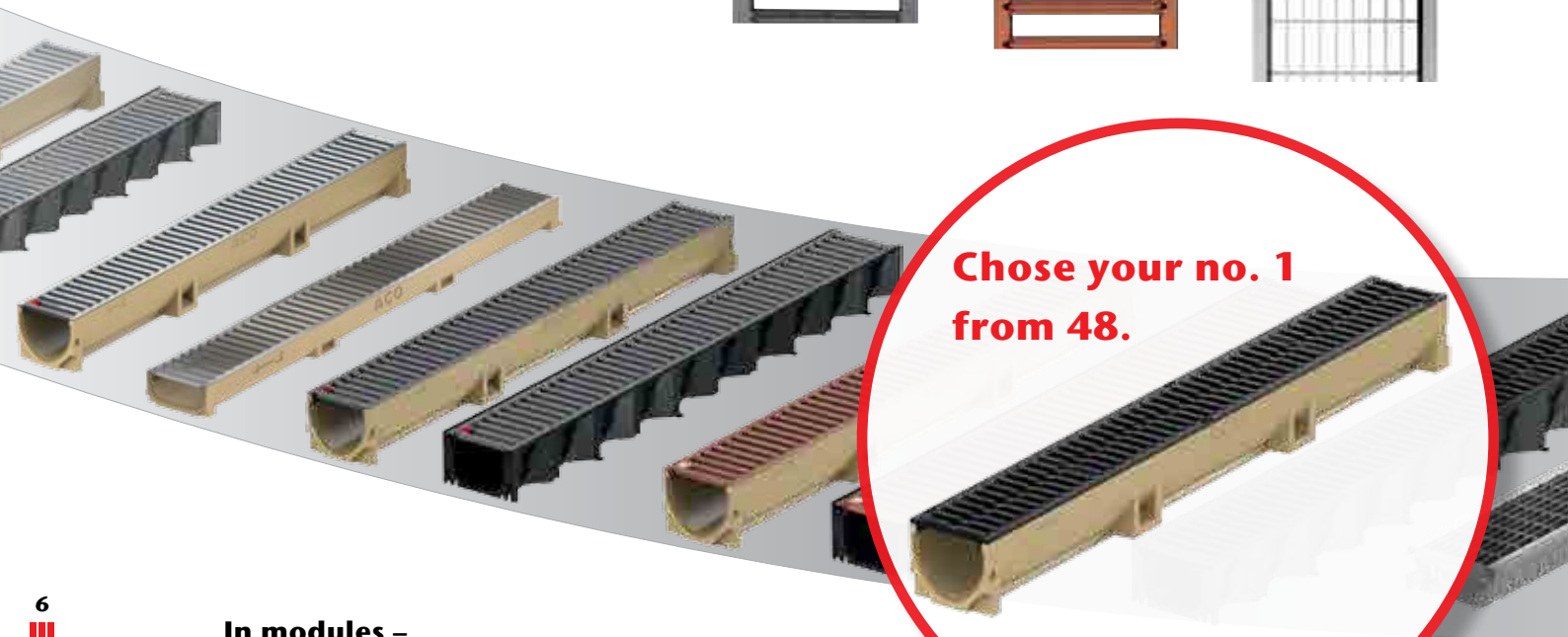

**In modules –
a channel for every application**

The ACO Self® drainage system has been specially developed for the private area of application and it combines the best quality with high-grade design. The grating covers resist car traffic and they are suitable for all requirements as a result, in order to drain areas around the house. Various materials are available to choose for the covers, which range from galvanized powder-coated steel, stainless steel and cast iron to plastic. There are many possibilities for design as a result. The channel bodies are made from plastic and polymer concrete or they are made from stainless steel or galvanized steel as facade channels. Therefore, individual solutions are available for every building situation,

which you can combine by using the modular principle. The ACO Self® flat channel is used where installation heights are low. The ACO Self® Highline enables the frontage to be drained with an open channel system undertaking draining on two levels. Basically referred to here are balconies and patios.



Euroline channel body made from polymer concrete: trust ACO's many years of key competence; it resists car traffic.

Mesh grating
Galvanized steel



Cast iron grating*



* The cast iron grating is not recommended as a cover for the Highline model (contact corrosion)

Anti-slip
Microgrip grating



Brickslot frame
Stainless steel, galvanized steel and plastic

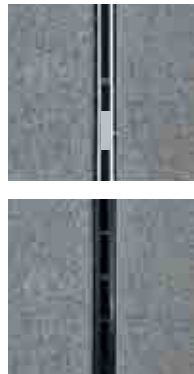

Slatted grating
Stainless steel



12 grating designs are available to choose from.



Combine one of the three channel bodies with them.



NEW Euroline 60 channel body – polymer concrete flat channel, for light vehicle traffic

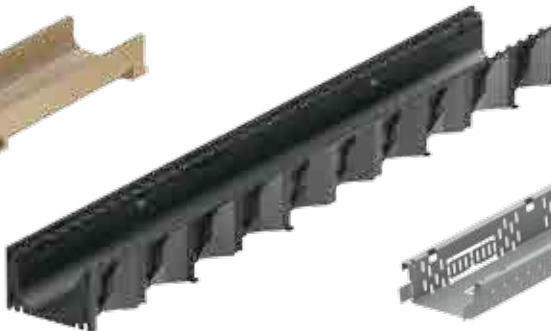

Hexaline channel body – ACO quality made from plastic, resistant to car traffic

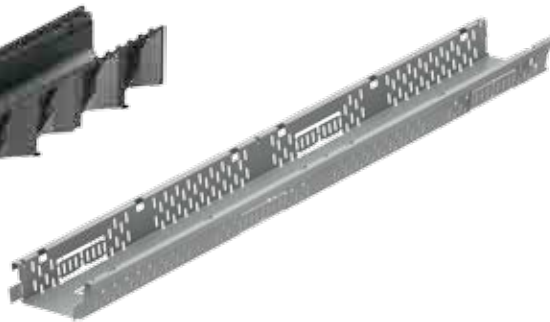

Highline channel body – ACO façade channel, stainless steel or galvanized steel, walkable

The surface with **Microgrip** ensures high anti-slip resistance even when wet.

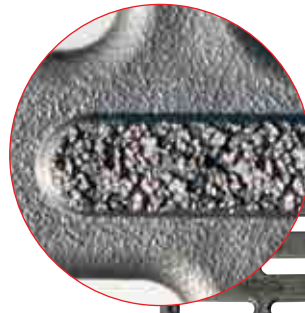

Resistant to car traffic

Resistant to UV light

Uniform, black, cast-iron appearance without the patina that is caused by corrosion that is typical for cast iron

It can be easily shortened to any length.

The unique anti-slip structure of the plastic grating has been filed for a patent.



The cleaning and maintenance of the channels under all of the gratings can be done really easily thanks to the screwless locking system on the gratings.

1

Gratings with fully functional details

The new generation of Self® drainage systems excels not only because of its comprehensively great variety of design but also because it has some innovative highlights.

1 Anti-slip Microgrip grating

Smooth surfaces can quickly become slippery in the area of terraces or the house's entrances. Many floor coverings have anti-slip surfaces for this reason. ACO's new plastic grating with Microgrip also offers an anti-slip cover for drainage

channels around the house for the first time. The grating is equipped with many small projections in addition to the pimpled texture, which ensure that the shoes grip firmly even if they are very wet. The texture is directly formed in the grating's

surface and it is particularly durable as a result. The plastic grating retains its anti-slip property even when it is heavily loaded by a car travelling over it.



The new plastic grating.



Microgrip achieves a Class R11 anti-slipping characteristic according to DIN 51130.

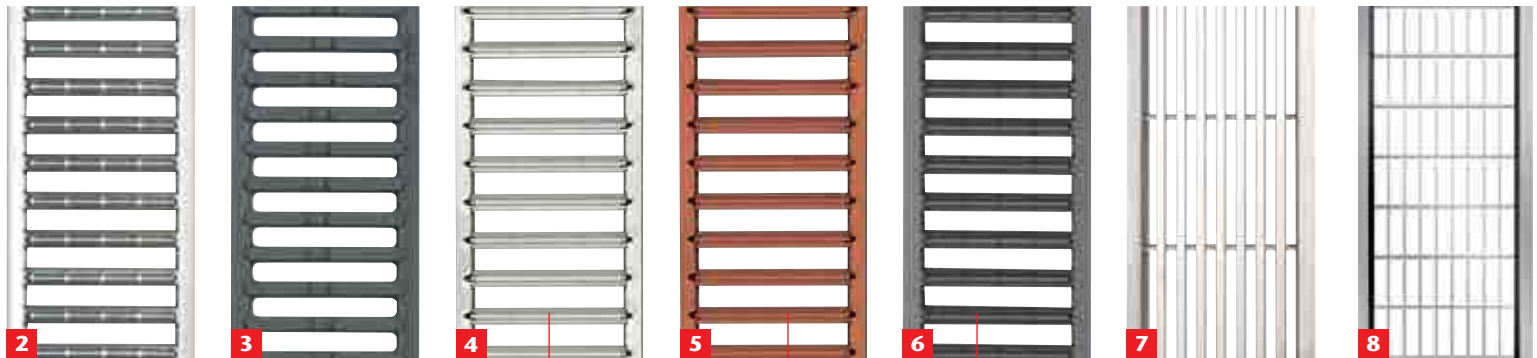

A specially high degree of gloss is achieved by means of electro-polishing the surface

Powder-coating offers additional resistance to corrosion and the modern paint that resists UV light enables modern design

2/3 – Slotted grating and cast-iron grating

The slotted grating made from galvanized steel and the cast-iron grating are the classics in the Self® grating range. The robust material and the striking corrugated design continue to be qualitative features of the cast-iron grating

4 – Polished stainless steel grating

The proven stainless steel slotted grating radiates a really new gloss. The high-grade electro-polishing is not only a visual highlight but mud sticks to it less easily on account of its special surface property.

5/6 – Powder-coated slotted grating

The powder-coated grating made from galvanized steel is also available in a second colour besides anthracite black. The new terracotta grating is particularly attractive in prestigiously paved surfaces. The powder coating offers additional protection against corrosion besides the galvanizing and the appearance lasts for many years because of the paint that is resistant to UV light.

7 – Wedge wire grating

The narrow triangular profiles and a brushed surface give the wedge wire grating a particularly elegant appearance. Furthermore, it is made from high-grade stainless steel and it is extremely durable as a result.

8 – Mesh grating

Mesh gratings have a particularly large inlet cross section on account of their highly rigid yet slim load-bearing structure. Even large amounts of water will be quickly collected and reliably drained via the channel. Excessive water is prevented even in inclined positions as a result. The mesh size of 30 mm x 10 mm simultaneously offers a stylish effect. The ACO Self® mesh gratings are available in the versions of galvanized steel and stainless steel. As a result, they satisfy the requirements of the most diverse installed positions



The Self® range offers various gratings for a huge variety of possible designs

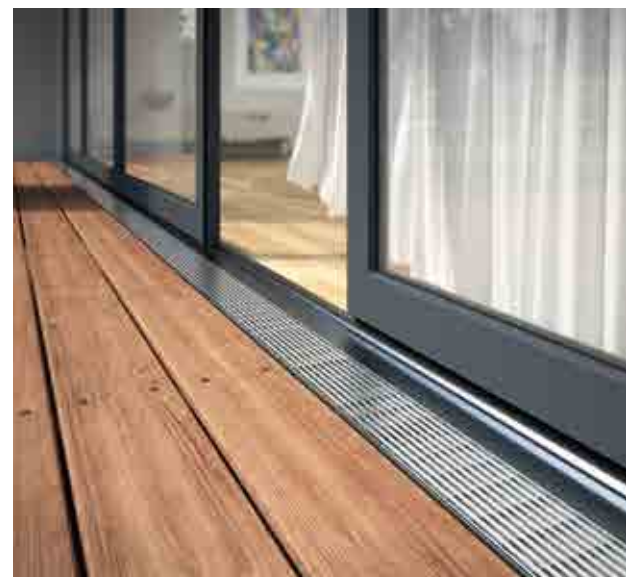

Façade and entrance: elegantly designed accessibility with identical gratings



Drainage is elegantly integrated into the overall appearance by using the narrow slotted grating.



9 – Brickslot frame in stainless steel and galvanized steel

The new slotted frame caps allow particularly discrete drainage of your external areas. They integrate elegantly into stylishly designed paved surfaces and they conserve the design's appearance as a result.

The brickslot frames are available in not only galvanized steel but also stainless steel.

The new connector clip ensures a harmonious appearance. The slotted frames are optimally aligned during the installation in one easy step. You always obtain a continuously flowing line in this way, which functions optimally.

You can find some advice about the hydraulic performance of the slotted frame drainage system on pages 20 and 21.

10 – Brickslot frame made from plastic

The anti-corrosive plastic cap that is resistant to UV light ensures a durably designed solution, which integrates into the general effect discretely as a brickslot frame. It can be used at the end of the driveway, on the terrace or along the garage. An inspection unit enables simple cleaning.

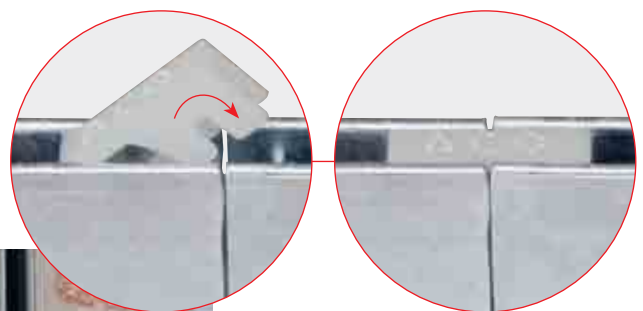

Slotted frames that abut each other without the connector clip



Brickslot frames with the connector clip

Two brickslot frames that abut each other can be connected with the connector clip and thereby maintain the line exactly.

System setup and maintenance of the ACO Self® slotted channel

The ACO Self® channels with a brickslot frame are maintained via an inspection unit that is placed directly over the outlet. A half-metre long component or a 15 cm long component is available for this purpose, according to the system's construction. The inspection unit should be opened about twice a year to flush out the channel run. It is recommended to carry out the flushing more frequently according to the local conditions, or to provide a second inspection unit at the other end of the channel run, in order to make the cleaning easier.

ACO Self® slotted channel with an inspection unit and sump unit

The half-metre long inspection unit is integrated optimally into the overall appearance, since the surrounding paving can also be fitted around the tray. The drainage slot is continued laterally, in order to ensure that the water is also collected via the inspection unit. The component can be easily opened with two lifting hooks subsequently. Cleaning of the system is extremely easy with the help of the dirt trap if it is placed directly on top of the sump unit.



ACO Self® slotted channel with an inspection unit

The small inspection unit is suitable in combination with a brickslot frame that is 850 mm in length for using on the Hexaline channel body with discharge nozzles. The tray can be utilized upwards as a closed cover. The surrounding paved surface can be alternatively fitted into the tray – even in the case of a smaller inspection unit – for a particularly discrete solution.



A complete system with many possibilities

ACO Self® Euroline – the channel body made from polymer concrete

Advantages

- 3 channel components made from polymer concrete (0.5 m and 1 m long channel components that are closed and have connectors according to DN 100) enable various configurations of the system
- Frostproof
- Low weight with high strength
- Smooth surface for high flowing speed and convenient cleaning
- V cross-section
- The open cross-section makes the cleaning easier
- Screwless locking of the grating
- Resistant to car traffic

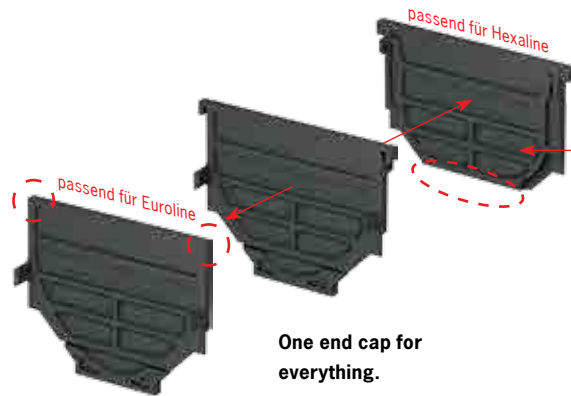

Tip:

The preformed areas can be pushed out optionally in the case that the drained volume is small. An outflow via the combined end cap is possible as a result.

Connection to the buried drain via the end cap with connectors according to DN 100

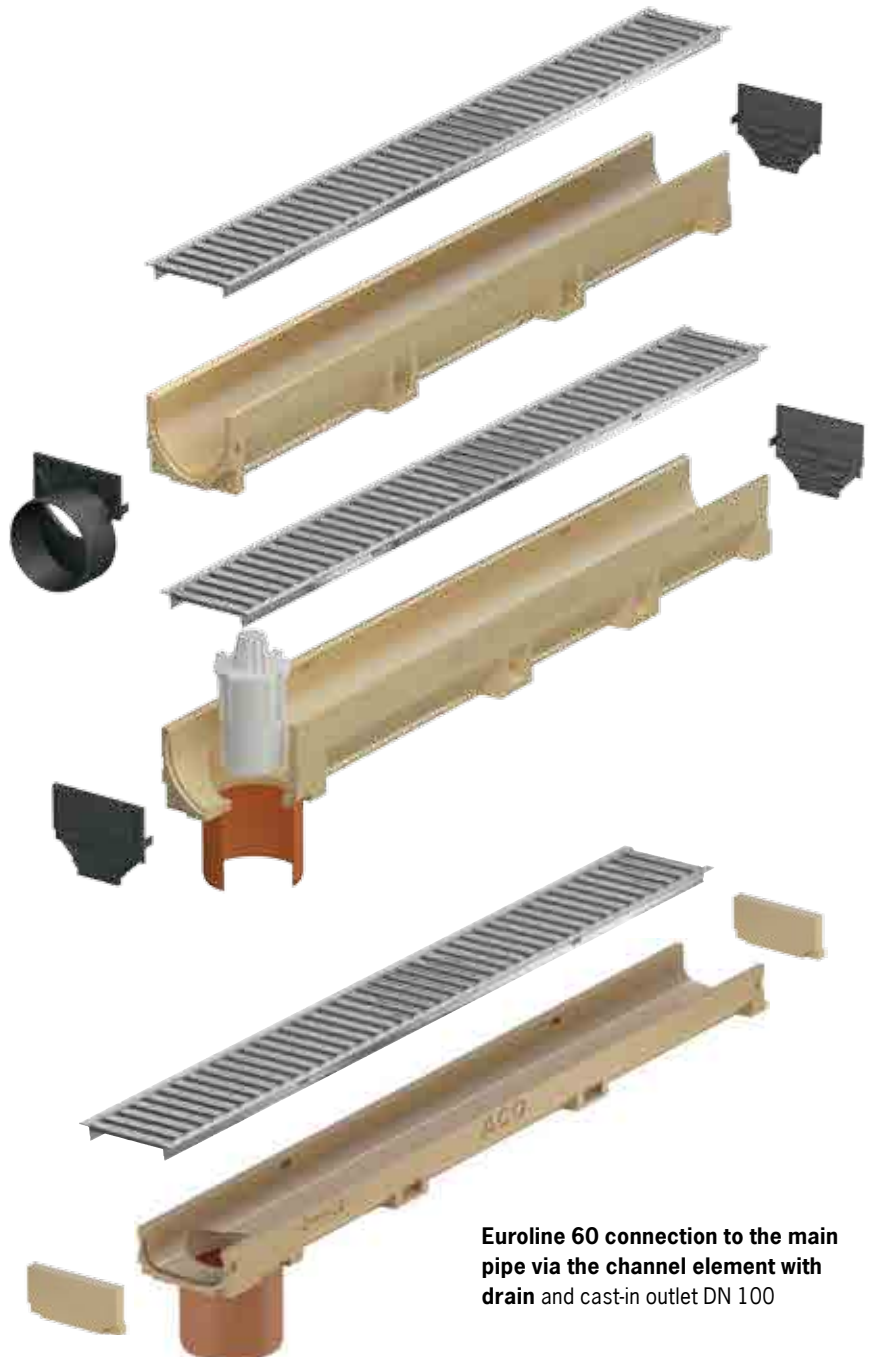

Connection to the buried drain via the channel component with the outflow opening and moulded connectors according to DN 100; optionally with an foul air trap.

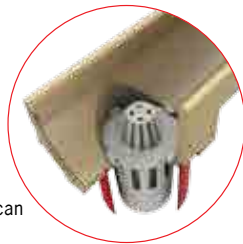

The foul air trap can be inserted subsequently.

End cap for Euroline 60

Euroline 60 connection to the main pipe via the channel element with drain and cast-in outlet DN 100

Connection to the buried drain via the sump unit (does not match the Euroline 60 flat channel)

Dirt trap for convenient cleaning

V cross-section

Tip:

The connection of the channel run via the sump unit is particularly convenient. The integrated dirt trap offers two advantages at the same time: the entry of dirt into the buried drain is reliably prevented and the cleaning is noticeably simplified.

Optional: an foul air trap for sump units

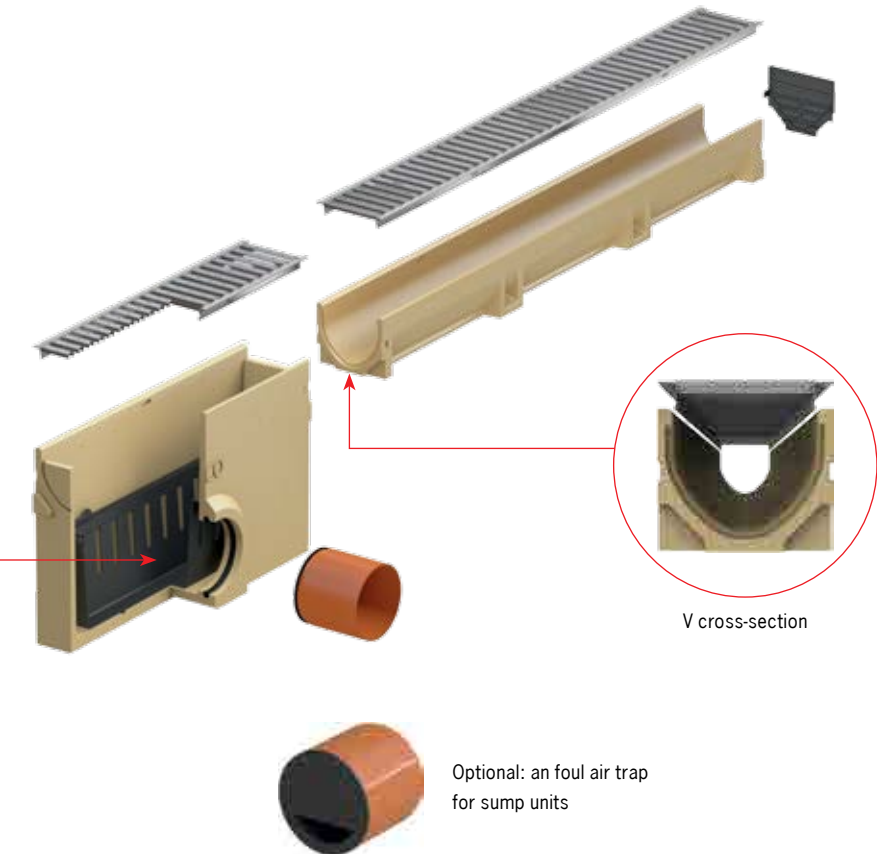

The sump unit is the most efficient of the outflow connections if the amount of water is 6 litres per second and therefore it offers more security against being overloaded. (You can find details about the hydraulic performance of the channel systems on pages 20 and 21.) It is indispensable to clean the drainage system regularly. Heavy soiling can reduce the outflow's efficiency by more than 50%. An foul air trap can be inserted into the sump unit, in order to prevent unpleasant odours escaping from the buried drain.



See page 22 for the installing instructions

**ACO Self® Hexaline –
the channel body made from plastic**

Advantages

- 1 channel component made from plastic for flexible applications
- Frostproof
- Particularly low weight, easy assembly and handling
- Smooth surface for high flowing speed and convenient cleaning
- Highly rigid side walls because of the hexagonal structure
- Screwless locking of the grating
- Resistant to car traffic



Highly rigid side walls

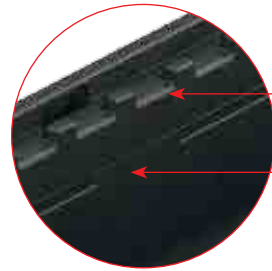

Double support for the grating with an integrated expanding-and-pushing anchor for improved removal of load

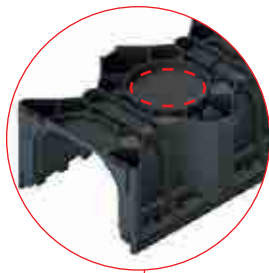

8 connecting points for the vertical outflow connection are possible per metre (deflectable).

Outlet end cap for filtration



Cutting guide for sawing of 0.5 m channel components

Shortening of the channel at any point is alternatively possible

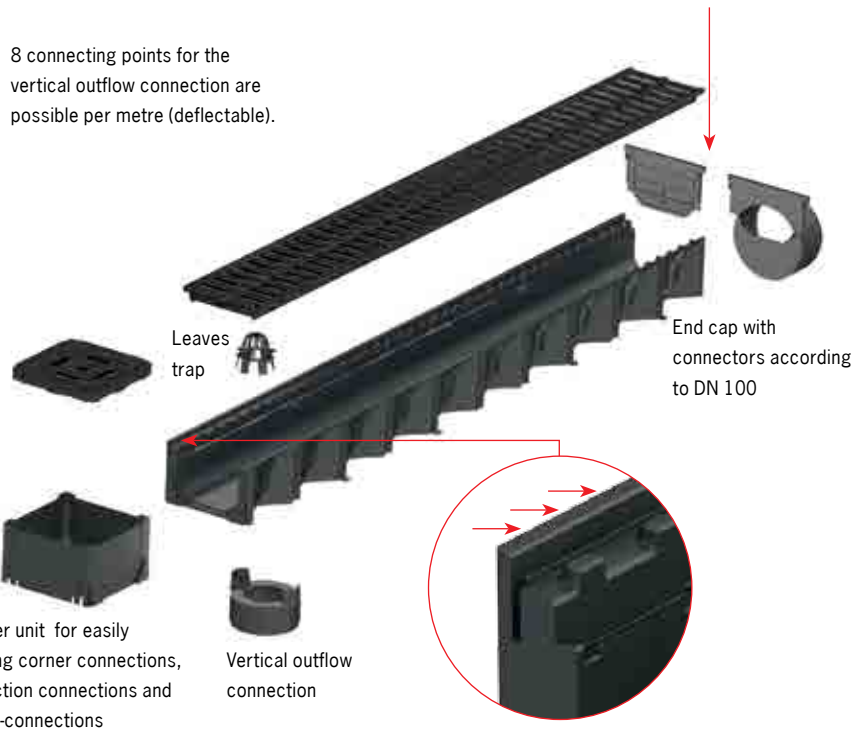

End cap with connectors according to DN 100

Leaves trap

Corner unit for easily making corner connections, T junction connections and cross-connections

Vertical outflow connection

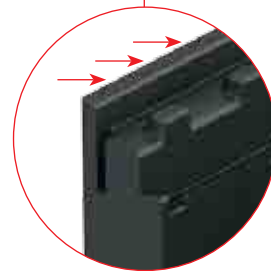

Compatible edge for easy junction with paved surfaces

Installation instruction on the underside of the ACO Hexaline

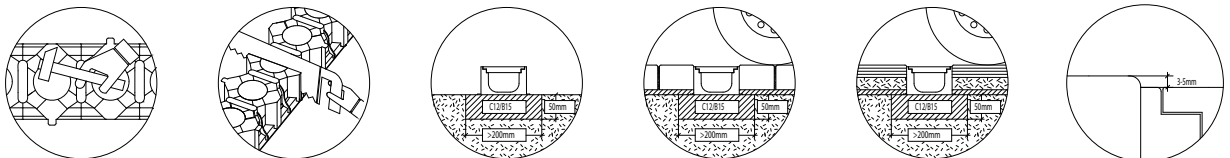

Connection of the end cap to the ACO Self® Euroline

Connect Clip A to the polymer concrete body.
Remove Clip B twice and Area X twice.

Page 1 Pointing to the channel



Page 2



1. Remove Area X and Clip B on the left and right with the cutter



2. Let the Clips A engage

Connection of the end caps to the ACO Self® Hexaline

Connect Clip B to the plastic channel body.
Remove Clip A twice and Area Y.

Page 1 Pointing to the channel



Page 2



1. Break off Area Y at the reference breaking point



2. Remove Clip A on the left and right with the cutter



3. Allow Clips A to engage

It applies to the entrance areas and the plinth of the house:

the water must be drained properly

It applies to transitional areas between the open spaces and the building – like one finds on balconies and terraces as well as on areas of the entrance, plinth and façade – that “the water must be drained reliably”. The transition between the open space and the building is a sensitive area because standing water here can lead to building damage in the medium term. The entrance areas where low threshold constructions are frequently used are particularly jeopardized.

The waterproofing height on the adjoining façade is clearly regulated in the following standards and sets of rules.

- DIN 18195, Part 9
- The FLL’s recommendation for planning, building and maintaining the transitional areas between open spaces and buildings
- Guideline on flat roofs

This case described the waterproofing against moist soil and sometimes standing percolated water must be dressed above the surface of the terrain by

30 cm, so that the distance between the finished paving and the top of the waterproofing is at least 15 cm in the finished state. Advice: waterproofing of the structure is integrated into the wall’s construction and it could be invisible from the outside. If the connecting height of the waterproofing is less than 15 cm, then an efficient drainage system must be provided at the transition between the open space and the building. Furthermore, a noticeable reduction of the impingement from sprayed water is required.



Two reliable solutions for draining the facade

The rainwater will be drained reliably in the case of closed channel systems like the ACO Self® Euroline or the ACO Self® Hexaline and a connection to a drainage system or a soakaway system like the ACO Self® Infiltration Line. Advice: an ACO Self® shoe scraper with a connection to the drainage system is also a good technical solution with double benefits in the entrance area.

The **ACO Self® Highline** façade channel represents a further drainage solution.

The matter concerns an **open channel system** that allows filtration, rather like a strip of gravel around the house. Care must be taken in this case that the impingement of moisture on the basement wall could be increased in certain circumstances as a result. Furthermore, this channel system can be utilized on roof gardens, roof terraces and balconies according to the guidelines on flat roofs.

NEW: all channel systems use the same covering grating.

ACO Self® Highline – the system

- Version in stainless steel and galvanized steel
- **Building lengths up to 3 m**
- The channel body can be stapled: space-saving storage, easy handling on the building site
- The channel connector is integrated in the channel body (also available separately).
- The channel connector is usable as a brace, channel connector and fixture of the end cap.
- Walkable
- Building width: 12 cm.
- Building height: 5 cm and 7.5 cm.
- Building length: 50 cm, 100 cm, 200 cm and 300 cm
- Accessories: end cap, channel connector or stiffener



Low need for space because stackable



End cap and channel connector or brace



Good handling on the building site and in the store

Caution!

The channel system is **not** resistant to car traffic. Three locking bolts must be used per metre when the Highline is used in a walkable area. If the channel is not exposed to any loading from above, then no brace for stiffening is required.



The channel connector or brace is available as an accessory and it is integrated into the bottom of every channel component



The integrated channel connector is easy to remove by means of a side cutter

Typical applications



Closed channel with a connection to the drainage system: terrace with the ACO Self® Euroline



Open channel without a connection: terrace with the ACO Self® Highline



Closed channel with a connection to the soakaway system: façade with the ACO Self® Hexaline



Open channel with drainage above the roof waterproofing membrane: balcony with the ACO Self® Highline

Review of the complete system

Illustration	Description	Length [mm]	Width [mm]	Height [mm]	Article no
ACO Self® Euroline made from polymer concrete					
	Channel component without grating	1000	118	97	38500
	Channel component without grating	500	118	97	38502
	Channel component with outlet connector, without grating	1000	118	97	38501
	Sump unit without grating, including dirt trap (does not fit onto Euroline 60)	500	118	300	38503
	Flat channel element, no grate	1000	118	55	810000
	Flat channel element, no grate	500	118	55	320276
	Flat channel element with run-off nozzle, no grate	1000	118	55	810010
ACO Self® Hexaline made from plastic					
	Gutter component without grating	1.000	129	79	319200
ACO Self® Highline					
	Façade channel component without grating, galvanized steel	1.000	120	50	320095
		500	120	50	320096
	Façade component without grating, stainless steel	1.000	120	50	320103
		500	120	50	320104
ACO Self® gratings					
	Slotted grating galvanized steel	1.000	118	-	38516
		500	118	-	38517
	Powder-coated slotted grating, anthracite colour	1.000	118	-	10305
		500	118	-	10306
	Powder-coated slotted grating, terracotta colour	1.000	118	-	310305
		500	118	-	310306
	Slotted grating Electro-polished stainless steel	1.000	118	-	310307
		500	118	-	310308
	Cast-iron grating (not recommended for the ACO Self® Highline)	500	118	-	310309
	Anti-slip Microgrip grating plastic	1.000	118	-	319250
		500	118	-	319251
	Slatted grating stainless steel	1.000	118	-	10323
		500	118	-	10324
	Mesh grating galvanized steel	1.000	118	-	310310
		500	118	-	310311
	Mesh grating stainless steel	1.000	118	-	310312
		500	118	-	310313



Illustration	Description	Length [mm]	Width [mm]	Height [mm]	Slot height [mm]	Article no
ACO Self® Brickslot frame						
	Brickslot frame galvanized steel	1.000	118	–	105	415838
		850	118	–	105	415840
		500	118	–	105	415850
	Inspection unit galvanized steel	500	118	105	–	415839
		150	118	105	–	415841
	Brickslot frame stainless steel	1.000	118	–	105	415842
		850	118	–	105	415844
		500	118	–	105	415851
Inspection unit stainless steel	500	118	105	–	415843	
	150	118	105	–	415845	
ACO Self® Brickslot frame made from plastic						
	Brickslot frame plastic	500	125	–	60	319554
	Inspection unit plastic	125	125	146	–	319560

Illustration	Description	Art. no.
Accessories for the ACO Self® Euroline		
	Foul air trap channel two parts	01666
	Odour connector Sump unit DN 100	01684
	Dirt trap for the sump unit	01682
Accessories for the ACO Self® Hexaline		
	Vertical outflow connector	19286
	Leaf guard	319282
	Universal seepage piece for 90°, 180° and 270° connections	19280

Illustration	Description	Art. no.
Common accessories for the ACO Self® Hexaline and Euroline		
	End cap, closed for starting and ending the channel	319288
	End cap with connector for the channel's end	319289
	Grating hooks	03429
	Lifting tool for the slotted frame's inspection unit 0.5 m	415924
	ACO Water seal 300 ml for sealing the channel bodies	74520
Accessories for the ACO Self® Highline		
	End cap, galvanized steel, 50 mm	320097
	End cap, stainless steel, 50 mm	320105
	Channel connector galvanized steel	320123
	Channel connector Stainless steel	320122
Accessories ACO Self® Euroline 60 flat channel		
	Polymer concrete end cap	810200

Calculation of hydraulic efficiency for the ACO Self® Euroline¹⁾ and Hexaline

Example 1 Step for step

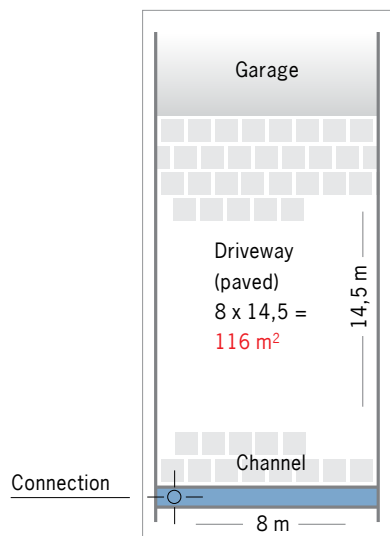

1st step: basic data

The driveway in the shown building project shall be drained. The paved surface must be **116 sq.m**. The planning intends a 8 m channel run at the boundary with the path. The connection to the buried drain shall be made at the end of the channel run. A slope in the terrain in the direction of the channel does not exist. It must now be checked whether the planned construction of the channel run reliably drains the water that falls on the surface.

2nd step: rainfall

Further information must be obtained first of all for the calculation. The rainfall (r) measured in l/(s x ha), gives which quantity of water must be expected at the site of the respective building project.

It can be queried from the responsible building control office. If no definitive rainfall is given, then an average value of 250 l/(s x ha) can be set. This example accordingly assumes that **r = 250 l/(s x ha)**.

3rd step: hydraulic table

The rainfall of **250 l/(s x ha)** must be chosen first of all in the first column of hydraulic table. The figure in square metres of the drained surface must be chosen in the associated line. This example shows the surface of **116 m²**; therefore, **115 m²** is chosen as the next available value. If one follows the column downwards from this value, then the maximum possible length of continuous channel arises for the respective Euroline or Hexaline type of channel.

Hydraulic table

Rainfall [r]	Calculated surface to be drained [sq.m.]															
200 l/(s*ha)	≥160	149	144	137	134	130	124	118	105	101	96	93	91	86	81	71
225 l/(s*ha)	≥140	133	128	122	119	116	110	105	93	90	85	83	81	76	72	63
250 l/(s*ha)	≥125	119	115	110	107	104	99	94	84	81	77	74	73	69	65	57
275 l/(s*ha)	≥115	109	105	100	97	95	90	86	76	74	70	68	66	62	59	52
300 l/(s*ha)	≥105	100	96	91	89	87	82	79	70	68	64	62	60	57	54	48
Amount of water Q (l/s)	≥2,2	2,09	2,02	1,92	1,87	1,82	1,73	1,65	1,47	1,42	1,34	1,30	1,27	1,20	1,13	1,00

ACO channel type	max. possible continuous length [m]															
Euroline	-	2	3	6	8	10	15	20	35	40	50	55	60	70	85	120
Hexaline 2.0	-	-	-	-	-	-	-	-	2	3	6	8	10	15	20	35

The table is based upon the following basic prerequisites:

- Degree of utilizing the channel run: 85 % approx.
- Free outflow
- Terrain slope in direction of continuous channel: 0 %
- Coefficient of outflow (ψ)* = 0,7
- evenly distributed inflow of the surface water over the entire channel run.

* The outflow value (ψ) describes the percolating efficiency of the surface covering, e.g., 0.7 to 0.9 for paving; 1.0 for concrete surfaces.

One obtains the following result from the presented case

The cell for the Hexaline channel is unoccupied: this indicates that the channel is overloaded in the presented case. The cell for Euroline gives a maximum possible channel run of **3 m**. Consequently, the drainage of the garage's Driveway can be solely done with the Euroline system.

Amount of outflow to different connections	
ACO Self® Euroline	
Inflow box	6,0 l/s
Channel comp. & connector	4,5 l/s
End cap with connector	2,5 l/s
ACO Self® Hexaline 2.0	
Vertical outflow connector	2,2 l/s
End cap with connector	2,5 l/s

Advice about drainage with slotted frames

- 1.0 l/sec must be set as the amount of outflow, irrespective of the channel body and surface installation
- The installation in surfaces with a slope in one direction to the channel run is possible up to an inclination of 5%.

However, only 3 m of channel can be laid instead of the planned 8 m, in order not to overload the channel run. However, a practical approach should be chosen, as described in Step 4, because this solution does not satisfy a high-grade drainage system visually nor for reasons of workmanship.

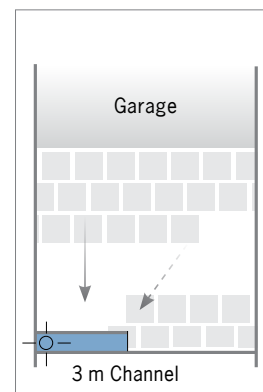

¹⁾ not for the Euroline 60 flat channel

Background:

The justification of the maximum length of channel run is based on where the connection is placed. An outflow is planned at the end of the channel run in the example. The water that falls on the surface must firstly travel through the channel before it can actually flow out. The following description diagrammatically shows the construction of the 8 m channel run that is planned in the example,

About 025 l of water will be evenly caught in every meter of channel during the rainfall. The water simultaneously runs from the end of the channel evenly towards the outflow connection. A channel component that is closer to the outflow must accordingly collect the water from all of the channel components upstream besides the inflow from the surface. Therefore, this can lead in the pre-

sented case to one channel run being overloaded on account of its length and to the associated path to the outflow being overloaded as well.

On the other hand, the description of the 3 m channel run shows that the path along which the water must travel in the channel is still short enough in this case, in order not to overload the system.

Falling (accumulating) amount of water Q in l/s

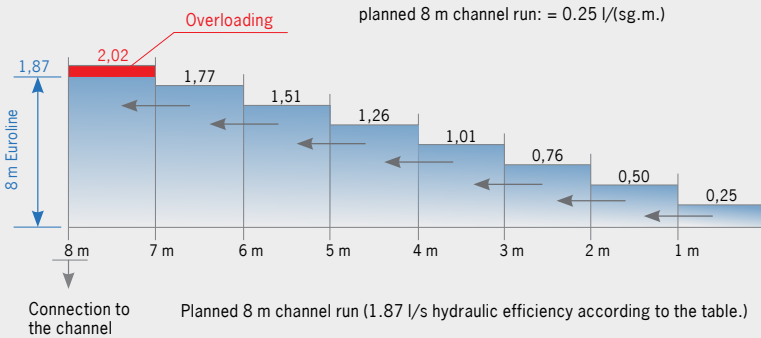

Placed surface of 8 m x 14.5 m = 116 sq.m. The chosen value in the table of 115 m² Δ 2.02 l/s is distributed over the planned 8 m channel run: = 0.25 l/(sq.m.)

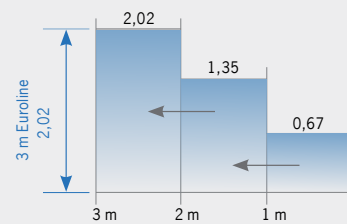

3 m continuous Euroline channel conducts 2.02 l/s (see table)

4. step Practical approach

One obtains 2 theoretically separated channel runs on left and right of the outlet – to which only half of the surface is still connected – by means of setting the outlet in the middle of the 8 m channel run. The result per theoretical channel run is only 58 m² of the surface to be drained instead of 116 m². For a given rainfall of 250 l/(s x ha) and the newly chosen surface (57 m²), the result according to the hydraulic table for the Euroline is a maximum possible 120 m length of channel run. Therefore, the total length of 8 m can be achieved without any problem.

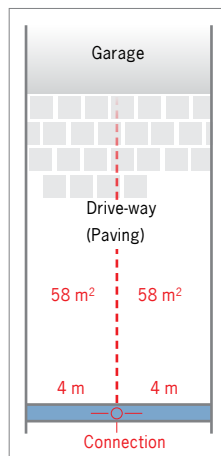

Tip:

You are welcome contact our ACO technical applications advisors by telephoning 09736 41-60 in order to ask questions about the hydraulic calculation.

Halved paved surface of 58 m²; chosen value in the table of: 57 m²; therefore the planned possible channel run is 2 x 4 m = 8 m (max. 120 m).

5. Schritt

Which type of drainage connection has to be chosen must now be finally checked. According to the hydraulic table, a value of 1.0 l can be read off from the amount of water (Q) for this partial surface. This value describes the amount of water that must be conducted away via the outflow in the case that the associated (chosen) figure in square metres is

57. The amount of water (Q) must be doubles because 2 channel runs are connected to one outflow in this case. The result is that the total amount of water is about 2.0 l*. This example shows by comparing with the given amounts of outflow for the individual types of connection (see Table on page 18) that all three versions can be used and that the

surface water can be reliably conducted away. It is indispensable for the system to be regularly cleaned, in order to ensure that the outflow is permanent. Heavy soiling can reduce the outflow's efficiency by more than 50%!

* Alternatively, one can also ascertain the whole amount over the entire surface of course: that would be 116 sq.m. (or 115 sq.m.) or about 2.02 l.

Example 2 Drainage with the slotted channel

Hydraulic length of channel run: 8 m. Assumed rainfall: 300 l/(s*ha). The surface shall be drained with one slotted channel. The amount of water that has to

be set for the slotted channels is Q = 1.0 l/s and it shows the (above mentioned) maximum possible catchment area. If r = 300 l/(s*ha), then the result is the greatest possible connected surface of 48 sq.m. The width of the surface to

be drained can be calculated to be about 6 m, subject to considering 8 m as the planned length of channel run. Therefore, a second channel run ought to be set for a larger area.

Easy installation and the perfect solution

The installation of ACO Self® Euroline with sump units in front of a garage; explained step by step



1. Excavate the soil according to the installing recommendation for ACO Self® Euroline: a channel run with sump units. (Installation details can be downloaded from www.aco-hochbau.de/service/technische-dokumente/).



2. Cut the moulding on the sump unit in the middle with a diamond-tipped disc as shown, in order to connect it to the channel body....



3. and knock it from outside to inside with a hammer.



4. Construct the channel's foundation according to the installing recommendation. Compact the channel's foundation by tamping. Prepare the outflow according to DN 100.



5. Insert the KG pipe with lubricant into the sump unit.



6. Pour bulk concrete onto the already compacted foundation.



7. Put the channel body on the sump unit. Align the channel run. The 2 cm garage threshold is designed and constructed in such a way that the door closes between the clip and the channel.



8. Fit the end cap before setting the last channel body. Also see page 15.



9. Make the lateral concrete connection according to the installing recommendation.



10. Ascertain or stipulate the falling situation. The paving should be positioned in such a way that the channel runs 3 mm to 5 mm underneath the paving.



11. Adjust the paving to suit the channel run.



12. The finished channel run in the paved area in front of the garage. The channel relieves the threshold and it prevents splashing water in the door area.

Installation of the ACO Self® Hexaline – explained step by step.



1. Excavate a trench for the concrete bed. The concrete bed shall subsequently have a minimum size of 5 cm high and 20 cm wide. We also recommend to place the front and back row of paving sets on a concrete bed. (see page 25).



2. Backfill the trench with lean concrete at ground moisture-content (C15 or B 15) and compact it.
3. Strip off the concrete bed to the desired height (82 mm to 85 mm in relation to the surface paving).



Installation video
ACO Self® Hexaline

– If you redesign the surface completely, then stretch and aligning string which has the level of the subsequent surface.
– If the aligning string will be inserted into an existing paving, then make a template at the desired height, e.g., from wood.



4. Hammer out the moulding for drainage at the desired position.

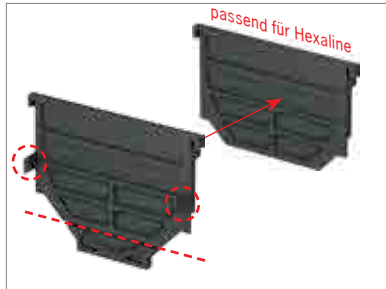

5. Cut off the end cap according to the lettering for an optimal seating. The area that is designated with a 'Y' as well as the two Clips A must be removed.



6. Put the outflow connection on the channel and place the leaf guard on the outflow opening. Place the end cap at the beginning and end of the channel run respectively.



7. Connect the channel components to each other via the tongue-and-groove system.



8. Place the completed channel run in the desired position.



9. Please lay the corresponding components starting from the outflow opening outwards, if the lengths are more than 5 m.



10. You have the possibility of shortening the channel with the plastic grating at any desired position.



11. Adjust the paved surface to suit the channel body. Take care that the channel's top surface lies about 3 mm to 5 mm below the paved surface.



Advice about installing the ACO Self® Highline

Using the channel connector as a brace for stiffening

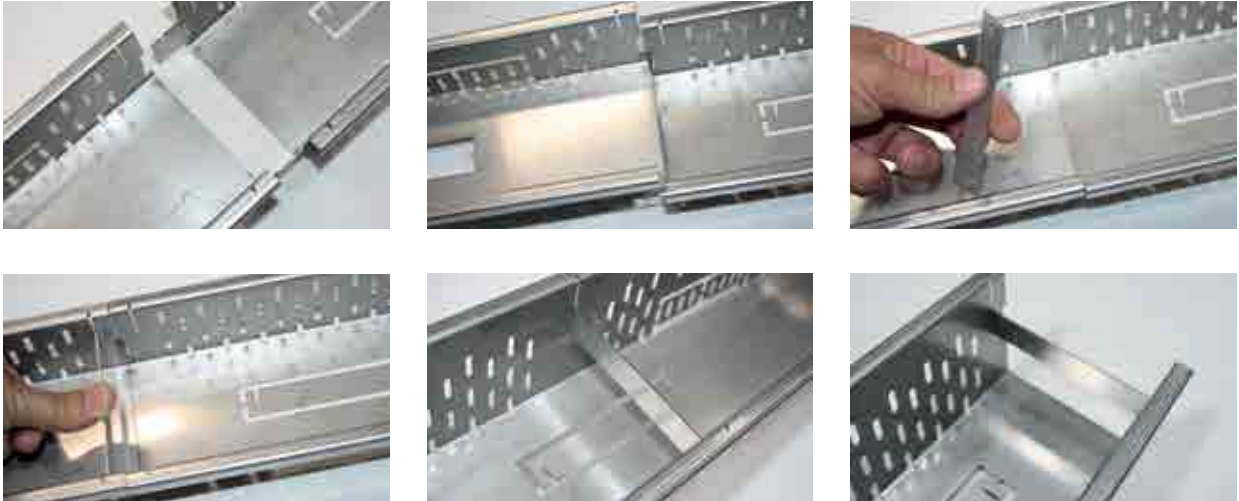

Caution: stiffening the channel!

When using the ACO Self® Highline in a walkable area, 3 braces must be inserted per metre. If the channel is not subjected to any loading from above, then no braces are necessary for stiffening it.

The end cap

Both sides of it can be used and it is fixed with the channel connector.



Bend in the component before inserting it into the end cap.



Advice about installing the ACO Self® Highline

The installation in contact with the soil at the facade

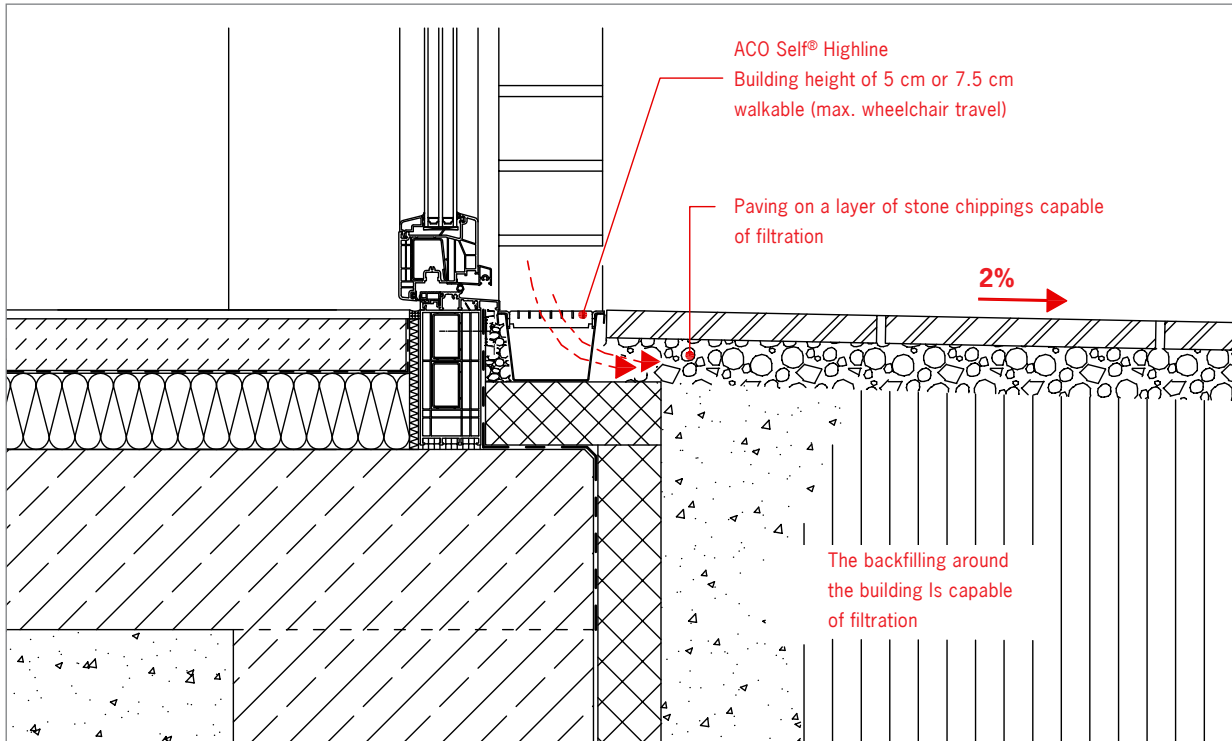

The matter of draining a façade with the ACO Self® Highline concerns an open channel system that allows the falling rainwater to percolate or soak away similarly to a strip of gravel around the house. It must be noted that the impingement of moisture on the basement's wall will increase in certain circumstances as a result.

The installation on balconies

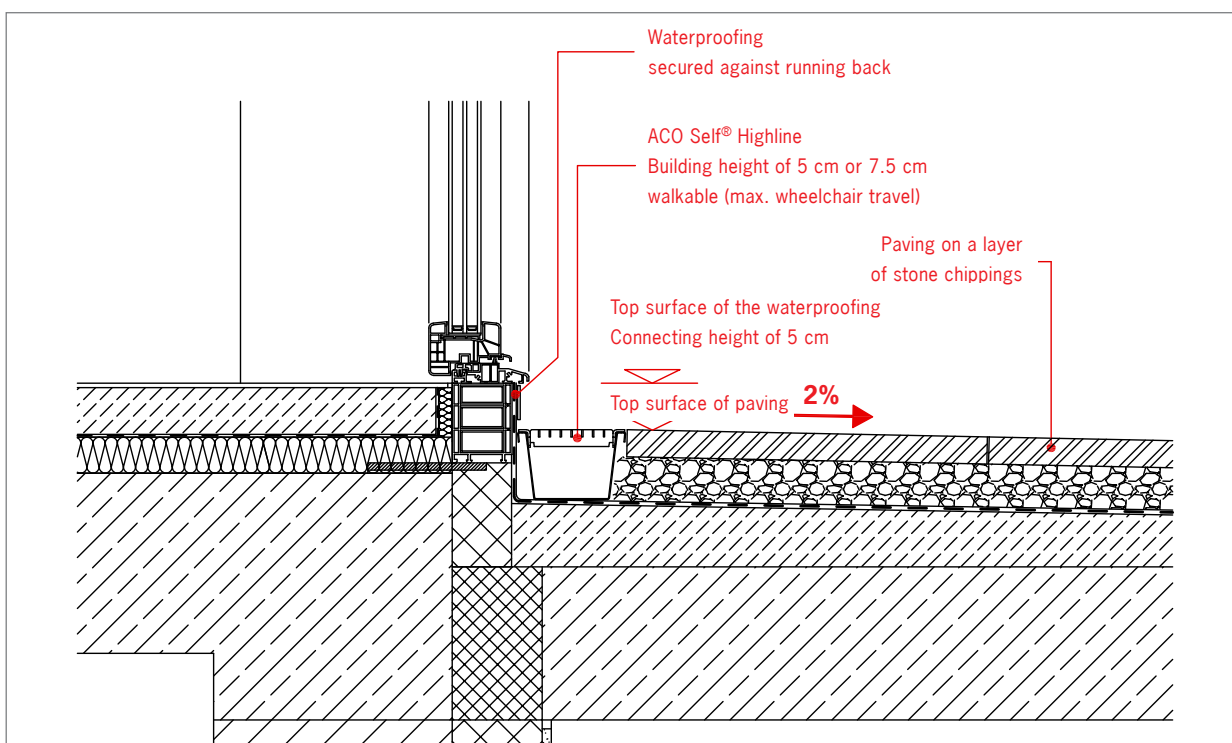

ACO Self® drainage
for you at home.
Versatile. Easy. Attractive.

Slotted grating in
polished stainless steel



Powder-coated straight
grating in the anthracite
colour







Every product from ACO Hochbau supports the ACO system chain

Systematic solutions for the house and basement

- Drainage of swimming pools
- Floor outlets and gullies
- Anti-flooding valves
- Access covers
- Lifting equipment

Infrastructure for the house and garden

- Drainage channels and yard gullies
- Façade channels

ACO Systems FZE

Office, Manufacture & Warehouse
Jebel Ali Free Zone, Street 100, Bldg. 07
P.O. Box 18672, Dubai
United Arab Emirates
Tel. 00971 (0)4 880 69 98 info@aco.ae
Fax 00971 (0)4 880 69 97 www.aco.ae

ACO Hochbau Vertrieb GmbH

P.O. box. 1125,
D 97661 Bad Kissingen
Neuwirtshäuser Strasse 14,
D 97723 Oberthulba/Reith
Tel. 09736 41-60 hochbau@aco.com
Fax 09736 41-52 www.aco-hochbau.de