

Commercial Product Catalog





Innovation Has A Name.

It should come as no surprise that a company that has built its reputation on the concept of innovation continues to lead the industry with the broadest—and, yes, the most innovative—selection of water heaters in its long and storied history.

What *might* come as a surprise to some is the fact that we view this accomplishment as a mere beginning—an indication of even greater things still to come. For everyone here at A. O. Smith, it's never been just about outdoing what we have achieved in the past—it's always been about exceeding everyone's expectations for the future. Which is why you, our customers, can count on us to provide you with the perfect water heater solution for any application—day after day, year after year.

Table of Contents

A. O. Smith Innovation and Quality	3
iCOMM™ and iCOMM™ Elite Remote Monitoring System	4-5
BACnet and Modbus Building Management Systems	6
Gas Water Heaters	8-23
Power Burner Gas Water Heaters	24-26
Oil-Fired Water Heaters	27-29
Commercial Tankless	30-32
Electric Heat Pump Water Heaters	33
Electric Water Heaters	34-39
Automatic Circulating Water Heaters and Boilers	40-52
Ac-U-Temp Hot Water Supply Systems	53-55
Electric Boilers & Hot Water Generators	56-57
Custom Semi-Instantaneous Water Heaters	58
Storage Tanks/Hot Water Generators	60-61
Commercial Line Overview & Support Network	62-63

A. O. Smith innovation and quality...engineered into every product from the inside out.

The Eliminator™ Self-Cleaning Technology In Master-Fit® Models

A. O. Smith Master-Fit commercial gas water heaters have always provided maximum installation flexibility for both new construction and replacement applications. Now, Master-Fit offers The Eliminator for automatic self-cleaning protection against build-up of lime and other sediments.

As deposits of lime and other sediments accumulate inside the tank, they form a barrier between the burner and the water, concentrating heat around the critical weld areas. The result is reduced energy efficiency, higher operating costs, and greater risk of premature tank leaks.

The Eliminator directs incoming cold water under pressure to sweep the bottom of the tank to keep sediment moving so it doesn't accumulate.

With The Eliminator, every Master-Fit water heater can be expected to maintain its rated efficiency longer and deliver reliable service year after year.

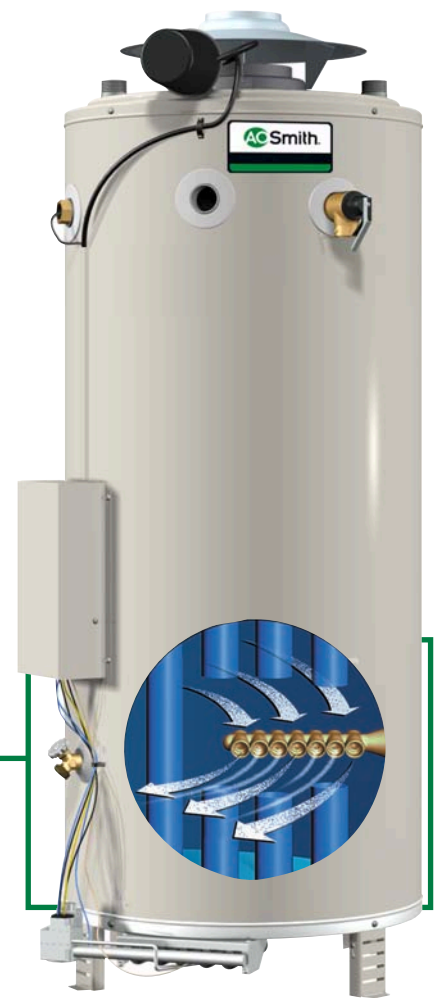

PermaGlas® Ultra Coat™ Glass Coating

Nothing protects like it, and nobody offers it but A. O. Smith. PermaGlas Ultra Coat is an exclusive "slush coat" process that heat-bonds glass to each tank's inner surface after all connections and seams have been welded. Because it's a slush coating process instead of a spray-on coating, PermaGlas Ultra Coat covers and protects better.

And because A. O. Smith PermaGlas Ultra Coat is applied after the tank is welded, there is no chance of "weld burn" that can burn away normal glass lining and expose bare steel to water.

PermaGlas Ultra Coat provides protection for the tank's top, bottom, and outer shell and all weld seams.



All welds completed prior to PermaGlas Ultra Coat.



Once tanks are filled with PermaGlas, they are rotated (computer controlled) for precise, even coating.



Technician removes hand-hole clean-out to prepare it for the next step.



Tanks are then rotated further, allowing the excess PermaGlas to drain from the tank.

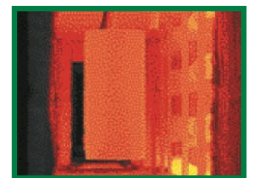

After pre-drying in 200°F ovens, the tanks are then fired to 1,600°F, fusing the PermaGlas to the steel tank.

iCOMM™ Remote Monitoring System

For information and ordering call 1-888-WATER02 or visit www.aosmithconnect.com



Hardware

MODEL NO.	ITEM	DESCRIPTION
ICMA	iCOMM Communications Module	Main communications board required for any iCOMM installation.
IMDA	iCOMM Multi-Device Adapter	Needed if more than one water heater will be connected to the control module. Order one (1) MDA for each water installed.
IABA	iCOMM Alarm Box	Accessory alarm box that includes an audible alarm and alarm light.



Note: If using wireless internet an optional wireless adapter is needed to provide wired connection to the communications module. Recommended adapter Linksys WGA600N or equivalent

iCOMM Features

- Provides remote monitoring via www.aosmithconnect.com
- E-mail and text messaging of fault conditions
- Leak detection and notification
- Graphs unit performance and operational history
- BACnet compatibility with building management systems

iCOMM Requirements

- Facility must have "always on" internet (wired or wireless)
- iCOMM compatible water heater
- Annual iCOMM subscription*

Compatible Units Include:

- Cyclone MXi (BTH models)
- Cyclone® Xi (BTX and BTXL models)
- Custom Xi (DSE models)
- Gold Xi (DVE models)
- Genesis® Domestic Water Heaters and Boilers manufactured between July 2009 and January 2014 (GB/GW Models)
- VF™ Variable Fire Domestic Water Heaters and Boilers manufactured between July 2009 and January 2014 (VB/VW Models)



For information and ordering call
1-888-WATER02 or visit
www.aosmithconnect.com

iCOMM™ *Elite* Monitoring Service

iCOMM™ ELITE

Complete Coverage, Total Peace of Mind

What is iCOMM™ Elite?

iCOMM™ Elite utilizes the latest technology in commercial water heating to allow us to interact with, proactively manage and monitor your A. O. Smith water heaters from anywhere in the world via the Internet. With this newly redesigned industry-exclusive service, A. O. Smith can monitor your water heaters around the clock, alert you instantly in case of a problem, and begin fixing any potential problems immediately. How is that for ultimate peace of mind?

Who is iCOMM Elite Designed For?

Any commercial water heater customers, ranging from small businesses with one water heater to national chain operations with thousands of locations.

Elite Compatible Units Include:

- Cyclone® Xi (BTH models)
- Custom Xi (DSE models)
- Gold Xi (DVE models)

Valet Service on Any Warranty Claim!

Should you experience problems with any products that are still under warranty—it's time for the VIP treatment. We will do everything to get you back on track, and we mean everything. Our complete valet service includes a call before the service, handling all the logistics, repairing the product, and of course, superior service throughout the process.



Get iCOMM™ Elite in **3** Easy Steps

1. Confirm you have a compatible unit.
2. Verify that you have an Internet connection in the same room as the water heater(s).
3. Call 1-888-WATER02 to purchase and arrange installation.

iCOMM™ Subscription (required) per iCOMM Communication Module for Elite services

Note - iCOMM subscription is required to use the "iCOMM Elite service". End user responsible for paying and maintaining annual subscription. Installation and subscription service fees are net prices paid directly by the end user. No distributor discounts are applicable.

Building Management System BACnet and MODBUS Interface

Introducing the BMS gateway for control of A. O. Smith Water Heaters



Models:

ETH-1000
Ethernet connection

XLTR-1000
Serial RS-485 connection

Connect your A. O. Smith water heater to your building management system using the new Millennium control from ICC* (Industrial Control Communications, Inc.)

- Works with Cyclone, McBee DVE, Renton DSE/DVE/DHE 150kW or less
- Use the ICC Control to enable/disable the water heater
- Change Temperature Set points and differentials
- Two models with four different configurations to connect to BACnet and Modbus
- Ethernet and Serial RS-485 versions available
- 2 wire or 4 wire RS-485 Network
- Power can be supplied via the USB cable, as a 7-24 VDC input on the main terminal Block, or via IEEE 802.3af Power over Ethernet (PoE on ETH-1000 only)
- Configure protocols, network characteristics, and client/server object definitions
- Graphically interact with the internal database in real-time via USB connection
- Automatically discover and configure IP settings Ethernet gateways connected to the current subnet
- Update Firmware

ICC ENERGY MANAGEMENT INTERFACES			
PROTOCOL	PART #	CONNECTION TYPE	APPLICATION
BACnet	9910093000	Serial (RS485)	Commercial Gas - Cyclone® BTH and BTX(L)-100
	9910094000		Commercial Electric - DSE, DVE, DHE 150kW or less
	9910099000	Ethernet (IP)	Commercial Gas - Cyclone® BTH and BTX(L)-100
	9910100000		Commercial Electric - DSE, DVE, DHE 150kW or less
Modbus	9910096000	Serial (RS485)	Commercial Gas - Cyclone® BTH and BTX(L)-100
	9910097000		Commercial Electric - DSE, DVE, DHE 150kW or less
	9910102000	Ethernet (IP)	Commercial Gas - Cyclone® BTH and BTX(L)-100
	9910103000		Commercial Electric - DSE, DVE, DHE 150kW or less

- Heater connection wiring supplied with unit
- For questions on this product Call 888-928-3702 Opt 1
- RTU and serial connect via RS-485
- Ethernet and IP connect via RJ-45





BPD Gas Power Direct Vent Models

80% thermal efficiency, ideal for commercial applications and where negative air pressure is a problem



The BPD-75 tank-type commercial gas water heater is intended for applications such as small office buildings and duplex apartment homes. The BPD-75 features a power direct vent design with a factory-installed blower. The blower permits sealed combustion direct vent operation with separate venting and air intake runs from outside the structure. The BPD-75 offers installation versatility by allowing venting and intake runs up to 50 feet, using 3" Schedule 40 PVC pipe. The power direct vent design also eliminates the potential for performance and safety problems caused by negative air pressure, which is found in many commercial applications with inadequate indoor ventilation.

DynaClean™ II Automatic Sediment-Cleaning System

- Specially designed dip tube directs incoming cold water to create turbulence in the tank to reduce lime and sediment build-up
- Prolongs tank life, maintains high energy efficiency, maximizes hot water output

Quiet Modular Blower

- Built-in safety device prevents pilot or main burner operation if blower is not operating
- Blower has 110V/120V electrical system, with maximum 2A draw

Durable Brass Drain Valve

CSA Certified and ASME Rated T&P Relief Valve, Factory-Installed

Meets the Thermal Efficiency and Standby Loss Requirements of U. S. Department of Energy and Current Edition of ASHRAE/IESNA 90.1

Maximum Hydrostatic Working Pressure: 150 PSI

3-Year Limited Tank Warranty



All dimensions in inches

MODEL NO.	GAL. CAP.	BTU INPUT PER HOUR	RECOVERY GPH/°F TEMP. RISE			HT.	DIA.	APPROX. SHIP. WEIGHT
			40	100	140			
BPD-75 Natural	75	70,000	161	64	46	69-5/8	26	352
BPD-75 Propane	75	65,000	148	59	42	69-5/8	26	352

BTF Gas Power Vent Single Flue Models

“Environmentally-Friendly” Non-CFC Foam Insulation

- Minimizes radiant heat loss.

Dip Tube

- Carries inlet water deep into tank.

Hot Surface Ignition

- Has a solid state ignition surface that does not flutter or blow out. Provides increased reliability and efficiency over spark ignition systems. Eliminates the pilot and saves energy.

Intelli-Vent™ Control

- Provides temperature control and LED diagnostics.

Glasslined Tank

- Glass specifically developed by A. O. Smith for water heaters is permanently fused to steel at 1600°F, providing years of corrosion protection and dependable use.

Anode

- Tank-mounted, screw-in replaceable anode for longer tank life.

High Input

- 80,000 BTU input assures plenty of hot water is available by providing faster recovery rates and higher draws.

Burner

- High input, multiport burner for improved combustion and efficiency and meets NOx requirements of less than 40 ng/l.

Turbo Shot™ Combustion System

- Air is precisely drawn through the combustion control port and exhausted through plastic pipe. Controlling the airflow through the heater enhances and regulates the combustion process. In standby mode, the combustion control port restricts air circulation through the heater.

Power Venting

- Provides more venting flexibility and savings. A new quiet blower allows exhaust venting through the roof or sidewall with plastic pipe such as PVC, CPVC, and ABS. Allowable vent lengths of up to 100 equivalent feet make installation easy in any situation. BTF-80 is a Category 3 (positive pressure non-condensing) appliance.

CSA Certified and ASME Rated T&P Relief Valve, Factory-Installed



All dimensions in inches

MODEL NO.	GAL. CAP.	BTU INPUT PER HOUR	RECOVERY GPH/°F TEMP. RISE			HT.*	DIA.	APPROX. SHIP. WEIGHT
			40	100	140			
BTF-80	74	80,000	194	78	55	66-5/16	25-3/8	340

*Height to top of draft hood

Intelli-Vent™ is a Registered Trademark of Emerson Electric Company

BT Gas Models

80% thermal efficiency, ideal for many commercial applications



BT models provide reliable, efficient service for applications such as office buildings and duplex/fourplex apartment homes.

CoreGard™ Anode Rod

- Stainless steel core won't corrode, won't break away

PermaGlas® Glass Lining

- Glass lining and anode rod protect steel tank from corrosion

Fully Automatic Controls

- Includes automatic safety shutoff gas if pilot is extinguished and high temperature energy cutoff (ECO)

Compact Design

- Smaller diameters and shorter heights for greater installation flexibility

Plastic Leg Construction

- Three-leg design

Piezo Ignitor

- Natural gas models only

Burner Head Mounted Pilot

- Natural gas models only

CSA Certified and ASME Rated T&P Relief Valve, Factory-Installed

Meets the Thermal efficiency and standby loss requirements of the U.S. Department of Energy and current edition of ASHRAE/IESNA90.1

3-Year Limited Tank Warranty

5-Year limited Tank Warranty Optional

BT-80 and BT-100



BT-65



All dimensions in inches

MODEL NO.	GAL. CAP.	BTU INPUT PER HOUR	RECOVERY GPH/°F TEMP. RISE			HT.	DIA.	APPROX. SHIP. WEIGHT
			40	100	140			
BT-65	65	65,000*	158	60	45	65	24	215
BT-80	74	75,100	182	73	52	61	27-3/4	275
BT-100	98	75,100	182	73	52	68-1/2	27-3/4	350

* Propane Model rated at 55,000 BTU

80% Thermal Efficiency, ideal for applications requiring Low NOx

Induced Draft Low NOx BTN Gas Models

BTN models are equipped with a blower that produces a power-induced draft of make-up air prior to burner ignition.

Complies with California CEC and TX low NOx and other Air Quality Management Districts with Similar Requirements of less than 40 ng/J

Category 1 Appliance

- Can be commonly vented with other Category 1 appliances and uses standard metal single-wall type "B" vent, connected directly to blower outlet

Factory-Mounted, Pre-Wired Blower

- With 6-foot power cord, provides pre-ignition draft

PermaGlas® Glasslined Tank

- Glass lining and anode rod protect steel tank from corrosion

Intelli-Vent™ Gas Control Valve

- Advanced electronic valve features polarity sensing to help ensure proper operation
- Easy-to-understand diagnostics and a nearly indestructible hot surface ignitor

Certified For Use On Combustible Flooring

Handhole Clean Out

- Allows easy maintenance

3-Year Limited Tank Warranty

5-Year Limited Tank Warranty Optional



All dimensions in inches

MODEL NO.	GAL. CAP.	BTU INPUT PER HOUR	RECOVERY GPH/°F TEMP. RISE			HT.*	DIA.	APPROX. SHIP. WEIGHT
			40	100	140			
BTN-80	74	80,000 (Nat)	193	77	55	66-5/16	25-3/8	300
BTN-80	74	76,000 (LP)	184	74	53	66-5/16	25-3/8	300
BTN-100	98	90,000 (Nat)	218	87	62	71-1/4	26-1/2	350
BTN-100	98	80,000 (LP)	193	77	55	71-1/4	26-1/2	350

* Height to top of the draft hood

Intelli-Vent™ is a Registered Trademark of Emerson Electric Company

BLN Gas Ultra-Low NOx Single Flue Models

80% Thermal Efficiency



The BLN-80 commercial gas water heater complies with California SCAQMD Rule 1146.2 and other Air Quality Management Districts with similar NOx emission requirements of 14 ng/J or 20 ppm. This model is equipped with a pre-wired, factory-mounted blower. This blower provides more efficient control of heat and helps ensure an adequate supply of make-up air. Prior to ignition, the control proves a working draft.

Factory-Installed Blower

- Control proves draft prior to ignition
- No draft hood or barometric damper required
- Blower is factory-mounted with a 6-foot power cord: requires 120V, 3 amp or less electrical system connection

Intelli-Vent™ Gas Control

- Equipped with nearly indestructible silicon nitride hot surface ignitor
- Advanced electronics for precise control of water temperature
- Easy-to-understand system diagnostics

Rated as Category I Appliance

- Category I appliance: uses standard metal, single-wall or "B" type vent
- May be common vented with other Category I appliances
- Vent connects directly to blower outlet

Fully Automatic Control System

- Auto-reset gas shutoff device prevents excessive water temperature
- Adjustable thermostat with 120°F - 180°F range
- Gas pressure regulator

Glasslined Tank

- Exclusive CoreGard™ anode rods with stainless steel core provides additional corrosion protection

Handhole Cleanout

- Allows easy access to tank interior for cleaning

CSA Certified and ASME Rated T&P Relief Valve

3-Year Limited Tank Warranty

MODEL NUMBER	GAL. CAP.	BTU INPUT PER HOUR	RECOVERY			DIMENSIONS IN INCHES		APPROX. SHIPPING WEIGHT (LBS)
			GPH/°F	TEMP. RISE		HEIGHT*	DIAMETER	
BLN-80	74	75,100	182	73	52	65-7/8	25-1/4	300

*Height to top of blower

Intelli-Vent™ is a Registered Trademark of Emerson Electric Company



BL Gas Ultra-Low NOx Single Flue Models

The BL-100 is an Ultra-Low Nox atmospheric vent commercial gas water heater which meets the thermal efficiency and standby loss requirements of the U. S. Department of Energy and Current Edition ASHRAE/IESNA 90.1.

Fully Automatic Control with Safety Shutoff

- Accurate, dependable control system requires no electric connections. Fixed automatic gas shutoff device for added safety. Not recommended for 180°F sanitizing

Heavy Gauge Steel Jacket

- Finished with baked enamel over bonderized undercoat

Glasslined Tank

- Maximizes tank life

Foam Insulation

- Saves fuel, helps reduce standby heat loss

Ultra-Low NOx Emissions

- Complies with SCAQMD Rule 1146.2 and other Air Quality Management Districts with similar requirements of 14 ng/J or 20 ppm

Easy-To-Install

- Completely factory-assembled
- Only gas, water and vent connections need to be made
- All connections are located in front and top of heaters for ease-of-installation and service

Draft Diverter

- Low profile diverter furnished as standard equipment

Maximum Working Pressure - 150 psi

Maximum Gas Inlet Pressure - 14" W.C.

Handhole Cleanout

- Allows easy tank cleaning

3-Year Limited Tank Warranty



MODEL NUMBER	GAL. CAP.	BTU INPUT PER HOUR	RECOVERY GPH/°F TEMP. RISE			DIMENSIONS IN INCHES		APPROX. SHIPPING WEIGHT (LBS)
			40	100	140	HEIGHT*	DIAMETER	
BL-100	98	75,100	184	74	53	70-1/2	27-3/4	350

*Height to top of draft hood

BTR Gas Models

80% thermal efficiency, self-cleaning,
easy to install



ASME
(Optional)



The Master-Fit® BTR series provides outstanding performance and maximum installation flexibility for both new construction and replacement applications. Each unit is designed to be as much as a foot shorter than the models they usually replace, and multiple options for placement of water connections and low installation clearances are additional installer-friendly features.

The Eliminator™ Self-Cleaning System

As deposits of lime and other sediments accumulate inside the tank, they form a barrier between the burner and the water, concentrating heat around the critical weld areas. The result is reduced energy efficiency, higher operating costs, and a greater risk of premature tank leaks. The Eliminator™ directs incoming cold water under pressure to sweep the bottom of the tank to keep sediment moving so it doesn't accumulate. Reduced sediment build-up helps maintain rated thermal efficiency and reduce water heating costs. The self-cleaning system also helps prolong tank life to ensure year after year of reliable service.



Factory-Installed Draft Diverter And Flue Damper

- Low-profile draft diverter helps for installation in tight spaces
- Automatic motorized flue damper helps minimize standby heat loss

Three Water Connection Options

- Hot and cold water connections can be made through front, top or rear of unit
- The Eliminator™ system operates when cold water is connected through front

PermaGlas® Ultra Coat™ Glasslining

- Exclusive process provides superior protection against corrosion
- CoreGard™ anode rods with stainless steel core provide additional corrosion protection

Optional Power Vent Kit Systems

- BTR 120-200 pln 9005381205
- BTR 250-500 pln 9003434205

Intermittent Electronic Ignition

- Eliminates standing pilot, saves energy
- Includes power ON/OFF switch
- Provides flame failure response in less than one second

Meets the Thermal efficiency and standby loss requirements of the U.S. Department of Energy and current edition of ASHRAE/IESNA90.1

CSA Certified and ASME Rated T&P Relief Valve, Factory-Installed

Maximum Hydrostatic Working Pressure: 160 PSI

Fully Automatic Control System

- Manual-reset gas shutoff device prevents excessive water temperature
- Electric temperature control for precise temperature regulation adjustable 120°F–180°F
- Gas pressure regulator and pilot filter

Handhole Clean Out

- Allows easy access to tank interior for cleaning

3-Year Limited Tank Warranty

5-Year Limited Tank Warranty
Optional

Master-Fit®

80% thermal efficiency, ideal for restaurant applications

BTR Gas Models Including Booster Models

The Master-Fit® BTR-151 and BTR-201 are designed for installation in “booster” applications to supply commercial dishwashers with very high temperature water. A booster water heater is normally used in conjunction with a standard water heater delivering hot water at a lower temperature to meet the non-dishwashing needs of a restaurant or other food service application. With 32 gallons stored, these compact units measure only 45” high, and hot and cold water connections can be made in the top, front or rear for installation versatility.

The Features Of The Master-Fit BTR Plus Booster Models:

Built-In Induced Draft Blower

- Produces power-induced draft of make-up air prior to burner ignition
- Provides more efficient control of heat through the flue collector
- No draft hood or barometric damper required

Rated As Category 1 Appliance

- Can be commonly vented with other Category 1 appliances, using standard metal type “B” vent

Meets the Thermal efficiency and standby loss requirements of the U.S. Department of Energy and current edition of ASHRAE/IESNA90.1



NSF leg kit available

All dimensions in inches

MODEL NO.	GAL. CAP.	BTU INPUT PER HOUR	RECOVERY GPH/°F TEMP. RISE			HT.**	DIA.	APPROX. SHIP. WEIGHT	
			40	100	140			STD.	ASME
BTR-120	71	120,000	291	116	83	69-3/4	27-3/4	400	-
BTR-154	81	154,000	373	149	107	73	27-3/4	470	-
BTR-180	81	180,000	434	175	124	67-1/2	27-3/4	470	-
BTR-197	100	199,000	482	193	132	75	27-3/4	603	-
BTR-198	100	199,000	482	193	132	75	27-3/4	603	-
BTR-199	81	199,000	482	193	132	67-1/2	27-3/4	470	-
BTR-200(A)*	100	199,000	482	193	132	72	30-1/4	630	725
BTR-250(A)*	100	250,000	606	242	173	72	30-1/4	630	725
BTR-251(A)	65	251,000	608	243	174	75	27-3/4	750	862
BTR-275(A)*	100	275,000	667	267	90	72	30-1/4	630	725
BTR-305(A)	65	305,000	739	296	211	75	27-3/4	750	862
BTR-365(A)	85	365,000	885	354	243	79-1/2	27-3/4	725	833
BTR-400(A)	100	390,000	945	378	270	75-1/2	30-1/4	760	874
BTR-500(A)	85	500,000	1212	485	346	82-1/4	27-3/4	820	856
BTR BOOSTER MODELS									
BTR-151(A)	32	150,000	364	145	104	45	27-3/4	460	440
BTR-201(A)	32	199,900	485	194	139	45	27-3/4	460	440



Master-Fit®

BTR-120 Models are approved for 5” vent using a 6” to 5” reducer.
 *BTR-250(A), BTR-251(A) and BTR-275(A) models shipped with a 8” to 6” vent reducer.
 Certified for both 6” or 8” vent.
 **Height to top of vent connection.

Master-Fit® BTL Ultra-Low NOx Tank-Type Gas Models

82% Thermal Efficiency



- All Models 82% Thermal Efficiency
- Complies with California SCAQMD Rule 1146.2 and other Air Quality Management Districts with similar requirements of 20 ppm and 14 ng/l Low NOx requirements
- Rated Category 1 Appliance
- Top, Front and Rear Plumbing Connections
- Uses Standard Double Wall Type B Vent
- All Models AHRI Certified
- No Draft Hood or Barometric Damper
- CSA Certified and ASME Rated T&P Relief Valve
- Meets the thermal efficiency and standby loss requirements of the U.S. Department of Energy and current edition of ASHRAE/IESNA 90.1
- Handhole Cleanout
- Eliminator™ Self-Cleaning Feature
- 3-year limited tank warranty

MODEL NUMBER	GALLON CAPACITY	BTU INPUT PER HOUR NATURAL	RECOVERY GPH/°F TEMP. RISE		
			40	100	140
BTL-120	81	120,000	298	119	85
BTL-154	81	154,000	383	153	109
BTL-180	93	180,000	447	179	128
BTL-198	81	199,000	478	191	137
BTL-199	100	199,000	478	191	137
BTL-250	93	250,000	621	248	177
BTL-275	85	275,000	678	271	194
BTL-310	85	310,000	765	306	218
BTL-366	85	366,000	903	361	258
BTL-400	85	390,000	962	385	275
BTL-250(A)	93	250,000	621	248	177
BTL-275(A)	85	275,000	678	271	194
BTL-310(A)	85	310,000	765	306	218
BTL-366(A)	85	366,000	903	361	258
BTL-400(A)	85	390,000	962	385	275

MODEL NUMBER	DIMENSIONS IN INCHES		APPROXIMATE SHIPPING WEIGHT (LBS)
	HEIGHT*	DIAMETER	
BTL-120	68-1/4	27-3/4	750
BTL-154	68-1/4	27-3/4	750
BTL-180	76	27-3/4	835
BTL-198	63-3/4	27-3/4	650
BTL-199	71-3/4	27-3/4	750
BTL-250	76	27-3/4	835
BTL-275	76	27-3/4	850
BTL-310	76	27-3/4	850
BTL-366	76	27-3/4	850
BTL-400	76	27-3/4	850
BTL-250(A)	76	27-3/4	880
BTL-275(A)	76	27-3/4	900
BTL-310(A)	76	27-3/4	900
BTL-366(A)	76	27-3/4	900
BTL-400(A)	76	27-3/4	900



*Height to vent
 Electrical characteristics—120V-60 Hz A. C., 5.0A
 (A) after model number designates ASME construction
 LEG KITS FOR UL SANITATION TO MEET NSF-5 (increases overall height by 3")
 BTL models not available in LP gas
 BTL models for sale in California only

All models are approved for use in combined appliance applications.

BTF-80 Power Vent Single Flue Water Heaters

CFC-Free Foam Insulation

- Minimizes radiant heat loss

Dip Tube

- Carries inlet water deep into tank

Hot Surface Ignition

- Has a solid state ignition surface that does not flutter or blow out
- Provides increased reliability and efficiency over spark ignition systems
- Eliminates the pilot and saves energy

Intelli-Vent Control

- Provides temperature control and LED diagnostics

Glasslined Tank

- Glass specifically developed by A. O. Smith for water heaters is permanently fused to steel at 1,600°F, providing years of corrosion protection and dependable use

Anode

- Tank-mounted, screw-in replaceable anode for longer tank life

High Input

- 80,000 BTU input assures plenty of hot water is available by providing faster recovery rates and higher draws

Burner

- High input, multiport burner for improved combustion efficiency and low NO_x

Turbo Shot™ Combustion System

- Air is precisely drawn through the combustion control port and exhausted through plastic pipe
- Controlling the airflow through the heater enhances and regulates the combustion process
- In standby mode, the combustion control port restricts air circulation through the heater

Powered Venting

- Provides more venting flexibility and savings
- A new quiet blower allows exhaust venting through the roof or sidewall with plastic pipe such as PVC, CPVC, and ABS
- Allowable vent lengths of up to 100 equivalent feet make installation easy in any situation
- BTF-80 is a Category 3 (positive pressure non-condensing) appliance

Approval Ratings and Certification

- All models comply with: ANSI Z21.10.3/CSA 4.3 and ASHRAE/IES 90.1 – 2004
- Meets Texas and other low NO_x areas requiring 40 ng/J

3-Year Limited Tank Warranty



GAS-FIRED



MODEL NUMBER	GALLON CAPACITY	BTU INPUT PER HOUR	RECOVERY GPH/°F TEMP. RISE			DIMENSIONS IN INCHES		APPROX. SHIPPING WEIGHT (LBS)
			40	100	140	HEIGHT*	DIAMETER	
BTF-80	74	80,000	194	78	55	66-5/16	25-3/8	340

*Height to top of draft hood

Intelli-Vent™ is a Registered Trademark of Emerson Electric Company

Induced Draft BTN Gas Models

80% thermal efficiency—
Low NOx



The Master-Fit® Plus BTN series meets Southern California Energy Commission (CEC) and Texas low NOx requirements of less than 40 ng/J and features an induced-draft design. This provides more efficient control of heat through the flue collector. Like all Master-Fit water heaters, the BTN series provides outstanding performance and maximum installation flexibility for both new construction and replacement applications. Each unit is designed to be as much as a foot shorter than the models they usually replace, and multiple options for placement of water connections and low installation clearances are additional installer-friendly features.

The Eliminator™ Self-Cleaning System

As deposits of lime and other sediments accumulate inside the tank, they form a barrier between the burner and the water, concentrating heat around the critical weld areas. The result is reduced energy efficiency, higher operating costs, and a greater risk of premature tank leaks.

The Eliminator™ directs incoming cold water under pressure to sweep the bottom of the tank to keep sediment moving so it doesn't accumulate. Reduced sediment build-up helps maintain rated thermal efficiency and reduce water heating costs. The self-cleaning system also helps prolong tank life to ensure year after year of reliable service.



Built-In Induced Draft Blower

- Factory-mounted on top of unit and pre-wired for easy installation
- Provides power-induced draft of combustion make-up air prior to burner ignition
- Requires no draft hood or barometric damper

Rated As Category 1 Appliance

- An excellent option for retrofit and upgrade installations
- Uses standard metal single-wall type "B" vent, can be commonly vented with other Category 1 appliances
- Vent connects directly to blower outlet

Three Water Connection Options

- Hot and cold water connections can be made through front, top or rear of unit
- The Eliminator™ system operates when cold water is connected through front

PermaGlas® Ultra Coat™ Glass Lining

- Exclusive process provides superior protection against corrosion
- CoreGard™ anode rods with stainless steel core provide additional corrosion protection

Compliance

- Meets the Thermal efficiency and standby loss requirements of the U.S. Department of Energy and current edition of ASHRAE/IESNA90.1
- Models comply with California Energy Commission (CEC) and Texas low NOx and other Air Quality Management Districts with NOx emission requirements of less than 40 ng/J



Control With Silicon Nitride Hot Surface Ignitor

- Digital solid-state diagnostic control system helps make installation and troubleshooting easy
- Digital Temperature Control adjusts thermostat setting from 120°F to 180°F, accurate to within ±2°F
- Control includes Power On/Standby Indicator, ECO Open Indicator, Reset Status Indicator and Heating Mode Indicator
- Silicon nitride ignitor is rugged and dependable, equipped with separate flame prover rod
- Manual-reset gas shutoff device prevents excessive water temperature

CSA Certified and ASME Rated T&P Relief Valve, Factory-Installed

Intermittent Electronic Ignition With Solid-State Ignition Control

- Eliminates standing pilot, saves energy
- Includes power ON/OFF switch
- Provides flame failure response in less than one second

Maximum Hydrostatic Working Pressure: 160 PSI

Handhole Clean-Out

- Allows easy access to tank interior for cleaning

Plug Kits

- Pipe nipples and caps included to plug unused water connections

3-Year Limited Tank warranty

5-Year Limited Tank Warranty Optional

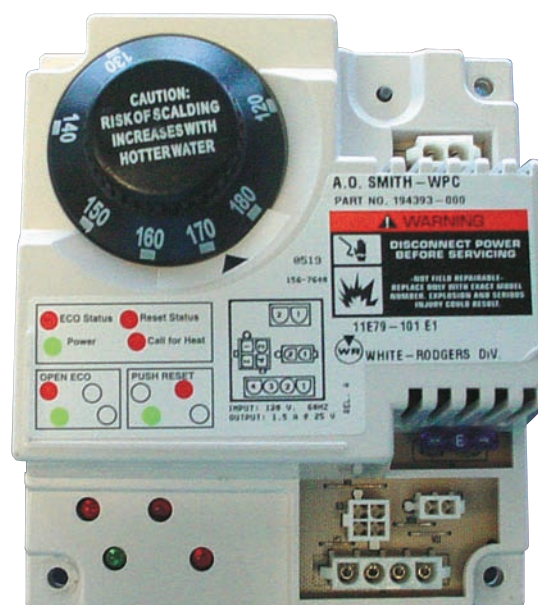

All dimensions in inches

MODEL NUMBER	GALLON CAPACITY	BTU INPUT PER HOUR	RECOVERY			DIMENSIONS IN INCHES		APPROX. SHIPPING WEIGHT (LBS)	
			GPH/°F	TEMP. RISE		HEIGHT	DIAMETER	STANDARD	ASME
BTN-120	71	120,000	289	115	82	63	27-3/4	520	-
BTN-154	81	154,000	371	148	106	68	27-3/4	550	-
BTN-180	99	180,000	433	173	124	72	27-3/4	550	-
BTN-199C	99	199,000	479	192	137	72	27-3/4	620	-
BTN-199	99	199,000	479	192	137	72	27-3/4	550	-
BTN-200(A)	100	199,000	479	192	137	72	27-3/4	660	710
BTN-250(A)	100	250,000	602	241	172	72	27-3/4	600	710
BTN-270(A)	100	275,000	662	265	189	72	27-3/4	660	710
BTN-310(A)*	100	310,000	746	298	213	73	27-3/4	720	770
BTN-366(A)	85	366,000	881	352	252	73	27-3/4	830	880
BTN-400(A)	85	390,000	938	375	268	73	27-3/4	830	880

*Models meet 82% TE Utility Rebate.
BTN-199C models for sale in California only.

Cyclone® Mxi BTH and BTX Gas Models

Up to 98% thermal efficiency,
venting flexibility, outstanding value

Cyclone Mxi MODULATING

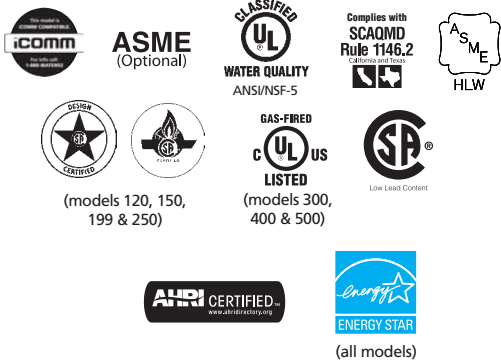

The full line of A. O. Smith Cyclone condensing water heaters has been designed to provide years of dependable service with its industry leading technology. Models are available from 100,000 to 500,000 Btu/h and provide up to 98% thermal efficiency. The unique helical coil heat exchanger minimizes weld joints for optimal life while maximizing heat transfer.

Cyclone is the industry leader in high efficiency commercial water heating with over a quarter million of them sold since 1997.

The current Mxi modulating models adjust firing rate to the customers' specific demand further increasing efficiency and money savings.

Submerged Combustion Chamber, With Helical Heat Exchanger Coil

- Positioned in center of tank, surrounded by water to virtually eliminate radiant heat loss from chamber
- Spiral heat exchanger maximizes efficiency of heat transfer to the water stored in the tank
- Top mounted burner and spiral heat exchanger work together to minimize harmful effects of calcium/lime accumulation

PermaGlas® Ultra Coat™ Glass Lining

- Exclusive process provides superior protection against corrosion in varying water conditions
- Both sides of heat exchanger coil are glasslined for optimum protection

Intelligent Control System with LCD Display

- iCOMM™ Compatible and can be monitored from remote locations. Call 1.888.WATER02 for more information
- Provides detailed water heater status information
- Precise temperature control
- Built-in diagnostics
- Run history information

Various Venting Options

- Power Vent and sealed-combustion power venting (vertical or sidewall)
- Direct vent intake and exhaust pipe can terminate separately outside building or through single opening using concentric vent assembly
- Uses inexpensive PVC, CPVC, ABS or Polypropylene. Also approved for use with AL29-4C stainless vent pipe



Unrivaled Venting Versatility

The Cyclone features power-vent and power direct vent design, allowing combustion air to be drawn from the equipment room conventionally or directly from the outdoor atmosphere through a sealed intake air pipe. Vent systems can be terminated vertically through the ceiling or horizontally through a sidewall. Front located exhaust and condensate connections allow for easy installation and serviceability

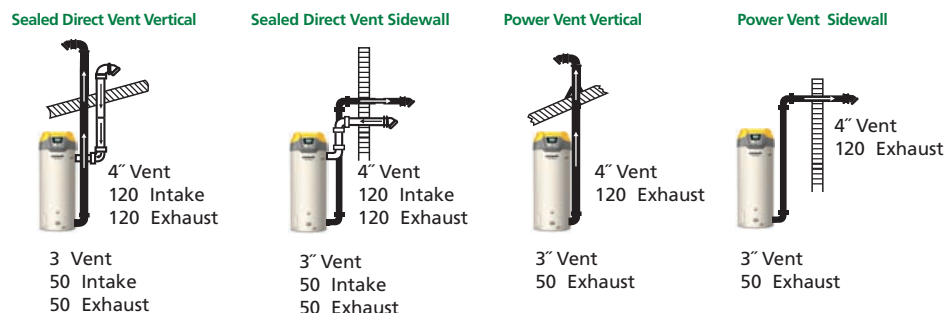

*Above illustrations apply to BTH-120 through BTH-250 models only.
 4" PVC pipe is required for the BTH300-500 up to 70 equivalent feet, and 6" PVC pipe is required for vent lengths beyond 70 equivalent feet.
 See instruction manual for complete venting instructions and allowable vents lengths.

Space-Saving Design For Installation Flexibility

- Top cover has rear cut-away for easy access to serviceable parts
- 0" installation clearances on sides and rear, 1-1/2" installation clearance on top
- 0" clearance to combustibles (walls, floors, etc.)

Powered Anodes (Excluding BTX-100 Models)

- No maintenance required (non-sacrificial)
- Superior tank protection
- Adjusts to water conditions

High Efficiency Modulating Pre-Mix Powered Burner (excluding BTX80 models)

Down-fired pre-mix burner provides optimum efficiency and quiet operation. Top-mounted burner position prevents condensation from affecting burner operation



All dimensions in inches



MODEL NO.	GALLON CAPACITY	RECOVERY CAPACITY GPH 100°F RISE	VENT SIZE	INPUT BTU/HR NATURAL GAS	HT.	DIA.	APPROX. SHIP. WEIGHT
BTH-120	60	138	3	120,000	53-1/2	27-3/4	460
BTH-150	100	178	3	150,000	75-3/4	27-3/4	523
BTH-199	100	235	3	199,000	75-3/4	27-3/4	523
BTH-250	100	291	3	250,000	75-3/4	27-3/4	523
BTH-300	119	349	4	300,000	75-3/4	33-1/8	855
BTH-400	119	465	4	399,900	75-3/4	33-1/8	855
BTH-500	119	576	4	499,900	75-3/4	33-1/8	855
BTH-120A	60	138	3	120,000	53-1/2	27-3/4	490
BTH-150A	100	178	3	150,000	75-3/4	27-3/4	553
BTH-199A	100	235	3	199,000	75-3/4	27-3/4	553
BTH-250A	100	291	3	250,000	75-3/4	27-3/4	553
BTH-300A	119	349	4	300,000	75-3/4	33-1/8	855
BTH-400A	119	465	4	399,900	75-3/4	33-1/8	855
BTH-500A	119	576	4	499,900	75-3/4	33-1/8	855
BTX-100	50	116	4	100,000	66-3/4	22	255
BTXL-100	75	116	2 or 3	100,000	64-3/4	27-3/4	382

Cyclone® HE BTX-80

76,000 BTU, 90%
thermal efficiency



The 50-gallon power vent Cyclone HE is designed to produce more hot water than any commercial gas water heater in its class. Thanks to the internal helical heat exchanger—similar to the design of the industry-leading Cyclone Mxi models—the unit achieves 90% thermal efficiency. With its small footprint and easy installation, Cyclone HE delivers heavy-duty performance for numerous light-duty smaller applications, making it a perfect choice for restaurants, offices and other applications.

Helical Coil Heat Exchanger

- Submerged heat exchanger provides much greater heat transfer surface than standard straight flue tube
- Produces 90% thermal efficiency, which saves money on operating costs, and increases hot water output compared to standard-efficiency water heaters

Versatile Power Vent Design

- System allows combined vertical and horizontal vent runs, using 2, 3 or 4" PVC, ABS, Polypropylene or CPVC pipe

Modular Blower

- A condensate drain supplied to connect heat exchanger outlet to blower
- PVC Vent Attenuation Assembly (VAA) supplied for applications where extra-quiet operating environment is essential

High Output With Small Footprint

- 22" diameter, combined with 90% efficiency, 76,000 BTU input means Cyclone HE can be installed in less space than a larger 75-gallon unit with equal or better performance

PermaGlas® Ultra Coat™ Glass Lining

- A. O. Smith exclusive process provides superior protection against corrosion
- Protects all interior tank surfaces including inside and outside of helical heat exchanger

Intelli-Vent™ Gas Control

- Equipped with long-lasting silicon nitride hot surface ignitor—no standing pilot
- Advanced electronics for more precise control of water temperature and simplified system diagnostics
- 180°F maximum temperature setting

Side-Mounted Hot And Cold Recirculating Taps

- Allows Cyclone HE to be installed as part of combination space heating/water heating applications, or any system requiring a recirculating hot water loop
- Plugs for the recirculating taps are factory installed

Two Heavy-Duty Anode Rods

- Provide advanced protection against corrosion



Superior Heat Transfer

By utilizing the innovative internal heat exchanger coil, the Cyclone HE provides superior heat transfer characteristics, resulting in an unprecedented 90% thermal efficiency, far beyond a standard water heater design. Gallon for gallon, the Cyclone HE will heat water for significantly less, resulting in substantial savings on energy costs.

With as much power as larger water heaters in a standard 50-gallon footprint, the Cyclone HE is the natural choice for upgrading during a renovation. And the versatile power vent design allows combined vertical and horizontal vent runs of up to 128 equivalent feet. Cyclone HE provides superior savings on energy costs.

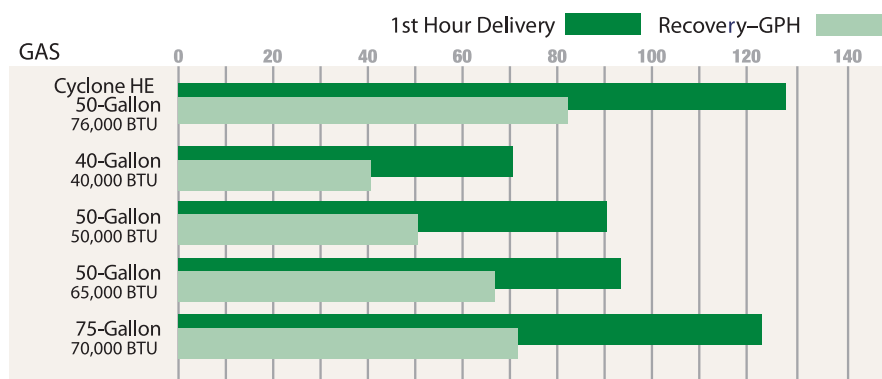

The classic Cyclone helical heat exchanger coil delivers 90% thermal efficiency.

All dimensions in inches

MODEL NUMBER	GAL. CAP.	BTU INPUT PER HOUR NATURAL GAS	RECOVERY GPH/°F TEMP. RISE			DIMENSIONS IN INCHES		APPROX. SHIPPING WEIGHT (LBS)
			40	100	140	HEIGHT*	DIAMETER	
BTX-80	50	76,000	206	83	59	68-1/4	22	210

*Height to top of the heater
Available in Natural Gas only

SUGGESTED SPECIFICATION

Natural gas water heater shall be A. O. Smith Cyclone, HE model # BTX-80, with 90% thermal efficiency, a storage capacity of 50 gallons, an input rating of 76,000 BTU per hour, a recovery rating of 83 gallons per hour at 100°F rise and a maximum hydrostatic working pressure of 150 PSI. Water heater(s) shall be of power vent design, using 2, 3 or 4" PVC pipe for horizontal and/or vertical vent runs.

Large- Volume Power Burner BTP & BTPN Gas Models

BTP-150-140 through BTP-600-2500
BTPN 150-300 through BTPN-600-2500



ASME

The high-volume power burner line includes the largest, most powerful A. O. Smith tank-type gas water heaters. With tank capacities up to 600 gallons and firing capacities up to 2.5 million BTU per hour, these large-volume high-output water heaters are capable of producing over 3,000 gallons (GPH) of hot water per hour at an 80°F rise. These heavy-duty industrial-grade water heaters are designed and built to handle the most demanding hot water heating requirements of large commercial and industrial users.

Power Gas Burner

- Suitable for natural or propane gas
- Electronic flame safeguard control with intermittent spark ignition
- Main and pilot automatic gas valves with gas pressure regulators
- Diaphragm air switch for proof of blower operation
- Flame inspection port

Fully Automatic Controls With Safety Shutoff

- High-temperature limit control (manual reset)
- CSA Certified and ASME Rated T&P Relief Valve
- Hinged-door control compartment for easy access
- Upper and lower thermostats for accurate temperature control
- Standard control is for 120°F-180°F water service
- Factory-installed low-water cutoff

Blue Diamond® Glass Lining

- Blue Diamond glass coating provides superior corrosion resistance compared to the industry-standard glass lining
- Equipped with multiple anode rods for additional corrosion protection

Heavy-Duty Jacket

- Heavy-gauge steel jacket with baked powder-coated finish for durability
- Two 3" handhole inspection openings

Maximum Hydrostatic Working Pressure

- All models: 160 PSI

Professional Start-Up Service Included

- Required for activating warranty and assuring quality performance

Codes And Standards

- Design-certified by UL (Underwriters Laboratories), according to ANSI Z21.10 standards
- Meets the thermal efficiency and standby loss requirements of the U.S. Department of Energy and current edition of ASHRAE/IESNA 90.1

Optional Low NOx Burners

- Low NOx burners from 300,000 BTUH up to 2 million BTUH
- Complies with Texas and other low NOx areas requiring 40 ng/l or 30 ppm

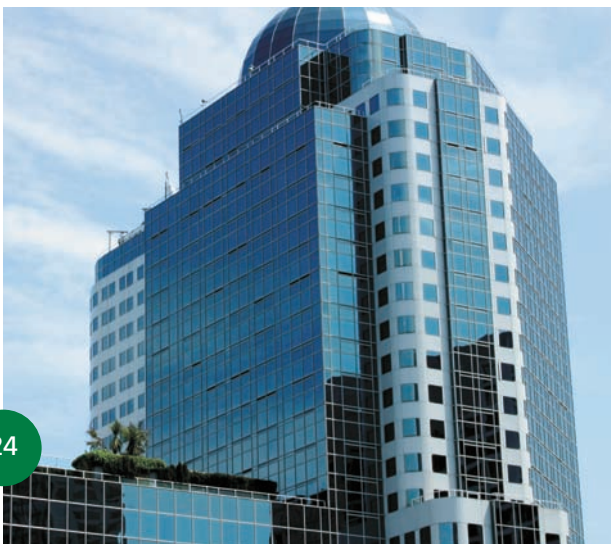

Large- Volume Power Burner BTP & BTPN Gas Models

BTP Options:

- Factory-approved mutual control arrangement
- 5 or 10-year extended limited warranty
- High or low water pressure switch
- AGA-rated T&P valve
- Modular graphic burner systems management on heaters with 270,000 BTU input and over
- Low NOx burner available on select models

Three-Year Limited Tank Warranty

- For complete information, consult written warranty or contact A. O. Smith

Other BTP Features:

- Two layers of high-temperature ceramic fiber insulation in combustion chamber
- Flame inspection port opening
- Mounted on rugged channel iron skids
- National board stamping
- ASME-rated temperature and pressure gauge
- Low-water cutoff
- Barometric draft regulator
- 120V control circuit
- Drain valve
- 180°F water service thermostats

All dimensions in inches

MODEL NO.	GAL. CAP.	INPUT BTU/HR NATURAL GAS	TEMP. RISE °F-GPH RECOVERY CAPACITY			MOTOR HP 120V 60 HZ 1 PHASE	VENT SIZE	HT.	DIA.	DEPTH	APPROX. SHIP. WEIGHT
			80	100	140						
BTP-150-140	150	140,000	170	136	97	1/17 HP 2.5 AMPS	5	82-1/4	36-1/2	48	1292
BTP-150-199	150	199,000	241	193	138	1/17 HP 2.5 AMPS	6	82-1/4	36-1/2	48	1292
BTP-150-255	150	255,000	359	247	176	1/17 HP 2.5 AMPS	6	82-1/4	36-1/2	48	1292
BTP-150-270	150	270,000	327	262	187	1/4 HP 4.6 AMPS	6	82-1/4	36-1/2	57-1/2	1397
BTP(N)-150-400†	150	400,000	485	387	277	1/4 HP 4.6 AMPS	7	82-1/4	36-1/2	57-1/2	1397
BTP(N)-150-540†	150	540,000	654	524	374	1/4 HP 4.6 AMPS	8	82-1/4	36-1/2	57-1/2	1505
BTP-150-720	150	720,000	873	698	499	1/3 HP 5.5 AMPS	10	82-1/4	36-1/2	57-1/2	1510
BTP-200-300	200	300,000	364	291	208	1/4 HP 4.6 AMPS	6	84-1/2	44-3/4	66-1/2	2098
BTP-200-600	600	600,000	737	582	416	1/4 HP 4.6 AMPS	8	84-1/2	44-3/4	66-1/2	2098
BTP(N)-200-800†	200	800,000	970	776	554	1/3 HP 5.5 AMPS	10	84-1/2	44-3/4	66-1/2	2103
BTP(N)-200-1000†	200	1,000,000	1212	970	693	1/3 HP 5.5 AMPS	10	84-1/2	44-3/4	66-1/2	2103
BTP(N)-200-1250†	200	1,250,000	1515	1212	866	1/2 HP 7.4 AMPS	12	84-3/4	44-3/4	66-1/2	2467
BTP-200-1500†	200	1,500,000	1818	1455	1039	1/2 HP 7.4 AMPS	12	84-3/4	44-3/4	66-1/2	2675
BTP-300-300	300	300,000	364	291	208	1/4 HP 4.6 AMPS	6	92	44-3/4	66-1/2	2150
BTP-300-600	300	600,000	727	582	416	1/4 HP 4.6 AMPS	8	92	44-3/4	66-1/2	2150
BTP(N)-300-800†	300	800,000	970	776	554	1/3 HP 5.5 AMPS	10	92	44-3/4	66-1/2	2308
BTP(N)-300-1000†	300	1,000,000	1212	970	693	1/3 HP 5.5 AMPS	10	92	44-3/4	66-1/2	2308
BTP(N)-300-1250†	300	1,250,000	1515	1212	866	1/2 HP 7.4 AMPS	12	92	44-3/4	66-1/2	2584
BTP(N)-300-1500†	300	1,500,000	1816	1455	1039	1/2 HP 7.4 AMPS	12	92	44-3/4	81-1/2	2774
BTP-400-600	400	600,000	727	582	416	1/4 HP 4.6 AMPS	8	89	55	76-1/2	3207
BTP(N)-400-800†	400	800,000	970	776	554	1/3 HP 5.5 AMPS	10	89	55	76-1/2	3212
BTP(N)-400-1000†	400	1,000,000	1212	970	693	1/3 HP 5.5 AMPS	10	89	55	76-1/2	3212
BTP(N)-400-1250†	400	1,250,000	1515	1212	866	1/3 HP 5.5 AMPS	12	89	55	76-1/2	3212
BTP(N)-400-1500†	400	1,500,000	1816	1455	1039	1/2 HP 7.4 AMPS	12	89	55	91-1/2	3402
BTP(N)-400-1750†	400	1,750,000	2121	1697	1212	1/2 HP 7.4 AMPS	14	89	55	91-1/2	3528
BTP(N)-400-2000†	400	2,000,000	2424	1939	1385	1/2 HP 7.4 AMPS	14	96-1/4	55	91-1/2	3669
BTP-500-2250	500	2,250,000	2727	2182	1558	3/4 HP 10.2 AMPS	16	108	55	91-1/2	4277
BTP-500-2500	500	2,500,000	3030	2424	1732	3/4 HP 10.2 AMPS	16	108	55	91-1/2	4419
BTP-600-720	600	720,000	873	698	499	1/3 HP 5.5 AMPS	10	114	55	76-1/2	3667
BTP(N)-600-1000†	600	1,000,000	1212	970	693	1/3 HP 5.5 AMPS	10	114	55	76-1/2	3667
BTP(N)-600-1250†	600	1,250,000	1515	1212	866	1/3 HP 5.5 AMPS	12	114	55	76-1/2	3667
BTP(N)-600-1500†	600	1,750,000	1816	1455	1039	1/2 HP 7.4 AMPS	12	114	55	91-1/2	3837
BTP(N)-600-1750†	600	1,750,000	2121	1697	1212	1/2 HP 7.4 AMPS	14	114	55	91-1/2	3837
BTP(N)-600-2000†	600	2,000,000	2424	1939	1385	1/2 HP 7.4 AMPS	14	114	55	91-1/2	3837
BTP-600-2250	600	2,250,000	2727	2182	1558	3/4 HP 10.2 AMPS	16	114	55	91-1/2	4477
BTP-600-2500	600	2,500,000	3030	2424	1732	3/4 HP 10.2 AMPS	16	114	55	91-1/2	4619

†Models with an (N) are available in low NOx (include the "N" in the model number when ordering).

Power Burner Water Heaters

Power burner models provide thermal efficiencies of 80%



ASME

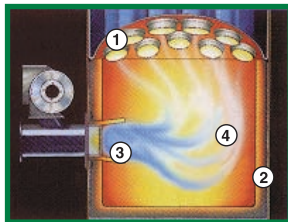

These gas power burner models provide an outstanding thermal efficiency of 80% or more and are suitable for commercial applications.

Small Volume BTP Quality Features:

- UL listed power burner
- ASME construction
- CSA Certified and ASME rated T&P relief valve
- Handhole cleanout(s) for easy maintenance
- Three-year limited tank warranty
- Fully automatic controls ensure safe, efficient operation
- Barometric draft damper ensures correct airflow in the vent
- Factory Start-up Included, required for activating warranty and assuring quality performance
- Mounted on rugged channel iron skids for easy transport during installation
- Multiple anodes for extra protection against tank corrosion
- Flame inspection port opening for visual inspection of flame characteristics during operation
- Spark pilot ignition
- Factory-installed burner for easy installation
- BTP(V) 540 and 650 comply with SCAQMD 1146.2 of 14 ng/J or 20 ppm. The 740 complies with Texas and other areas of 20 ng/J or 30 ppm. Other units are not low NOx applicable.
- Meets the Thermal efficiency and standby loss requirements of the U.S. Department of Energy and current edition of ASHRAE/IESNA90.1
- Contact Canadian customer service for availability in Canada
- 3-year limited tank warranty

Options (Not Available On All Models)

- 5-year limited tank warranty
- 3 vent options: atmospheric, sidewall and direct vent

Shown here is the power burner combustion chamber used in the BTP-540A, BTP-650A & BTP-740A models. These models can vent through a side wall up to 100 ft. without an external blower.

1. **Exclusive PermaGlas® Ultra Coat™ Glasslined Tank** protects tank surfaces and all welds from the corrosive effects of hot water.
2. **Proylite 3100 Chamber Wall** retains heat, ensuring cool operation and maximum heat transfer to water, not the room.
3. **Premix Combustion System** provides super clean low-NOx flame. Helps eliminate hot spots and uneven heat transfer.
4. **Sealed Combustion Chamber** reduces heat loss.

All dimensions in inches

MODEL NO.	GAL. CAP.	RECOVERY CAPACITY/GPH 100°F RISE	VENT SIZE	INPUT BTU/HR NATURAL GAS	HT.	DIA.	APPROX. SHIP. WEIGHT
BTP-139	86	136	6	140,000	74 3/4	27 3/4	556
BTP-199	86	193	6	199,000	74 3/4	27 3/4	545
BTP-270	86	262	8	270,000	74 3/4	27 3/4	547
BTP-370	75	359	8	370,000*	74 3/4	27 3/4	634
BTP-139A	86	136	6	140,000	74 3/4	27 3/4	658
BTP-199A	86	193	6	199,000	74 3/4	27 3/4	635
BTP-270A	86	262	8	270,000	74 3/4	27 3/4	632
BTP-370A	75	359	8	370,000*	74 3/4	27 3/4	731
BTP(V)-540A*	85	523	9	540,000	93	29 1/2	950
BTP(V)-650A*	85	630	9	650,000	93	29 1/2	950
BTP(V)-740A*	85	718	9	740,000	93	29 1/2	950

*Available with optional horizontal sidewall or sealed direct vent termination kits (specified at time of order).



COF models provide thermal efficiencies of 80%

Duraclad Oil-Fired Small Volume Models

Our Duraclad COF-199 and larger models have an optional two-stage pump for use with below-grade oil storage tanks. Features include two handhole clean-outs for easy servicing. The large volume COBT models are available as a dual-fuel heater—natural gas as well as oil-fired.

Small Volume COF Quality Features:

- For small to medium-sized applications
- UL listed oil burner
- 180°F adjustable thermostat
- Single-stage oil pump for simple, efficient operation.
- Solenoid oil valve (standard on 455, 700)
- 3/4" drain valve
- CSA Certified and ASME rated T&P relief valve
- Two handhole clean-outs (COF-385 and larger, and ASME models) for easy maintenance.
- Barometric draft regulator provided for proper operation, ensures correct flow in the vent
- Foam insulation
- Intermittent ignition
- CoreGard™ anode rod with stainless steel core won't corrode, won't break off
- Flame observation port
- PermaGlas® glasslined tank with 160 PSI maximum working pressure
- 3-year limited tank warranty

Options

- Two-stage pump for use with underground oil storage tanks
- Oil solenoid safety valve
- ASME construction available on models COF-315 and larger
- 5-year limited tank warranty



All dimensions in inches

MODEL NO.	GAL. CAP.	BTU INPUT PER HOUR	TEMP. RISE DEG. R-GPH			HT.	DIA.	DEPTH	APPROX. SHIP. WEIGHT	
			40	100	140				STD	ASME
COF-199S	86	199,000	482	193	138	74-3/4	24-3/4	37	553	NA
COF-245S	86	245,000	594	238	170	74-3/4	24-3/4	37	554	NA
COF-315S	84	315,000	764	305	218	74-3/4	24-3/4	37	554	657
COF-385S	75	385,000	933	373	267	74-3/4	24-3/4	37	624	742
COF-455S	75	455,000	1103	441	315	74-3/4	24-3/4	37	700	747
COF-700S	69	700,000	1697	679	485	79-1/2	24-3/4	37	739	822

*Based on No. 2 fuel oil.
All models have 1/8 HP motor.

Change S to A in the model number for ASME construction, e.g. COF-700A

Heavy-Duty Oil-Fired COF/COBT Models

Large Volume High Output Oil and Dual Fuel Water Heaters



COF models offer oil fuel burners (No. 1 or 2 oil). COBT models feature combination gas/oil powered burners for the versatility of operating with natural gas/propane and No. 1 or 2 oil. COF/COBT models include some of the largest and most powerful A. O. Smith tank-type water heating systems available – with storage/input options up to 600 gallons/2,500,000 BTU/hour and recoveries as high as 2,424 gallons/hour at 100°F rise. All models feature fully automatic controls with safety shutoff, two thermostats (upper and lower) for accurate temperature control, and ASME tank construction.

COF (Oil-Fired Models)

- Use either No. 1 or 2 fuel oil
- 3450 rpm motor
- Multi-annular fuel containment combustor head
- Oil ignition transformer
- Integral 2-stage fuel unit and oil safety valve

COBT (Combination Gas/Oil-Fired Models)

- Use either natural gas or propane and No. 1 or 2 fuel oil
- 3450 rpm motor
- Multi-annular fuel containment combustor head
- Gas/electric pilot and gas ignition transformer
- Pilot and main pressure regulators
- Air safety switch
- Manual fuel-selector switch
- Integral two-stage fuel unit

Fully Automatic Controls With Safety Shutoff

- High temperature limit control (manual reset)
- CSA Certified and ASME rated T&P relief valve
- Hinged-door control compartment for easy access
- Upper and lower thermostats for accurate temperature control

Blue Diamond® Glass Lining

- Blue Diamond coating provides superior corrosion resistance compared to industry-standard glass lining
- Equipped with multiple anode rods for additional corrosion protection

Heavy-Duty Jacket

- Heavy gauge steel jacket with baked powder-coated finish for durability
- Two 3" handhole inspection openings

Maximum Hydrostatic Working Pressures

- All COF and COBT models: 160 PSI

Compliance

- Meets the Thermal efficiency and standby loss requirements of the U.S. Department of Energy and current edition of ASHRAE/IESNA90.1

Professional Start-Up Service Included

- Required for activating warranty and assuring quality performance



Two Layers Of High Temperature Ceramic Fiber Insulation In Combustion Chamber

Flame Inspection Port Opening

Mounted On Rugged Channel Iron Skids

ASME Stamping

Low-Water Cutoff

3-Year Tank Limited Warranty

COF/COBT Options

- Factory mutual approved control arrangement
- 5-year or 10-year extended limited warranty
- High or low water pressure switch
- 180°F water service thermostats
- CSA certified and ASME rated T&P relief valve
- Modular graphic burner systems management on heaters with 270,000 BTU input and greater

All dimensions in inches

MODEL NO.	GAL. CAP.	INPUT BTU/HR	OIL FLOW RATE	TEMP. RISE °F-GPH RECOVERY CAPACITY			COBT MOTOR HP 1 Ø 120V	COF MOTOR HP 1 Ø 120V	VENT SIZE	HT.	DIA.	DEPTH	APPROX. SHIP. WEIGHT		
				80	100	140									
COF-150-140	150	140,000	1	170	136	97	1/3 HP 5.5 AMPS	1/7 HP 4.4 AMPS	5	82-1/4	36-1/2	47	1292		
COF-150-199	150	199,000	1.4	241	193	138			6	82-1/4	36-1/2	47	1292		
COF-150-255	150	255,000	1.8	359	247	176			6	82-1/4	36-1/2	47	1292		
COF-150-270	150	270,000	1.9	327	262	187	1/3 HP 5.5 AMPS	1/4 HP 4.6 AMPS	6	82-1/4	36-1/2	57-1/2	1397		
COBT-150-350	150	350,000	2.2	420	339	242			7	82-1/4	36-1/2	57-1/2	1397		
*COF/COBT-150-400	150	400,000	2.8	485	387	277			7	82-1/4	36-1/2	57-1/2	1397		
COF/COBT-150-540	150	540,000	3.8	654	524	374			8	82-1/4	36-1/2	57-1/2	1505		
COF/COBT-150-720	150	720,000	5.1	873	698	416			10	82-1/4	36-1/2	57-1/2	1510		
*COF/COBT-200-300	221	300,000	2.1	354	291	208			1/3 HP 5.5 AMPS	1/3 HP 5.5 AMPS	6	84-1/2	44-3/4	66-1/2	2098
COF/COBT-200-600	221	600,000	4.2	727	582	416					8	84-1/2	44-3/4	66-1/2	2098
COF/COBT-200-800	221	800,000	5.7	970	776	554					10	84-1/2	44-3/4	66-1/2	2103
COF/COBT-200-1000	201	1,000,000	7.1	1212	970	866					10	84-1/2	44-3/4	66-1/2	2103
COF/COBT-200-1250	201	1,250,000	8.9	1515	1212	866					12	84-3/4	44-3/4	66-1/2	2467
COF/COBT-200-1500	201	1,500,000	10.7	1818	1455	1039	12	84-3/4			44-3/4	81-1/2	2675		
*COF/COBT-300-300	300	300,000	2.1	364	291	208	3/4 HP 10.2 AMPS	1/3 HP 5.5 AMPS	6	92	44-3/4	66-1/2	2150		
COF/COBT-300-600	300	600,000	4.2	727	582	416			8	92	44-3/4	66-1/2	2150		
COF/COBT-300-800	300	800,000	5.7	970	776	554			10	92	44-3/4	66-1/2	2308		
COF/COBT-300-1000	300	1,000,000	7.1	1212	970	693			10	92	44-3/4	66-1/2	2308		
COF/COBT-300-1250	300	1,250,000	8.9	1515	1212	866	3/4 HP, 10.2 AMPS		12	92	44-3/4	66-1/2	2584		
COF/COBT-300-1500	300	1,500,000	10.7	1816	1455	1039	1/3 HP 5.5 AMPS	1/3 HP 5.5 AMPS	12	92	44-3/4	81-1/2	2774		
COF/COBT-400-600	411	600,000	4.2	727	582	416			8	89	55	76-1/2	3207		
COF/COBT-400-800	411	800,000	5.7	970	776	554			10	89	55	76-1/2	3212		
COF/COBT-400-1000	411	1,000,000	7.1	1212	970	693			10	89	55	76-1/2	3212		
COF/COBT-400-1250	411	1,250,000	8.9	1515	1212	866	3/4 HP 10.2 AMPS		12	89	55	76-1/2	3212		
COF/COBT-400-1500	397	1,500,000	10.7	1816	1455	1039		12	89	55	91-1/2	3402			
COF/COBT-400-1750	397	1,750,000	12.5	2121	1697	1212		14	89	55	91-1/2	3528			
COF/COBT-400-2000	397	2,000,000	14.2	2424	1939	1385		14	96-1/4	55	91-1/2	3669			
COF/COBT-500-2250	375	2,250,000	16.0	2727	2182	1558	1 HP 16 AMPS		16	108	55	91-1/2	4277		
COF/COBT-500-2500	375	2,500,000	17.8	3030	2424	1732		16	108	55	91-1/2	4419			
COF/COBT-600-720	594	720,000	5.1	873	698	499	1/3 HP 5.5 AMPS	1/3 HP 5.5 AMPS	10	114	55	76-1/2	3667		
COF/COBT-600-1000	594	1,000,000	7.1	1212	970	693			10	114	55	76-1/2	3667		
COF/COBT-600-1250	594	1,250,000	8.9	1515	1212	866	3/4 HP 10.2 AMPS		12	114	55	76-1/2	3667		
COF/COBT-600-1500	594	1,500,000	10.7	1816	1455	1039		12	114	55	91-1/2	3837			
COF/COBT-600-1750	594	1,750,000	12.5	2121	1697	1212		14	114	55	91-1/2	3837			
COF/COBT-600-2000	594	2,000,000	14.3	2424	1939	1385		14	114	55	91-1/2	3837			
COF/COBT-600-2250	575	2,250,000	16.0	2727	2182	1558	1 HP 16 AMPS		16	114	55	91-1/2	4477		
COF/COBT-600-2500	575	2,500,000	17.8	3030	2424	1732		16	114	55	91-1/2	4619			

*COBT models are 350,000 BTU

Tankless Non-Condensing Models

Continuous Maximum Flow Rates Up To 6.6 GPM



ULTRA-LOW NO_x MODELS

Fully modulating, gas fired, tankless water heater with sealed combustion and power-vented flue. Indoor and outdoor models available for residential applications. Supplies hot water to domestic hot water systems (directly or indirectly) which can be used with storage tanks, recirculation systems, hydronic heating systems, radiant floor heating systems, and/or combined domestic & heating applications.

ENERGY STAR® Qualified

Available in Natural Gas or Propane (LP)

Outdoor Models Include Remote Control as a Standard Feature

Indoor Models Include Both a Remote Control and Power Cord as Standard Features

Low NO_x and Ultra-Low NO_x Emissions

Safety Features:

- Built in Freeze Protection
- Manual Reset Hi Limit (Set at 194°F)
- Overheat Cutoff Fuse
- Inlet and Outlet Thermistors for Constant Temperature Monitoring
- Flue Backdraft Pressure Switch
- GFI Power Supply Connection
- Flame Sensor

10-Year Limited Tank Warranty



MODEL NUMBER*	TYPE	BTU INPUT NATURAL/PROPANE		HOT WATER OUTPUT (GPM)		
		MINIMUM	MAXIMUM	MAX.	45°F RISE	70°F RISE
ATI-510-N*	Indoor	11,000	199,000	10.0	7.2	4.7
ATO-510-N*	Outdoor	11,000	199,000	10.0	7.2	4.7
ULTRA-LOW NO_x						
ATI-510U-N*	Indoor	15,000	199,000	10.0	7.2	4.7
ATO-510U-N*	Outdoor	15,000	199,000	10.0	7.2	4.7

MODEL NUMBER*	ENERGY FACTOR (EF)	DIMENSIONS IN INCHES		
		HEIGHT	WIDTH	DEPTH
ATI-510-N*	0.82	20-1/4	13-3/4	9-1/2
ATO-510-N*	0.82	20-1/4	13-3/4	9-1/2
ULTRA-LOW NO_x				
ATI-510U-N*	0.82	20-1/4	13-3/4	9-1/2
ATO-510U-N*	0.82	20-1/4	13-3/4	9-1/2

*Models can be installed in residential applications, recirculation applications, and easy-link up to 4 units. For Propane (LP), change the "N" to "P" in the model number when ordering: Example: ATI-510-P
Ultra-Low NO_x models are available in Natural Gas only



Ultra-Low NOx Condensing Technology
 Provides Significant Energy Cost Savings –
 Unprecedented 0.95 Energy Factor

Tankless High Efficiency Condensing Models

All Models are ENERGY STAR® Qualified

Ultra-Low NOx Condensing Technology
 Provides Significant Energy Cost Savings -
 Unprecedented 0.95 Energy Factor

Durable HRS35 Commercial-Grade Copper
 Primary Heat Exchanger

Type 316L Stainless Steel Secondary
 Heat Exchanger

Electronic Ignition - No Pilot Light

Indoor Model has Built-in Temperature
 Controller and Diagnostics

Complies with Lead Free Standards

10-Year Limited Warranty on Heat Exchanger /
 5-Year Limited Parts Warranty



MODEL NUMBER*	TYPE	BTU INPUT NATURAL/PROPANE		HOT WATER OUTPUT (GPM)		
		MINIMUM	MAXIMUM	MAX.	45°F RISE	70°F RISE
ATI-540H-N	Indoor	15,000	199,000	10.0	8.4	5.4
ATO-540H-N	Outdoor	15,000	199,000	10.0	8.4	5.4

MODEL NUMBER*	ENERGY FACTOR (EF)	DIMENSIONS IN INCHES		
		HEIGHT	WIDTH	DIAMETER
ATI-540H-N	0.95	23-5/8	17-3/4	11-1/4
ATO-540H-N	0.95	23-5/8	17-3/4	11-1/4

*For Propane, change the N to P Example: ATI-540H-P



Tankless Heavy-Duty Models

MODEL 710



MODEL 910

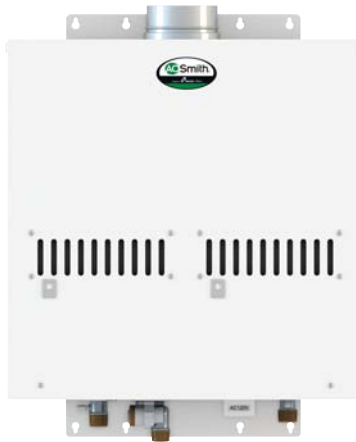

HRS35 Commercial-Grade Copper Heat Exchanger (non-ASME models)

ASME Models Available

Category III Stainless Steel Venting - 4" for 710 models and 5" for 910 models

Vertical or Horizontal Venting Installation

Power Vent Design

Electronic Ignition

Low NOx Emissions

Combined Indoor/Outdoor models

Easy-Link up to 4 Units

Multi-Link up to 20 Units (710 Models only)

Multi-Link Up to 10 Units (910 Models)

10-year limited warranty on heat exchanger / 5-year limited parts warranty

MODEL NUMBER	FUEL TYPE	BTU INPUT NATURAL/PROPANE		HOT WATER OUTPUT (GPM)		
		MINIMUM	MAXIMUM	MAX.	45°F RISE	70°F RISE
ATIO-710-N	Convertible	24,000	240,000	9.0	8.5	5.5
ATIO-710-AN*	Convertible	24,000	240,000	9.0	8.5	5.5
ATIO-910-N	Convertible	15,000	380,000	14.5	13.5	8.7
ATIO-910-AN*	Convertible	15,000	380,000	14.5	13.5	8.7

MODEL NUMBER	THERMAL EFFICIENCY NG / LP	DIMENSIONS IN INCHES		
		HEIGHT	WIDTH	DEPTH
ATIO-710-N	82% / 84%	23-3/5	18-1/2	10
ATIO-710-AN*	82% / 84%	23-3/5	18-1/2	10
ATIO-910-N	80% / 82%	24-7/8	25-1/4	12-1/4
ATIO-910-AN*	80% / 82%	24-7/8	25-1/4	12-1/4

For Propane, change the N to P Example: ATIO-710-P
*ASME models



Air-to-Water heat pump water heaters remove unwanted heat and humidity from the surrounding air and use it to heat water. The refrigeration-based system produces cool, dehumidified air for spot cooling or to reduce the load on air conditioning system.

Air-to-Water Heat Pump Water Heater Options:

- High Efficiency water heating
- "Environmentally-Friendly" Green Technology uses non-ozone depleting R-134a refrigerant
- Simplified Installation
- Efficient Scroll Compressor
- Coefficient of Performance (COP) between 3.9 and 4.2 for water heating
- Standard 208/230 VAC, 3 phase power (optional 460 VAC, 3 phase)
- Sanitary hot water for commercial or industrial uses
- Maximum 140°F final tank temperature at common indoor temps



Accessories Include:

- Digital Temp Controller with Tank Probe
- Metal Mesh Cleanable Filter
- Corrosive Duty Package; 316 stainless steel cabinet phenolic coated evaporator coil and blower housing. Recommended for coastal areas.

All dimensions in inches

MODEL NUMBER	PERFORMANCE					DIMENSIONS				APPROXIMATE SHIPPING WEIGHT (LBS.)
	WATER HEATING BTUH*	COOLING CAPACITY BTUH*	AIR VOLUME CFM**	C.O.P.	G.P.M.	INLET/OUTLET (FPT)	WIDTH	DEPTH	HEIGHT	
AWH-35	35,500	27,500	1040	3.9	7	1.0"	40"	26"	24-3/4"	315
AWH-55	58,000	45,500	1650	4.1	11	1.0"	47"	32"	28-1/2"	405
AWH-75	76,000	59,000	2150	3.9	15	1.5"	57"	32"	28-1/2"	485
AWH-100	98,000	78,000	3200	4.2	20	1.5"	63"	38"	42-1/2"	660
AWH-115	113,000	89,000	3200	4.2	23	1.5"	63"	38"	42-1/2"	665
AWH-140	142,000	110,000	3800	3.9	28	2.0"	63"	38"	42-1/2"	725
AWH-170	171,000	133,000	4900	3.9	34	2.0"	75"	46"	42-1/2"	880

*Performance rating at 75° F, 55% Relative Humidity and 100° incoming water temperature

**Blower design at 0.3" external static pressure

C.O.P. coefficient of performance

All models standard 208/230V, 3-phase, 60 Hz

Optional 460v 3ph 60Hz

Optional 240v 1ph 60Hz (available on AWH-35 and AWH-55 only)

DEN/DEL Electric Dura-Power™ Models



The Dura-Power™ DEN (standard upright) and DEL (lowboy) series is available with tank capacities from 6 through 119-gallons. They can be installed for non-simultaneous and single element operation (maximum input up to 6 kW), or for simultaneous dual-element operation (maximum input up to 12 kW).

Zinc-Plated Copper Sheath Heating Elements Standard

- Medium-watt density design disperses element temperature over larger surface contact area to minimize scale build-up, maximize efficiency and prolong element life
- Element options from 1.5 kW to 6 kW (non-simultaneous or simultaneous operation), recovers from 6 GPH to 49 GPH at 100°F rise

Standard Voltages For Easy Installation

- 120V, 277V single-phase, and 208V, 240V and 480V unbalanced 3-phase delta
- Easily converted to single-phase at terminal block (except for 208V with 6000W elements)
- Single-element heater, single-phase only (see chart for dual-element options)

Factory-Installed Terminal Block

- Provide electrical service to heater and connect to block (not supplied on 120V and 277V models)

Factory-Wired Controls

- Temperature control (adjustable from 110°F to 170°F on single element; 120°F to 180°F on dual-element models)
- Manual reset high temperature cutoff per element (dual-element models)
- Factory-wired for non-simultaneous operation; easily converted to simultaneous operation (3-phase models only)

Glasslined Tank

- Provides long-lasting protection against corrosion
- Equipped with anode rod for additional protection against corrosion

Compliance

- Meets the standby loss requirements of the U.S. Department of Energy and current edition of ASHRAE/IESNA90.1

Maximum Hydrostatic Working Pressure: 150 PSI

3-Year Limited Tank Warranty

- 5-year limited tank warranty optional

All dimensions in inches

MODEL NO	GAL . CAP.	KILOWATTS MAXIMUM	HEIGHT	DIA.	APPROX SHIP WEIGHT
DEL MODELS					
DEL-6S	6	3	15-1/2	14-1/4	35
DEL-10S	10	6	18-1/4	18	54
DEL-15S	15	6	26	18	58
DEL-20S	20	6	22-1/4	21-3/4	73
DEL-30D	30	12	30-7/8	21-3/4	100
DEL-40D	40	12	32-1/4	24	125
DEL-50D	50	12	32-1/4	26-1/2	166
DEN MODELS					
DEN-30D	30	12	34-1/2	20-1/2	98
DEN-40D	40	12	45-1/8	20-1/2	113
DEN-52D	50	12	54-7/8	20-1/2	131
DEN-66D	66	12	60-3/4	21-3/4	176
DEN-80D	80	12	59-3/8	24	211
DEN-120D	119	12	62-7/16	29-3/8	326

*S denotes Single Element D denotes Dual Element



DRE/DVE Electric Gold and Gold Xi

Gold and Gold Xi DRE/DVE series available with 50, 80, and 119 gallon storage tanks, with input choices ranging from 6 kW to 54 kW. They can be used as recovery heaters for hot water supply service or as boosters for supplying sanitizing rinse water for dish washing.

Goldenrod® 24k gold-plated Elements Standard

- Superior scaling resistance, resulting in long term efficiency and damage protection
- Element sizes from 2 kW to 6 kW using 3, 6 or 9 elements provide input options from 6 kW to 54 kW, recovers from 25 GPH to 221 GPH at 100°F rise

Power Circuit Fusing For System Protection

- Safeguards elements and contactors from short circuits, overloading and line surges
- Meets National Electrical Code requirements that non-ASME tanks must have internal fusing when current draw exceeds 48 amps

208, 240 and 480V Options For Easy Installation

- Single-phase and 3-phase delta
- Field-convertible voltages 3-phase to single-phase (and vice versa) except for 208V/54 kW
- 277V single-phase also available

Factory-Installed Terminal Block

- Provide electrical service to heater and connect to block

3-Year Limited Tank Warranty

- 5-year limited tank warranty optional

Other Standard DRE/DVE Features

- Two anode rods for maximum corrosion protection
- Simplified circuitry, color coded for ease of service
- Bonderized undercoated baked enamel finished cabinets

- Brass Drain Valve
- CSA/ASME temperature and pressure relief valve

Compliance

- Meets the standby loss requirements of the U.S. Department of Energy and current edition of ASHRAE/IESNA90.1

DRE Gold Model Controls

- DRE Gold models have surface mount temperature controls adjustable 120° to 180°F.
- Manual reset high-temperature cutoff

DVE Gold Xi Model Features

Advanced Electronic Controls

- iCOMM™ Compatible and can be monitored from remote locations. Call 1.888.WATER02 for more information.
- Plain English text and animated icons.
- Displays detailed operational and diagnostic information
- Fault or alert messages appear if an operational issue occurs
- Last 9 fault and alert messages saved with time stamp.

Heavy-Duty Magnetic Contactors

- UL-rated 100,000 cycles

Economy Mode Operation

- Control system automatically lowers the operating set point by a programmed value during user-defined time periods

- Helps reduce operating costs during unoccupied or low demand periods

Precise Temperature Regulation

- Operating Set Point adjustable 90° to 190°F
- Banks of heating elements (3 elements per bank) are energized according to adjustable (1° to 20°) differential set points for each bank. Helps reduce short cycling and operating costs by matching kW output to load conditions
- Linear sequencing - first bank on is last bank off
- Helps reduce current surge/spikes and avoid peak demand charges
- Helps reduce operating costs during low load conditions
- Manual reset high-temperature cutoff



DRE Model

DVE Model

All dimensions in inches

MODEL NO.	GAL. CAP.	KILOWATTS MAXIMUM	HEIGHT	DIA.	APPROX. SHIP WEIGHT	
					STD.	ASME
DVE/DRE-52	50	54	55-3/4	21-3/4	265	316
DVE/DRE-80	80	54	60-1/4	25-1/2	280	325
DVE/DRE-120	119	54	62-1/4	29-1/2	390	416

See specification sheets or contact your local rep for optional kW's available.



(DVE Models Only)



ASME/CRN
(optional)

Heavy-Duty Custom Xi Electric DSE Models

The heavy-duty Custom Xi DSE series is available with storage capacities from 5 to 119 gallons. All tanks feature ASME tank construction. With input choices as high as 90 kW on 50 through 119 gallon models, the DSE Custom Xi series can be used for maximum-demand hot water supply service or as boosters for supplying sanitizing rinse water for dish washing.

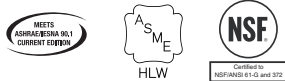

Optional Goldenrod® 24-carat gold-plated elements resist lime scale adhesion and sheath temperatures up to 1500°F.



Incoloy Sheath Heating Elements Standard

- Industrial-grade Incoloy sheathed heating elements are designed for rugged long-lasting commercial service, and can withstand sheath temperatures up to 1500°F
- Each heating element has three separate heating loops, which provides more heating surface, lower watt density and maximum recovery efficiency
- Prewired leads provide excellent protection against oxidation and scaling
- Input options from 3 kW to 90 kW, recoveries from 12 GPH to 369 GPH at 100°F rise

Standard Voltages For Easy Installation

- Single-phase and 3-phase
- Single-phase 208V and 240V are field-convertible to 3-phase
- All 208V and 240V at 24 kW and below are supplied as phase-convertible units (single-to 3-phase and vice versa)
- 277V single-phase also available (Contact A. O. Smith for 120V circuit availability)
- International voltages also available (check with factory)

Factory-Installed Terminal Block (units with more than one contactor)

Advanced Electronic Controls

- iCOMM™ Compatible and can be monitored from remote locations. Call 1.888.WATER02 for more information.
- Plain English text and animated icons
- Displays detailed operational and diagnostic information
- Fault or alert messages appear if an operational issue occurs.
- Last 9 fault and alert messages saved with time stamp.

Progressive Sequencing

- First heating element on is first heating element off.
- First heating element energized is rotated with each successive heating cycle on models with multiple heating elements.
- Evens out wear between heating elements.

Economy Mode Operation

- Control system automatically lowers the operating set point by a programmed value during user-defined time periods.
- Helps reduce operating costs during unoccupied or low demand periods

Precise Temperature Regulation

- Operating Set Point adjustable 90° to 190°F.
- Sequencing - Units with multiple element contactors are sequenced on with one second delay between stages. Adjustable modulating mode is optional.
- Helps reduce current surge / spikes and avoid peak demand charges.
- Manual reset high temperature cutoff.

Heavy-Duty Magnetic Contactors

Power Circuit Fusing For System Protection

Glasslined Tank, with ASME Construction

CSA Certified and ASME Rated T&P Relief Valve

Compliance

- Meets the standby loss requirements of the U.S. Department of Energy and current edition of ASHRAE/IESNA90.1

Brass Drain Valve

3-Year Limited Tank Warranty

- 5-year limited tank warranty optional

All dimensions in inches

MODEL NO.	GAL. CAP.	MAXIMUM		HEIGHT	DIA.	APPROX. SHIP WEIGHT
		KILOWATTS	IMMERSION HEATERS			
DSE-5	5	3	1	20-1/2	16-1/4	100
DSE-10	10	6	1	26-1/2	18-3/4	116
DSE-20	20	18	2	27-1/4	20-1/2	145
DSE-30	30	24	2	35-3/4	20-1/2	168
DSE-40	40	36	2	45-3/4	20-1/2	206
DSE-50	50	90	5	54-3/4	20-1/2	235
DSE-65	65	90	5	50-1/2	26-1/2	280
DSE-80	80	90	5	49-1/4	28	300
DSE-100	100	90	5	58-1/4	28	354
DSE-120	119	90	5	63-1/4	30	430



Heavy-Duty CMC/SU Booster Electric Dura-Power™ Models

The Dura-Power™ commercial electric water heaters are designed to boost the water temperatures for applications such as commercial dishwashers, which require very high temperature sanitizing rinse...typically 180°F. Both 5-gallon countermount CMC models and 20-gallon SU models are available with inputs up to 54 kW. All models are also available with an optional stainless steel tank, for use with deionized water.

Incoloy-Sheath Heating Elements Standard

- Industrial-grade Incoloy sheathed heating elements are designed for rugged long-lasting commercial service and can withstand sheath temperatures up to 1500°F
- Each heating element has three separate heating loops, which provides more heating surface, lower watt density and maximum recovery efficiency
- Pre-wired leads provide excellent protection against oxidation and scaling
- Input options from 6 kW to 54 kW recovers from 62 GPH to 554 GPH at 40°F rise
- Deionized models equipped with stainless steel standard elements

A. O. Smith Goldenrod® Elements Optional

- Patent-pending 24K gold-plated sheath plus medium-watt density ensures even longer element life
- 600% higher resistance to scale build-up, compared to Incoloy elements
- Three-year warranty against failure due to lime scale build-up
- Not available on deionized models

Standard Voltages For Easy Installation

- Single-phase and 3-phase
- Single-phase 208V and 240V are field-convertible to 3-phase
- CMC models only, 208V and 240V at 24kW and below are supplied as phase-convertible units (single- to 3-phase and vice versa)
- 277V single-phase also available (Contact A. O. Smith for 120V circuit availability)

Immersion Thermostat For Efficient Control

- Close differential, immersion-type thermostat for superbly accurate temperature control
- Adjustable from 140°F to 185°F
- Manual reset, high-temperature cut-off

Power Circuit Fusing For System Protection

- Safeguards elements and contactors from short circuits, overloading and line surges
- Required by National Electric Code and UL when current draw exceeds 120A

Heavy-Duty Magnetic Contactors

- UL-rated 100,000 cycles

Factory-Wired 120V Circuit Controls

- 120V control circuit powered by fused transformer
- Eliminates need for 120V service connection

Compliance

- Meets the standby loss requirements of the U.S. Department of Energy and current edition of ASHRAE/IESNA90.1



ASME

Optional Goldenrod® 24-carat gold-plated elements resist lime scale adhesion and sheath temperatures up to 1500°F.



All dimensions in inches

MODEL NO.	GAL. CAP.	NO. OF IMMERSION HEATERS	INLET/OUTLET	HT.	WIDTH	DEPTH	APPROX. SHIP WEIGHT
CMC-6 thru 18	5	1	3/4	13-3/4	13	21-3/4	80
CMC-20 thru 54	5	2*	3/4	12	18	22-1/2	96
SU-6 thru 18	20	1	3/4	25	22-1/4	23	200
SU-20 thru 54	20	2*	3/4	25	22-1/4	23	200

*CMC-54 and SU-54 could have up to three immersion heaters.

Heavy-Duty Premium Electric DVE/DHE Dura-Power™ Models



Dura-Power™ commercial electric water heaters are built to the same high-quality standards as our gas models. These are the largest commercial electric's we manufacture. Ideal for use as recovery heaters for all types of large commercial and industrial applications or for large process potable hot water requirements. They can be customized to meet any special application with the large selection of available options.

Advanced Electronic Control (All Models 150 kW and Down)

A. O. Smith's new proprietary electronic water heater control, provides precise + or - 1°F temperature control, that is ideal for industrial and food service applications where exact temperatures of hot water are needed.

- **Plain Text** – Animated icons display detailed operational and diagnostic information. Fault or Alert messages appear if an operational issue occurs.
- **Low Water Cut Off** – Factory standard on board low water cut-off uses a remote electronic immersion type probe to prevent energizing of the elements in the event of low water condition and eliminates accidental dry firing.
- **Progressive Modulating (only available on units 150 kW or less)** – Sizes the input of available elements to match current load conditions. Rotates and lead lags element loads to provide long life and equal wear.
- **Economy Mode Operation (only available on units 150 kW or less)** – Control system automatically lowers the operating set point by a programmed value during user defined time periods. Seven-day clock may be programmed for night set back and or weekend shutdown to reduce operating cost and save money.
- **iCOMM™ Compatible** – Units can be monitored from remote locations. Call 1.888.WATER02 for more information. Note: Up to 150 kW only. Units above 150 kW use analog controls.

Solid State Modulating Step Control (All Models 180 kW and up)

- Solid state electronic control device that modulates input to match load through progressive sequencing of steps (up to 20 steps with maximum of one per contactor).

Glasslined Tank

- Tank interior is coated with glass specially developed for use in water heaters. Tanks rated at 125 psi working pressure; 150 psi or 160 psi working pressure is optional. Vermin proof fiber glass insulation reduces costly heat loss. Constructed to Section IV of ASME code, and UL standards. Tanks have channel skid base. A 4" x 6" handhole is furnished on 500, 600 and 700-gallon models; 11" x 15" manhole is furnished on 800-gallon and larger sizes.

Incoloy Immersion Heaters

- Heavy-duty medium watt density elements (three immersion heater) have incoloy sheathing: provide excellent protection against oxidation and scaling. The input ranges from 15kW to 3000kW.

Fusing

- Control and power circuit fusing to meet N.E.C.

Compliance

- Meets the standby loss requirements of the U.S. Department of Energy and current edition of ASHRAE/IESNA 90.1.

Magnetic Contactor(s)

- Heavy duty UL rated for 100,000 cycles.

Other Standard Features

- Color-coded circuitry for easier servicing
- Anode rods for maximum corrosion protection
- Standard voltages include 208, 240, 480, 600 volt single or three-phase.
- For other voltages consult factory.
- Factory-installed terminal block(s)
- Cabinet has baked enamel finish
- Prewired element terminal leads
- Temperature and pressure relief valve
- 2" dial temperature gauge

Optional Dual-Energy Source Capability

- Provides emergency back up energy source or winter / summer boiler operation. Can be specified with optional water to water or steam to water heat exchangers. Both single and double wall heat exchangers are available. Complete control packages can be factory-installed for hook up and run capability.

Limited Warranty Outline

- 3-Year Limited Tank Warranty
- Optional 5-Year Limited Tank Warranty
- If the tank should leak any time during the first three years, under the terms of the warranty, A. O. Smith will repair or replace the heater; installation, labor, handling repair or replace the heater; installation, labor, handling and local delivery extra. **THIS OUTLINE IS NOT A WARRANTY.** For complete information, consult the written warranty or A. O. Smith Water Products Company. Warranty does not apply to product installed outside of the United States of America or its territorial possessions and Canada.



Optional Goldenrod® 24-carat gold-plated elements resist lime scale adhesion and sheath temperatures up to 1500° F.



Options

■ Tank Linings

CEMENT – A special formulation of cement providing excellent corrosion protection. Available on 200-gallon and larger tanks.

EPOXY – A solventless two component epoxy lining applied to a minimum ten-mil (.010”) dry thickness. Available on 200-gallon and larger tanks.

■ **GOLDENROD® ELEMENTS** – Available with Optional Goldenrod® Elements - All DVE/DHE models are available with the Goldenrod® 24K gold plated elements (patent pending). Goldenrod® Elements provide long-life and five times the scaling resistance of standard incoloy elements. Goldenrod® Elements carry a three-year warranty against failure due to scale buildup.

■ **SPECIAL CONSTRUCTION** – Silicon Bronze Vessels are available for special applications or very corrosive water conditions. Consult factory for specific sizes.

■ **STAINLESS STEEL VESSELS** – Are available for deionized water. Built with stainless steel under rules of Section IV of the ASME Boiler and Pressure Vessel Code for operation on deionized water having a minimum specific resistivity of 10 megohm/cm.

■ **150 OR 160 PSI WORKING PRESSURE** – Must be specified at time of order.

Other Optional Features

■ **TEMPERATURE AND PRESSURE RELIEF VALVES** – For working pressures other than standard; consult factory.

■ **HORIZONTAL OR VERTICAL** – See specifications, most gallon capacities may be obtained in vertical or horizontal construction.

■ **CIRCULATING PUMP PACKAGE** – Circulating pump and piping sized to turn over entire storage capacity of tank once each hour. Recommended to optimize available water at temperature in horizontal tanks particularly where low draw conditions are anticipated.

■ **OPTIONAL INTERNATIONAL VOLTAGES** – 380 and 415 volts three-phase.

■ **3-1/2” DIAL-TYPE PRESSURE GAUGE** – Factory-installed.

■ **3-1/2” DIAL-TYPE TEMPERATURE GAUGE** – Factory-installed.

■ **11” x 15” MANHOLE** – Available as option on tanks 700 gallons or smaller.

Control Options

■ **COPPER TUBE TANK HEATER** – Double wall copper tube tank heaters are designed for heating potable water with both potable or non-potable liquids or steam, and are specifically engineered for installation in models DVE and DHE for dual-energy applications. Tank heaters have a positive fail-safe means of leak detection in the event of either tube failure to prevent mixture of heating medium and potable water. Singlewall heat exchangers are also available.

■ **TERMINAL BLOCKS** – Allows for remote connection to building demand limiter or other functions.

■ **AUTOMATIC RESET HIGH LIMIT** – A control that in the event of high temperature, interrupts power, de-energizing elements, automatic reset. (Standard with modulating step control).

■ **INDICATING LIGHTS** – Denotes heating stage(s) in operation. Up to one light per contactor is available.

■ **OVERRIDE SWITCHES** – A simple means of load control allows all or part of unit input to be controlled manually. Up to one switch per contactor is available.

■ **SAFETY DOOR INTERLOCK** – Prevents opening of control panel door when heater power supply is on. NOTE: Once door is opened heater may be energized if necessary for service diagnosis.

■ **SHUNT TRIP CIRCUIT BREAKER** – A safety device (circuit breaker) which disconnects power to heater in the event of over-current, high temperature or low water level, breaker must be manually reset.

■ **CIRCUIT BREAKER** – A safety device which disconnects power to the heater in the event of overcurrent.

All dimensions in inches

VERTICAL ELECTRIC STORAGE HEATERS					
MODEL NO.	GAL. CAP.	MAX KW INPUT	HEIGHT	WIDTH	DEPTH
DVE-140	125	120	83-1/2	30	37
DVE-150	150	150	83-1/2	30	37
DVE-150L	150	150	59-1/2	36	43
DVE-200	200	180	79-1/2	36	43
DVE-250	250	240	93	36	43
DVE-300	300	300	83-1/2	42	49
DVE-350	350	330	95-1/2	42	49
DVE-400	400	390	102-1/2	42	49
DVE-500	500	480	97	48	55
DVE-600	600	600	112	48	55
DVE-700	700	690	124	48	55
DVE-800	800	780	116	54	61
DVE-1000	1000	990	116	60	67
DVE-1250	1250	1200	143	60	67
DVE-1500	1500	1500	155	60	67
DVE-2000	2000	1980	183	66	73
DVE-3000	3000	3000	217	72	79
DVE-5000	5000	3000	309	78	85
DVE-7500	7500	3000	330	90	97
DVE-10,000	10,000	3000	358	102	109

*Complete model number includes the desired kW at the end, e.g. DVE-300-150.
Minimum installation clearances required: 30" from front, 12" from top and 24" from right side.

All dimensions in inches

HORIZONTAL ELECTRIC STORAGE HEATERS					
MODEL NO.	GAL. CAP.	MAX KW INPUT	HEIGHT	WIDTH	DEPTH
DHE-200	200	180	38-1/2	77	36
DHE-250	250	240	38-1/2	91	36
DHE-300	300	300	44-1/2	81	42
DHE-350	350	330	44-1/2	93	42
DHE-400	400	390	44-1/2	100	42
DHE-500	500	480	51	94	48
DHE-600	600	600	51	109	48
DHE-700	700	690	51	121	48
DHE-800	800	780	57	111	54
DHE-1000	1000	990	61	111	60
DHE-1250	1250	1200	61	138	60
DHE-1500	1500	1500	61	150	60
DHE-2000	2000	1980	70	177	66
DHE-3000	3000	3000	76	211	72
DHE-5000	5000	3000	82	296	78
DHE-7500	7500	3000	94	317	90
DHE-10,000	10,000	3000	106	345	102

*Complete model number includes the desired kW at the end, e.g. DVE-300-150.
Minimum installation clearances required: 30" from front, 12" from top and 24" from right side.

Automatic Circulating Water Heaters



The A. O. Smith high efficiency condensing XP Water Heater utilizes a state-of-the-art heat exchanger and control technology to provide large volumes of hot water for demanding commercial and industrial potable hot water applications. The all stainless steel water tube heat exchanger construction allows the XP Water Heater to operate in a continuous condensing mode while maximizing longevity and delivering thermal efficiencies as high as 99% when operating in low temperature applications.

A unique multi-burner design is control sequenced and modulated to produce turndown rates of up to 20:1. Precise temperature control and accurate load matching produce smooth system operation and eliminates wasteful short cycling and temperature overshooting.

Advanced Multi-Burner, Low NOx Combustion Technology

- Venturi-mixing gas / air ratio system - works with variable speed blower to precisely mix gas and air throughout firing range
- Fully modulating capability prevents energy-stealing short cycling and provides smooth system operation with higher overall system efficiencies

Available in Natural gas and Propane (LP)

Low NOx Operation

- Complies with SCAQMD Rule 1146.2 for XWH1000 through XWH2000 and Rule 1146.1 for XWH2600 and XWH3400, and other air quality management districts with similar requirements for low NOx emissions

Advanced Solo Control

- Large touch screen user interface
- Factory standard with MODBUS protocol connections
- The latest in energy saving algorithms
- Includes remote tank temperature control to adjust tank temperature at the water heater - modulates the water heater to maintain tank set point temperature within +/-1 degree
- Water heater output control features 20:1 turndown ratio on models 2 million btuh and up, 10:1 turndown ratio on models 1.7 million btuh and down

All-Bronze Factory-Mounted Pump(s)

- Integrally mounted, wired, and controlled by the water heater control
- Factory-sized for proper flow between water heater and storage tank
- Allows 50 equivalent feet of piping between water heater and tank

Multi-Pass/Multi-Burner Condensing Stainless Steel Heat Exchanger

- Utilizes leading-edge multi-pass water tube heat exchanger to maximize heat transfer
- Designed for fully condensing operation throughout the heating range
- All heating surfaces are 316L stainless steel to provide a long and trouble-free service life
- Saves both fuel and operating cost with every heating cycle
- Impervious to thermal shock

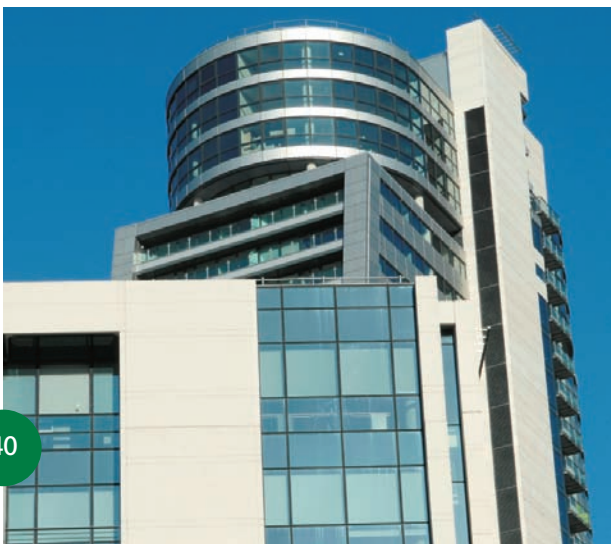

XWH Gas Circulating Water Heaters

A unique multi-burner design

Direct Vent Flexibility

- Direct vent up to 100 equivalent feet of pipe
- Sidewall or vertical
- Lower installation cost with approved CPVC / PVC venting material – uses CPVC for first 10 feet and PVC thereafter
- Approved for use with UL approved AL29-4C® stainless steel venting materials

Factory Start-Up Included

- Required for activating warranty and assuring maximum operating performance. Contact your local sales representative or Authorized Start-Up Agent to arrange a FREE certified start-up.

Meets the Thermal Efficiency Requirements of the U.S. Department of Energy and Current Edition ASHRAE/IESNA 90.1

Up to 96% Thermal Efficiency (AHRI Certified)

5-Year Heat Exchanger Warranty

- For complete information, consult written warranty or contact A. O. Smith



Other XP Features:

- CSA certified to the ANSI Z21.10.3- CSA 4.3 water heater standard
- Honeywell sola control with color touch screen LCD display
 - Inlet / outlet and remote tank temperature display
 - Onboard Modbus communications
 - Logs faults, run time, cycles
 - Redundant flow and low water protection - factory installed LWCO and flow switch(s)
 - Multi-burner sequencing models 2 million btuh and up have 4 burners; models 1.7 million btuh and down have 2 burners
 - Redundant ignition controls – should one burner fail remaining burners continue to heat
 - Alarm buzzer
- Remote tank temperature sensor included
- 20:1 turndown ratio on models 2 million btuh and up, 10:1 turndown ratio on models 1.7 million btuh and down
- Horizontal and vertical direct and sidewall vent options up to 100 equivalent feet of piping
- Approved for CPVC / PVC plastic vent materials
- Meets ASME CSD-1 / GE gap codes – factory standard
- Direct spark ignition
- Factory-installed electrical disconnect
- All bronze factory-mounted pump(s)
- 316L stainless steel heat exchanger
- ASME 160# working pressure
- ASME rated pressure relief valve – 125 PSI

XP Options:

- ASME HLW stamped heat exchanger(s)
- Condensate neutralization kit
- Vent termination kits
- Skid mounted systems

RECOVERY CAPACITIES										
MODELS	INPUT RATING (BTU/HR)	WATER FLOW	TEMPERATURE RISE - °F (°C)							
			40	60	70	80	90	100	120	140
			(22)	(33)	(39)	(44)	(50)	(56)	(67)	(78)
XWH-1000	920,000	GPH	2,662	1,775	1,521	1,331	1,183	1,065	887	761
		LPH	10,078	6,719	5,759	5,039	4,479	4,031	3,359	2,880
XWH-1300	1,300,000	GPH	3,742	2,495	2,139	1,871	1,663	1,497	1,247	1,069
		LPH	14,167	9,444	8,095	7,083	6,296	5,667	4,722	4,048
XWH-1700	1,700,000	GPH	4,904	3,269	2,802	2,452	2,180	1,962	1,635	1,401
		LPH	18,565	12,376	10,608	9,282	8,251	7,426	6,188	5,304
XWH-2000	1,999,900	GPH	5,794	3,862	3,311	2,897	2,575	2,317	1,931	1,655
		LPH	21,931	14,621	12,532	10,966	9,747	8,773	7,310	6,266
XWH-2600	2,600,000	GPH	7,501	5,000	4,286	3,750	3,334	3,000	2,500	2,143
		LPH	28,393	18,929	16,225	14,196	12,619	11,357	9,464	8,112
XWH-3400	3,400,000	GPH	9,891	6,594	5,652	4,945	4,396	3,956	3,297	2,826
		LPH	37,441	24,961	21,395	18,721	16,641	14,976	12,480	10,697

Automatic Circulating Water Heaters



SINGLE HEAT EXCHANGER MODELS

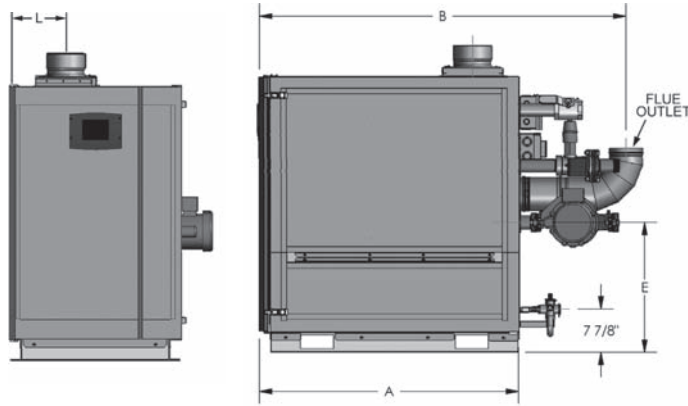

SINGLE HEAT EXCHANGER MODELS
Rough In Dimensions (Single)

Models	XWH-1000		XWH-1300		XWH-1700	
Dimensions	Inches	mm	Inches	mm	Inches	mm
Flue Outlet Diameter	6	152	8	152	8	203
Air Intake Diameter	6	152	6	152	8	203
Water Inlet	2 inch NPT		2 inch NPT		2 1/2 inch NPT	
Water Outlet	2 inch NPT		2 inch NPT		2 1/2 inch NPT	
Gas Inlet	2 inch NPT		2 inch NPT		2 inch NPT	
A	47	1199	49	1245	57	1448
B	67	1702	68	1727	76	1930
C	29	737	29	737	29	737
D	37	940	38	965	37	940
E	23	584	23	584	24	610
F	9	229	9	229	9	229
G	34	864	34	864	34	864
H	44	1118	45	1143	45	1143
J	6	152	6	152	6	152
K	11	279	11	279	11	279
L	12	305	11	279	12	305

DOUBLE HEAT EXCHANGER MODELS
Rough In Dimensions (Double)

Models	XWH-2000		XWH-2600		XWH-3400	
Dimensions	Inches	mm	Inches	mm	Inches	mm
Flue Outlet Diameter	8	203	8	203	10	254
Air Intake Diameter	8	203	8	203	10	254
Water Inlet	3 inch NPT		3 inch NPT		4 inch NPT	
Water Outlet	3 inch NPT		3 inch NPT		4 inch NPT	
Gas Inlet	2 inch NPT		2 inch NPT		3 inch NPT	
A	47	1194	49	1245	57	1448
B	78	1981	80	2032	91	2311
C	36	914	37	940	37	940
D	22	559	22	559	22	559
E	40	1016	41	1041	41	1041
F	7	178	6	152	6	152
G	10	254	10	254	10	254
H	4	102	4	102	4	102
J	20	508	19	483	19	483
K	12	305	12	305	13	330

DOUBLE HEAT EXCHANGER MODELS

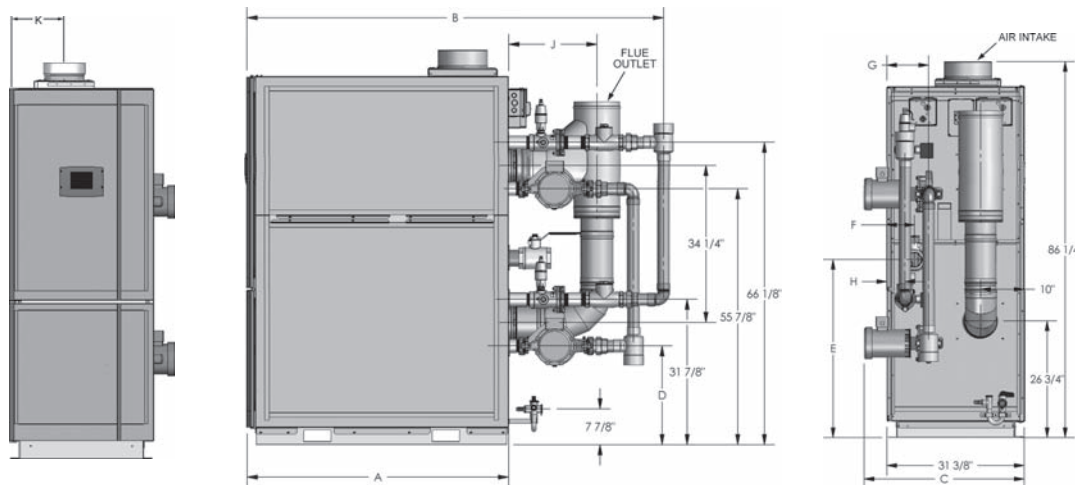

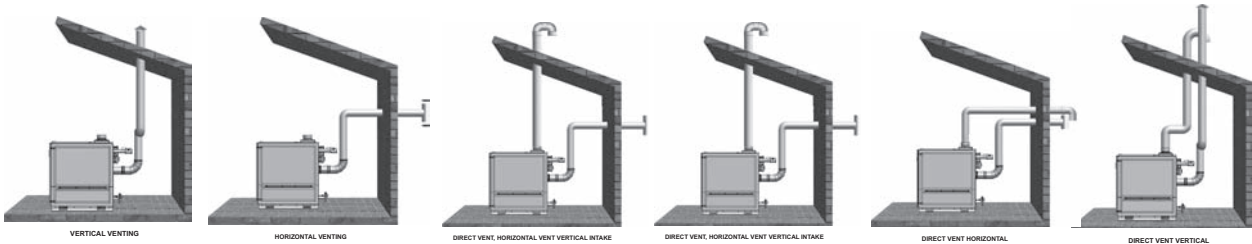

VERSATILE MULTI-VENTING CONFIGURATIONS



Direct or sidewall vent for up to 100 equivalent feet of pipe. Lower installation cost with approved CPVC/PVC venting material – uses CPVC for first 10 feet and PVC thereafter. Also approved for use with UL approved AL 29-4C stainless steel venting materials. For the detailed venting instructions review the XP water heater instruction manual at www.hotwater.com.

APPROVED VENT AND AIR INTAKE FITTINGS

EXHAUST/VENT TERMINATIONS (PVC) PART #s			
Models	Pipe Size	Vertical (PVC Rain Cap)	Horizontal (PVC Tee w/Screens)
XWH 1000	6"		
XWH 1300	8"		
XWH 1700			
XWH 2000			
XWH 2600			
XWH 3400	10"	320884-002	321765-002

AIR INTAKE TERMINATION (PVC) PART #s		
Models	Pipe Size	Combustion Air Intake (Elbow)
XWH 1000	6"	321764-000
XWH 1300		
XWH 1700		
XWH 2000	8"	321764-001
XWH 2600		
XWH 3400	10"	321764-002

Please note: When direct or sidewall venting, the water heater's CSA certification requires that only the above approved vent and combustion air intake terminations be used.

GAS PRESSURE REQUIREMENTS

MODELS (XWH)	TYPE OF GAS	MAXIMUM SUPPLY PRESSURE		MINIMUM SUPPLY PRESSURE	
		INCHES W. C.	kPa	INCHES W. C.	kPa
1000, 1300, 1700, 2000, 2500, 3400	Natural	14.0	3.49	4.0	1.0
	Propane	14.0	3.49	4.0	1.0

ELECTRICAL REQUIREMENTS

MODEL	SUPPLY VOLTAGE (VOLTS)	FREQUENCY (HZ)	CURRENT (AMPS)	ELECTRICAL NOTES:
XWH-1000	120V	60	30	A dedicated, single phase, 30/60 amp circuit breaker with a grounded neutral should be provided to supply power to the water heater.
XWH-1300	120V	60	30	
XWH-1700	120V	60	30	
XWH-2000	120V	60	60	A dedicated, single phase, 60/60 amp circuit breaker with a grounded neutral should be provided to supply power to the water heater.
XWH-2600	120V	60	60	
XWH-3400	120V	60	60	

FLOW RATE

RECOMMENDED FLOW RATES @ 0-12 GRAINS PER GALLON			
MODELS	TEMPERATURE RISE (ΔT °F)	GPM	PRESSURE LOSS IN FEET OF HEAD (P)
XWH 1000	25	70	17.5
XWH 1300	25	99	22
XWH 1700	25	129	23
XWH 2000	25	153	17.5
XWH 2600	25	198	22
XWH 3400	25	261	23

Notes: For hard water systems with water hardness greater than 12 grains per gallon, A. O. Smith recommends a water softener be installed and maintained.

The factory installed/supplied pump is sized to maintain a ΔT of 25°F through the water heater at 100% fire. In addition to the pressure loss through the water heater, the factory supplied pump is sized for an additional 50 feet of equivalent feet of piping between the water heater and a storage tank. Consult the factory for systems where the piping between the water heater and the tank exceed 50 equivalent feet.

Variable Fire (VF™) High Efficiency Circulating Water Heaters

Up to 87% Thermal Efficiency



The Art of Flexibility

The VF™ Circulating Water Heater delivers an exceptionally high thermal efficiency by combining an advanced modulating venturi-mixing gas/air ratio system with a vertical multi-pass copper heat exchanger for outstanding efficiency of up to 87% and low NOx emissions that meet the most stringent standards.

The VF™ Water Heater is capable of firing from 100% to 25% or a 4:1 turn-down ratio of rated input based on the current system demand. The VF's modulating capability is virtually limitless, and the boiler's output is based strictly on the current system demand and the required BTU's needed to maintain the desired system set point temperature.

Category IV Listed

Professional Start-Up Service Furnished

Thermal Efficiency

- Meets the thermal efficiency and standby loss requirements of the U.S. Department of Energy and current edition of ASHRAE/IESNA 90.1

Low NOx Operation

- Complies with SCAQMD Rule 1146.2 and other Air Quality Management districts with similar requirements for low NOx emissions

Other VF™ Features:

- ASME Pressure Relief Valve 125#
- Contacts for 0-10 VDC BMS External Control
- Contacts for Alarm or Any Failure
- Factory-Mounted Flow Switch
- Low Gas Pressure Switch
- All Bronze Factory Sized Pump Included (Shipped Loose)
- Digital Inlet/Outlet Temperature Read Out
- Manual Reset Hi-Limit

VF™ Options:

- Sequence Panel – Can manage 1 to 4 modulating units (Includes remote Tank sensor and sensor well)
- Alarm Bell
- Low Water Cutoff w/Manual Reset and Test
- LP Gas
- Vent Kits:
 - Horizontal Exhaust Cap
 - Horizontal Air Intake Cap
 - Horizontal Direct Vent Kit
 - Category IV to Category II Conversion Kit

Warranty:

- 5-Year Limited Heat Exchanger Warranty

Hot Water Applications:

With 5 models to choose from and BTU inputs from 500,000 BTUHs to 2 million BTUH there is a VF Water Heater or a combination of VF's that is ideal for almost any large water heating application.

MODEL NUMBER	BTU/HR NATURAL GAS INPUT	BTU/HR NATURAL GAS OUTPUT	RECOVERY 100°F RISE GPH	VENT SIZE (INCHES)	AIR INTAKE SIZE	LOAD FACTOR	APPROX. SHIPPING WEIGHT (LBS)
VWH-500N	500,000	425,000	573	4"	5"	2.78	573
VWH-750N	750,000	637,500	622	5"	5"	2.78	622
VWH-1000N	999,999	849,999	671	6"	6"	2.78	671
VWH-1500N	1,500,000	1,275,000	1,117	6"	6"	2.78	1,117
VWH-2000N	2,000,000	1,700,000	1,186	8"	8"	2.78	1,186

The Anatomy of Great Performance

A

Combustion air intake—self adjusting—no air shutter required

B

Modulating Control with 4:1 turndown ratio. The VF's output is based strictly on the current system demand and the required BTUs needed to maintain the desired system set point temperature. The VF's modulating capability is virtually limitless between 25% and 100% fire.

C

Advanced pre-mix burner design precisely mixes air and gas prior to ignition for optimum performance, with low-NOx emissions (complies with SCAQMD Rule 1146.2)

D

Venturi-mixing gas/air ratio system works with variable speed blower to precisely mix gas and air throughout firing range, provides good operation with supply gas pressures down to 4" WC, and is self-adjusting for altitudes up to 6,000 feet, all while providing low NOx emissions that meet or exceed the most stringent standards

E

Heavy-duty ASME 160 psi copper finned tube heat exchanger—vertical, straight tube, multi-pass design surrounds the burner with a 360° wall of copper finned tubing, making the entire heat exchanger resistant to thermal shock

F

The sealed heat exchanger flue collection system is constructed of stainless steel that resists corrosive flue gases

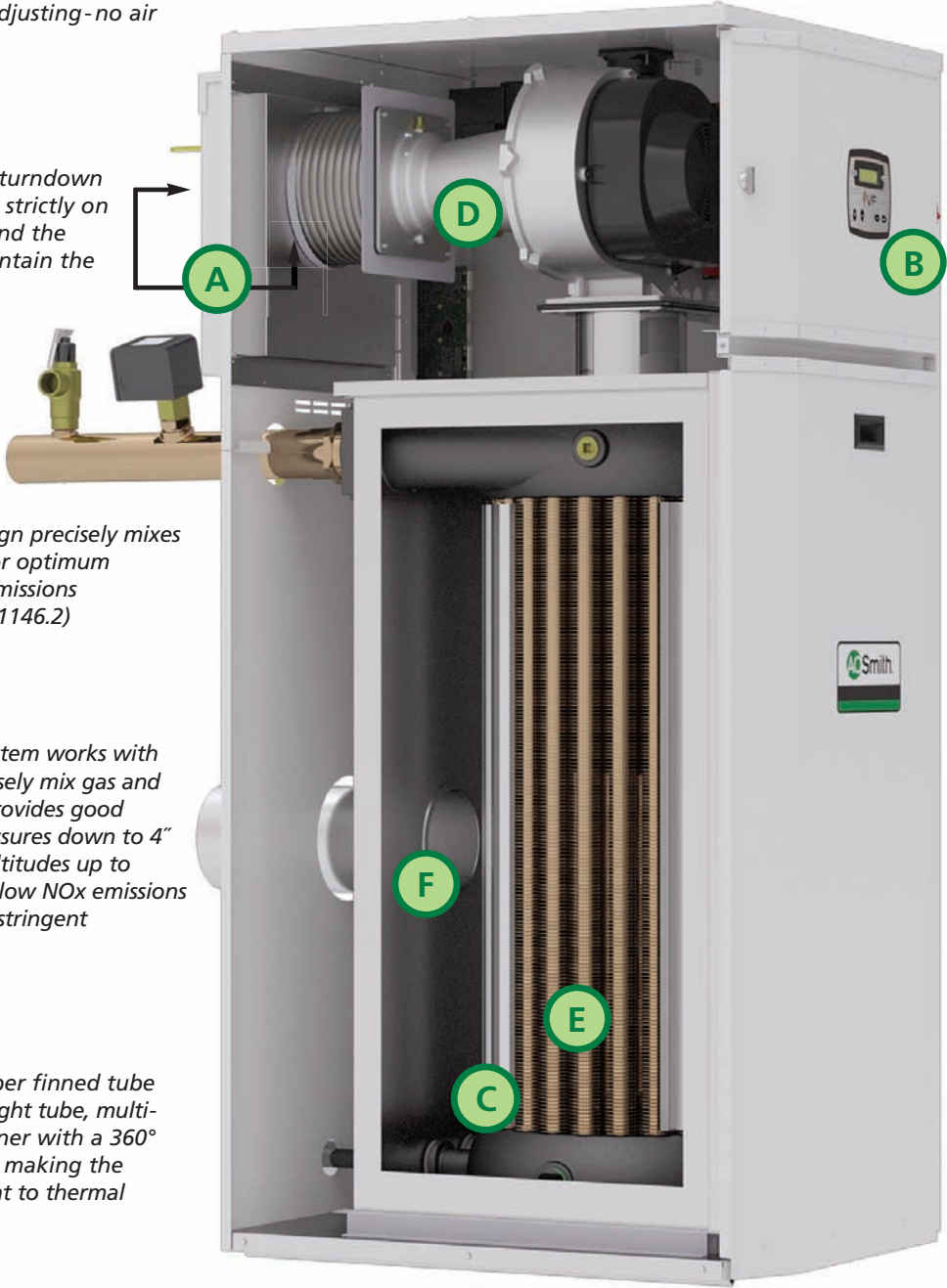

Variable Fire (VF™) High Efficiency Water Heaters

Venting Solutions

■ All VF models feature flexible direct vent and sidewall Category IV venting. In addition, the VF units may be installed as Category II appliances, allowing multiple units to be manifolded together into a common vent stack – giving you even more design options! (Both Category II and IV venting systems require corrosion-resistant, AL29-4C stainless steel sealed venting material.)

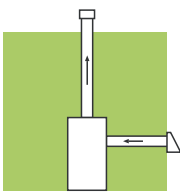

Ducted Air Vertical*

Vertical venting up to 50 equivalent feet. Draws combustion air up to 50 feet from a different pressure zone using Category IV vent materials.

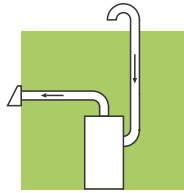

Ducted Air Horizontal*

Vents horizontally up to 50 equivalent feet and draws combustion air up to 50 feet from a different pressure zone using Category IV vent materials.

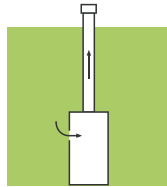

Vertical Venting

Using Category IV vent materials

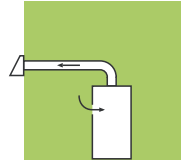

Sidewall Venting*

Horizontal venting up to 50 equivalent feet using Category IV vent materials.

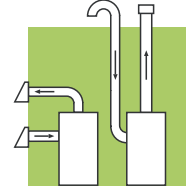

Direct Venting*

Horizontal or vertical venting up to 50 equivalent feet. Draws combustion air up to 50 feet from the same pressure zone using Category IV vent materials.

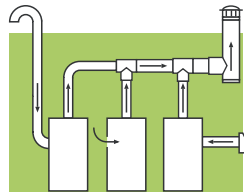

Common Venting*

Vents multiple units horizontally through one vent termination and draws combustion air from the room, roof or sidewall. Category IV to II conversion kit required.

*Requires optional factory-supplied vent and combustion air intakes terminals be used.

Note: For the most current VF venting distances/information, consult the VF Instruction Manual, available through your local A. O. Smith representative, or online at www.hotwater.com

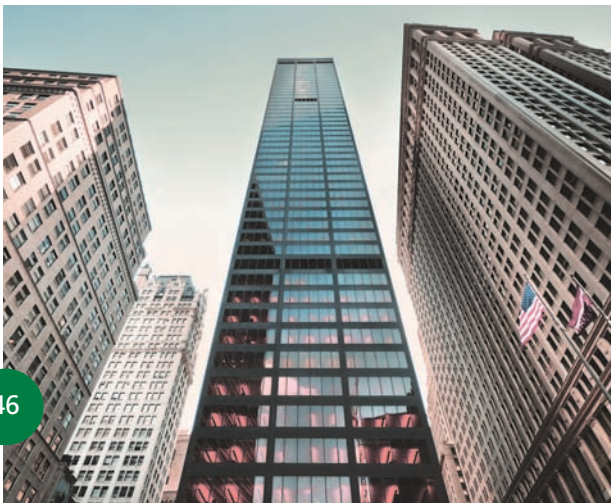

Variable Fire (VF™) Water Heaters



Ac-U-Temp —A total hot water supply system using VF Series Water Heaters

With Ac-U-Temp, A. O. Smith makes it as easy as possible to install a complete packaged hot water supply system, combining 88% efficient VF Series Water Heaters with A. O. Smith storage tanks. A. O. Smith offers a wide range of available water heater/storage tank combinations using the Ac-U-Temp system. There are a number of standard water heater and tank configurations with tanks up to 1,000 gallons, or we can custom design and build an Ac-U-Temp system with tanks up to 10,000 gallons to meet your specifications and application requirements. Ac-U-Temp systems are shipped fully assembled, pre-piped and pre-wired. All the installer has to do is make the flue, gas, electrical and water connections, so field errors are minimized.

Consult your A. O. Smith representative for more information on the wide range of available water heater/storage tank combinations using the Ac-U-Temp system.

For complete specifications on the VF Series, consult the specification sheets at www.hotwater.com or contact your local A. O. Smith sales representative.

Burkay® Genesis® Circulating Water Heaters

9 Models 400,000 BTUs to 2.07
Million BTUs, up to 85% Efficient

Burkay
GENESIS®



84% THERMAL EFFICIENCY – The absolute highest thermal efficiency possible by a non-condensing water heater is achieved by the Genesis.

Low NOx –Precise amounts of gas and air are premixed through special orifices and forced through stainless steel burners that provide a complete and clean combustion. GW/GWO 1000 through 1850 comply with SCAQMD Rule 1146.2 and other Air Quality Management with similar requirements. GW/GWO 2100 and 2500 comply with SCAQMD Rule 1146.1 when field certified by SCAQMD.

Electronic Control with Precise Temperature Management

- Controls every electrical water heater function, including pump operation and main burner ignition, delivers precise temperature management, with $\pm 1^\circ$ accuracy
- Display panel shows current operating status and fault readings
- Display also shows temperature setpoints, outlet temperature, current inlet/outlet differential and tank temperature
- Included remote temperature sensor when mounted in the storage tank allows the tank temperature to be set and monitored at the water heater

Stage Gas Firing System

- Prevents short cycling and ensures smooth operation, saves fuel and extends product life
- Delivers maximum output when demand is high, reduced firing rates during off peak times.

Ultra-Low-NOx Operation

- Complies with SCAQMD Rule 1146.2 and other Air Quality Management Districts with similar NOx emission requires of 14 ng/J or 20 ppm (GW/GWO 1000-1850 models)

Copper Finned-Tube Heat Exchanger

- Gasketless glasslined headers and copper-finned tubes with extruded integral fins deliver exceptional heat transfer
- Copper is lightweight for easier handling and immune to thermal shock

Space-Saving Design

- Optional stack rack allows one unit to be stacked on top of another, doubling output within the footprint of a single unit
- If floor space is limited, the Genesis water heater can be installed outdoors with an optional outdoor Vent Cap.

Meets ASHRAE/IESNA 90.1-2004

Multiple Venting Options

- All Genesis models can vent vertically in Category I with double wall "B" vent or horizontally in Category IV with AL29-4C stainless steel vent material.

Factory Start-Up Included

- Required for activating warranty and assuring maximum operating performance. Contact your local sales representative or Authorized Start-Up Agent to arrange a FREE Certified Start-Up.

Five-Year Heat Exchanger Limited Warranty

- For complete information, consult written warranty

Burkay® Genesis® Circulating Water Heaters



Genesis® Model GWH2100 (2.07 million BTUs) shown



A. O. Smith Engineering Delivers Everything You Want in a Non-Condensing Low NOx Water Heater

Electronic Control provides remote tank temperature sensing and +/- 1° tank temperature control. Controls the factory furnished pump to assure maximum heat transfer and reduce stand-by heat loss.

Ceramic Fiber Combustion Chamber
Rated for temperatures up to 2300°F

Copper Finned Tube Heat Exchanger

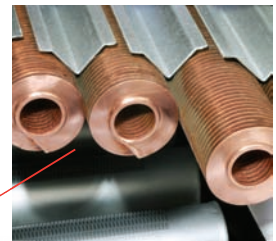

- Copper-finned design delivers superior heat transfer and energy efficiency
- Copper is lightweight, immune to rust and thermal shock

Unique **gasketless glasslined header** design eliminates gaskets and O-rings.

Combustion Air Blower with Air Shutter
Adjusts to the application for maximum efficiency.

Multi-Stage Firing

Hot Surface Ignition

Pressurized Combustion System
Clean burning Stainless Steel Premix Burners for smooth ignition, clean combustion and low NOx that meets or exceeds the most current NOx requirements

Burkay® Genesis® Circulating Water Heaters

84% Thermal Efficiency

MODEL NUMBER	INPUT MBH	OUTPUT MBH	RECOVERY GPH AT DEGREE RISE			DIMENSIONS IN INCHES			VENT/INTAKE CONNECTIONS	LOAD FACTOR	APPROX. SHIPPING WEIGHT (LBS)
			40°F	100°F	140°F	HEIGHT	WIDTH	DEPTH			
GWH-400N	399	339	1,028	412	294	31-1/2	37-3/4	22-1/4	6"	1.01	454
GWH-500N	500	425	1,288	515	368	31-1/2	45-1/2	22-1/4	6"	1.19	467
GWH-650N	650	553	1,674	670	478	31-1/2	56-3/4	22-1/4	8"	1.58	551
GWH-750N	750	638	1,932	773	552	31-1/2	64	22-1/4	8"	1.58	611
GWH-1000N	990	842	2,550	1,020	729	36	48-1/4	33-3/4	10"	3.33	843
GWH-1250N	1,260	1,071	3,245	1,298	927	36	58-1/2	33-3/4	12"	3.33	939
GWH-1450N	1,440	1,224	3,709	1,484	1,060	36	68-3/4	33-3/4	12"	3.33	1,035
GWH-1800N	1,800	1,530	4,636	1,855	1,325	36	82-1/4	33-3/4	12"/14"	5	1,168
GWH-2100N	2,070	1,760	5,332	2,133	1,523	36	92-1/2	33-3/4	12"/14"	5	1,285



Standard Vent or Direct Vent Versatility!

- Genesis® boilers provide multiple options for exhaust venting and standard indoor atmospheric or direct-from-outdoors (direct vent) intake of combustion air. Sidewall vent and intake runs can save substantially on installation costs where vertical runs are not practical. Direct vent operation utilizes a 2-pipe system that allows clean, uncontaminated outside air to be pulled directly into the unit, and is an ideal choice when negative indoor air pressure is a concern.

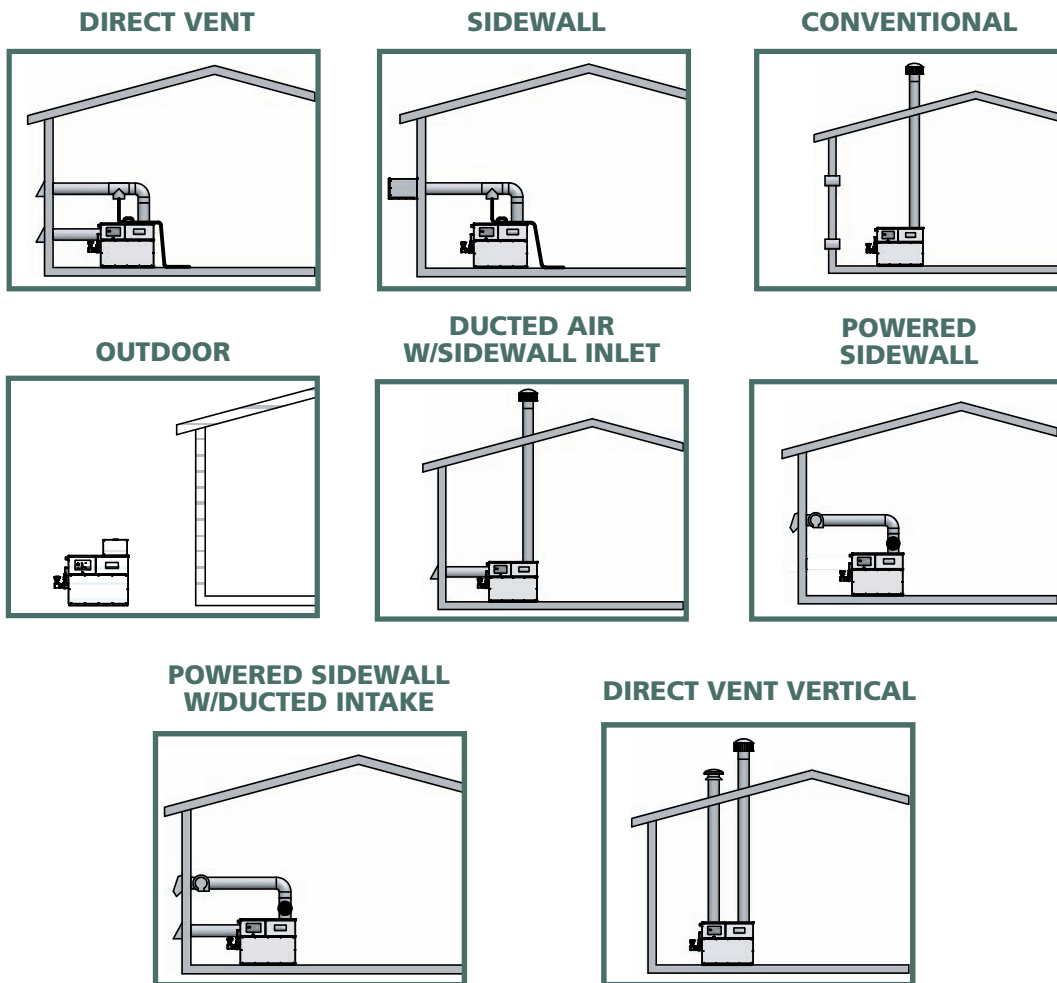

Multiple Venting Options

- The Genesis models offer eight venting options to meet the most challenging installation requirements. The Genesis can vent vertically in Category I with double wall “B” vent or horizontally in Category IV with AL29-4C stainless steel vent material. Vent termination can be Rooftop or Sidewall with combustion air drawn naturally from the equipment room or via dedicated air intake piping. And if floor space is limited, the Genesis water heater can be installed outdoors with an optional Outdoor Vent Cap.

Note: For the most current Genesis venting distances/information, consult the Genesis Product Manual, available through your local A. O. Smith representative, or online at www.hotwater.com.

Burkay® HW Gas Models

Up To 82% Thermal Efficiency
Circulating Water Heaters and Hydronic
Heating Boilers

Famous Burkay® reliability. Because of their lightweight and compact design, they may be easily transported on a two-wheel dolly replacing large boilers in a much smaller space. Burkay® models are for indoor use in installations requiring higher inputs...up to 670,000 BTU. They can be manifolded for unlimited fire power.

100% All Non-Ferrous Waterways

- All waterways 100% copper, brass or bronze... resists thermal shock and corrosion buildup

Low Profile Diverter

- Special design allows maximum installation flexibility

Copper Wall Combustion Chamber

- Coils of tightly wound copper tubing form a unique and highly efficient combustion chamber
- Optimum energy transfer achieved with integral extruded fin copper-finned tubes

Meets the thermal efficiency and standby loss requirements of the U.S. Department of Energy and current edition of ASHRAE/IESNA90.1

5-Year Heat Exchanger Limited Warranty
(Domestic hot water supply)

10-Year Heat Exchanger Limited Warranty
(Hydronic heating applications - 300-670 models only)

All dimensions in inches

HW BURKAY MODELS										
MODEL NO.	INPUT BTU/HOUR	OUTPUT BTU/HOUR	TEMP RISE °F-GPH			VENT DIA.	HT.	DIA.	DPT	SHIP WEIGHT
			40	100	140					
HW-120M	120,000	99,840	300	120	86	6	49-3/8	20-3/4	26-11/16	120
HW-160M	160,000	128,320	385	154	110	7	50-1/8	20-3/4	26-11/16	154
HW-200M	199,000	162,185	487	195	139	7	53-1/4	20-3/4	26-11/16	165
HW-225M	225,000*	180,900	543	217	155	7	60	20-3/4	26-11/16	175
HW-300	300,000	247,200	742	297	212	8	65	25-1/4	29-5/8	240
HW-399	399,000	322,790	969	388	277	10	57-1/8	27	31-1/2	291
HW-420	420,000	344,400	1034	413	295	10	57-1/8	27	31-1/2	291
HW-520	520,000	429,000	1288	515	368	10	68-5/16	27	36-1/2	361
HW-670	660,000	543,800	1632	656	466	12	67	27	38-1/4	361

*Available in natural gas only



Ac-U-Temp Complete Hot Water Supply Systems

Built to order...factory-engineered and pre-assembled...easier to install



We've taken our best automatic circulating water heaters and tanks and made them available in a total system called Ac-U-Temp. Completely pre-piped and pre-wired, built to your specifications and skid-mounted, Ac-U-Temp systems streamline installation and reduce labor costs. Once on-site, the installer simply connects the flue, gas, electric supply, cold water make-up and hot water supply.

Tank Capacities

- Standard tank sizes from 80 to 1,000 gallons
- Custom tanks to 10,000 gallons

Eliminates Costly Field Errors

- Factory-engineered and assembled to assure proper pipe, pump and wired sizing
- Systems are pre-piped and wired to guarantee maximum system efficiency

Simplifies Installation

- Installer simply connects the flue, gas, electric supply, cold water make-up and hot water supply

Ac-U-Temp Storage Tanks

- Each tank is specially designed with tank opening locations that provide maximum tank draw efficiency and eliminate any unnecessary piping and connections
- Standard Ac-U-Tanks are factory jacketed and insulated (Bare tanks are also available)

Custom Ac-U-Temp Systems

- All systems are built to order to meet your specifications
- Many heater and tank combinations available

Multi-Tank Systems

- For applications with low ceiling heights or unique installation challenges

Electric Back-Up

- Heavy-duty electric elements and controls can be specified for up to 3,000 kW for 100% electric back-up
- Provides hot water even during natural gas curtailments

Superior I-Beam Skid

- For easy shipping
- Larger systems may be shipped on a split skid that is easily assembled during installation

Factory Hydrostatic And Fire-Tested Before Shipping

5-Year Heat Exchanger Module And 5-Year Limited Tank Warranty



Other Features

- CSA Certified and ASME rated T&P relief valve
- Tank temperature sensor
- Tank thermometer
- Isolation valves (Reliable ball valves)
- 125 PSI tank construction

Options

- All-bronze circulating pump
- Sequencing control panel for multi-heater systems
- 150 PSI tank construction
- 11" X 16" manhole for easy maintenance
- Cement and epoxy tank linings available to meet special specifications
- Optional dual energy source capability

Shown below are standard Ac-U-Temp configurations.* Custom designs are available to meet specific needs.

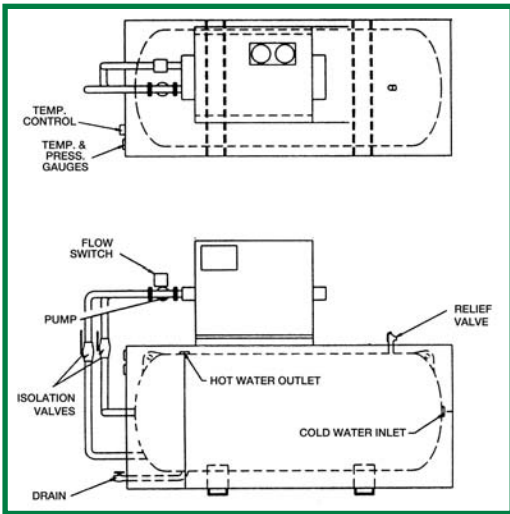

Genesis model stacked on a horizontal jacketed tank.

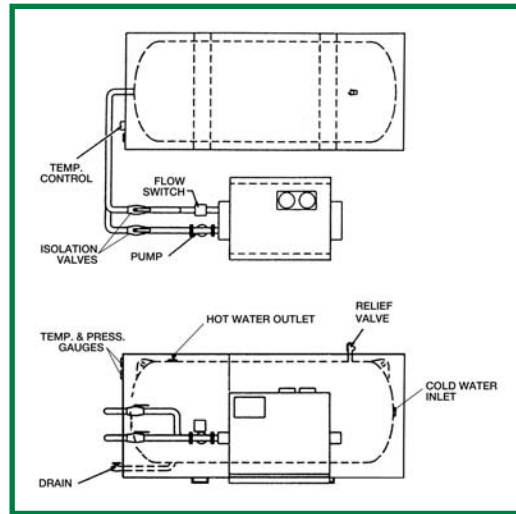

Genesis model placed in front of a horizontal jacketed tank.

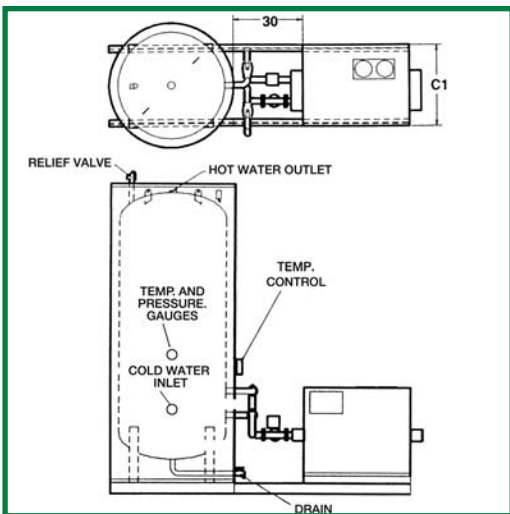

Genesis model with a vertical horizontal storage tank.

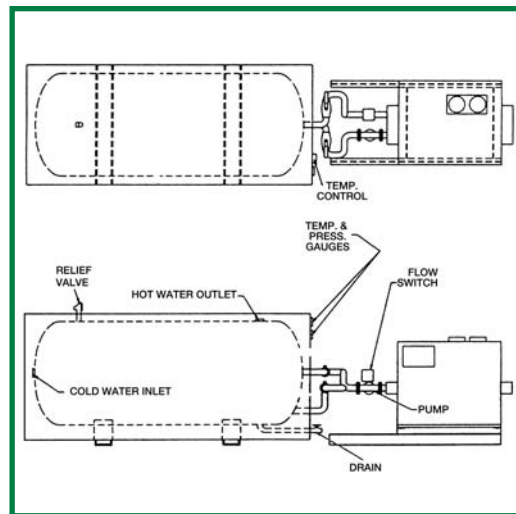

Genesis model skid mounted in line with a horizontal jacketed tank.

*The four examples shown feature the Genesis boiler with various piping configurations with a jacketed insulated tank.

Heavy-Duty Electric Dura-Power™ Hot Water NW Boiler Models

Designed for use as a hot water boiler for space heating applications



ASME



Optional Goldenrod® 24-carat gold-plated elements resist lime scale adhesion and sheath temperatures up to 1500° F.

ASME Code Construction

- All vessels manufactured to applicable ASME code
- Vessels with maximum working pressure of 160 PSI or less (standard design is for 125 PSI) at 240°F maximum temperature bear the "H" symbol

Incoloy Immersion Heaters

- Heavy-duty medium-watt density elements (3 per immersion heater)
- Incoloy sheathing provides excellent protection against oxidation and scaling
- Inputs range from 450 kW to 6,000 kW

Control And Power Circuit Fusing

- Meets National Electrical Code
- 100,000A I.C. cartridge-type fuses protect all elements and contactors

Pilot Switch And Light

- Permits manual starting and stopping of heater by interrupting power to the control circuit
- Pilot light indicates when control circuit is energized

Heavy-Duty UL-Rated Magnetic Contactors Rated For 100,000

Low Water Cutoff

- Probe type, electric low water cutoff prevent energizing of elements in the even of low water condition

120V Control Circuit

- Powered by fused transformer

Modulating Step Control

- Solid state modulating step control modulates heat input to match load

1-Year Limited Tank Warranty

All dimensions in inches

MODEL NO.	GAL. CAP.	KILO-WATTS MAXIMUM	HT.**	WIDTH	DEPTH	INLET AND OUTLET*	BOILER DRAIN
NW-37	37	180	42	32	30	3	1
NW-60	60	300	57	32	30	3	1
NW-96	96	480	69-1/2	36	38	4	1-1/4
NW-150	150	720	69-1/2	54	44	5	1-1/2
NW-220	220	1140	71	60	50	5	1-1/2
NW-334	334	1740	99	60	50	6	2
NW-400	400	2100	90-1/2	66	56	8	2
NW-500	500	2580	90-1/2	72	62	8	2
NW-670	670	3300	96-1/2	78	68	8	2

NOTE: For boilers 3400 kW to 6000 kW, consult factory.

*All fittings under 4" will be threaded type. All fittings 4" and larger will be flanged.

**Where overall height is a problem, a larger diameter vessel with a reduced height may be furnished.



Designed for utilizing steam or high temperature boiler water as an energy source

Steam or Boiler Hot Water HWG Generator Systems

These skid-mounted water heater systems are completely assembled and packaged for use. All components are sized, piped and checked at the factory before shipment. HWG systems save labor and time, requiring only connection to heat source.

Packages include pressure regulators, temperature regulators, steamtraps, strainers and other custom items such as standard or optional features.

Tank and heat exchanger capacities will closely match those now available, 80 through 12,500 gallons and 0.9 through 214 square feet of heat transfer.

Insulation

- Models are insulated with fiberglass to meet the most current ASHRAE standards

Integral Pump

- System includes an integral bronze circulator pump

Steam Units

- Standard steam trim consists of temperature control valve, inlet and auxiliary steam traps, inlet and auxiliary strainers, steam pressure gauge with siphon, vacuum breaker and air vent

Boiler Units

- Standard boiler water trim includes temperature control valve and boiler water temperature gauge

Cathodic Protection

- Standard systems employing glass, cement or epoxy-lined tanks are fitted with magnesium anodes to help prevent corrosion

Gallon Sizes

- HWG models are available from 140 gallons to 12,500 gallons in both vertical and horizontal configurations

Additional Features

- ASME Code (Section IV)
- All copper recirculation with two bronze ball valves
- Flush-mounted temperature gauges and pressure gauges
- National Board Stamped
- CSA Certified and ASME rated T&P relief valve
- Heating coil Section VIII of ASME code

5-Year Limited Tank Warranty And 1-Year Limited Coil Warranty

Options

- Storage Tanks:** 150# through 160# PSI working pressure, ASME Section VIII construction, 4" X 6" handhole, 11" X 15" manhole, cement, epoxy or galvanized linings
- Water To Water:** Pilot (spring, air, temperature) operated temperature regulator, bypass loop in boiler water line for regulator isolation
- Steam To Water:** Pilot (spring, air, temperature) operated temperature regulator, bypass loop in steam line for temperature regulator, vacuum breaker



For GPH recoveries, consult specification sheet.

Custom Semi-Instantaneous Water Heaters HWI Models

Boiler Water or Steam

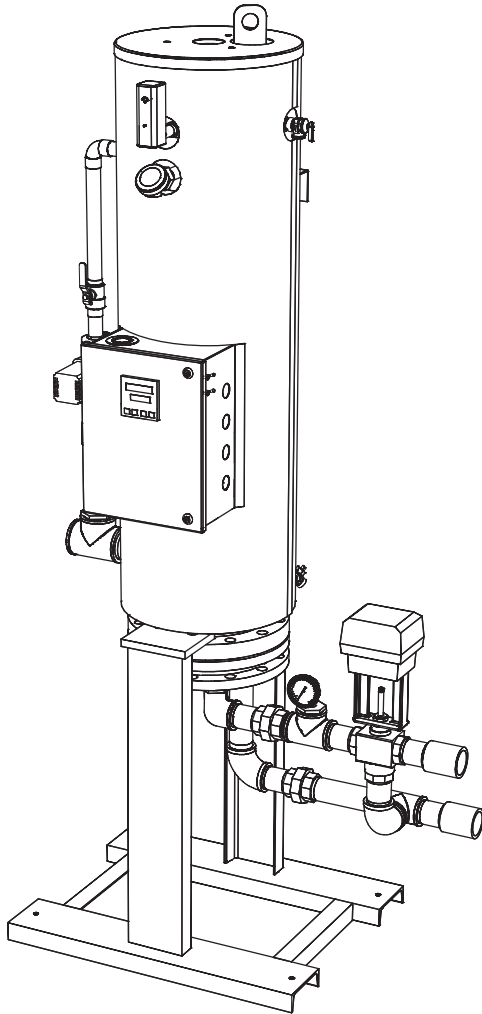

A. O. Smith's HWI models are available for operation with steam or boiler water as the energy source. They are factory assembled with components sized, piped and checked at the factory before shipment. HWI models are all space saving vertical models.

Control Features

- *Single Point Wiring*—Single 120V connection, controls including integral circulation
- *On/Off Switch*—Allows local on/off for service
- *Temperature Readout*—LED readout of water temperature
- *PID Temperature Control*—Modulates electrical control valve
- *Closes main valve if "over" temperature conditions exist*
- *Remote Temperature Signal*
- *Two-Wire RS485 Communication (MODBUS or ASCII)*

For additional information please call the factory with the following:

- *Required gallons per hour recovery needed*
- *Temperature rise needed; for example—40° to 140°*
- *Single or Double-Wall Coil*
- *If steam is the energy source, what is the steam pressure? For example—15 psi, 30 psi, etc.*
- *If boiler water is the energy source, what is the minimum boiler water temperature? For example - 180°, 140°, etc.*

Note: Orders cannot be processed until the above required information has been provided.





Custom Small and Large Volume Storage Tanks

Models (T, TL, TN ,TJ, TJV, TJH, TJVT)

These storage tanks are ideal for use with gas-fired copper heat exchanger equipment and other A. O. Smith hot water systems for storage of any potable water at temperatures of 180°F or lower. Sizes range from 80 to 12,500 gallons and custom models are available with special linings, heating coils (single-or double-wall), and accessories.

Glasslined Tank

- Internal surfaces exposed to water are glasslined per ASME, HLW procedures using an NSF approved glass-lining compound

Horizontal Or Vertical Mounting

- Except for TJ-80 (vertical only) and TL-500 (horizontal only)

Jacketed Tanks

- Tanks meet R12.5 minimum thermal insulation requirements of the U.S. Department of Energy and Current Edition of the ASHRAE/IESNA 90.1

Anodic Protection

- Magnesium anodes help extend tank life

ASME Construction

- Standard on TJV/TJH jacketed tanks; 100, 125, 150 & 160 PSI maximum working pressure available

5-Year Limited Tank Warranty

Options

- Manifold kits
- Flexible R-11 jackets for field installation
- Manholes/Handholes
- Factory-mounted temperature or pressure gauges
- Extended warranties
- Lifting lugs
- Military specifications

Other Linings Available

- Cement formulation provides excellent corrosion protection; available on 200-gallon and larger sizes
- Epoxy lining is suitable for cold or hot water storage; available on 200-gallon and larger sizes

Other Constructions

- Black steel, stainless and silicon bronze tanks are available for extreme severe or special applications; ASME is standard

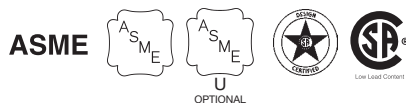

Desired temperatures in A. O. Smith custom-lined hot water storage tanks can be maintained with special copper tube heating elements. Available for use with steam or boiler water, single- or double-wall construction.



Custom Tanks Built To Order For Any Need

A. O. Smith understands the variety of special needs you may have in designing a complete commercial hot water supply system. We can meet just about any need you specify, with our "HD" High-Draw Custom Storage Tanks from 80 to 10,000 gallons, all with ASME construction, and with an extensive menu of options, including:



- Cement, epoxy or glass linings
- Black steel tanks, stainless steel tanks, silicon bronze tanks
- Military specifications
- Manholes
- Handholes
- Lifting lugs
- Steam or hot water tank heaters
- Special and additional tank openings
- Ring and leg bases
- Horizontal tank saddles
- Factory-mounted temperature or pressure gauges



All dimensions in inches

BARE (UNINSULATED) STORAGE TANKS			
MODEL NO.	GAL.	APPROX. OVER-ALL DIMENSIONS DIA. X LENGTH	WORKING PRESSURE (PSI)
T-80 STD	80	20 X 62-1/8	150
T-80 ASME	80	26-1/2 X 57-7/8	150
T-120 STD	120	24 X 65	150
T-140 ASME	140	24 X 76-1/4	125
T-200 STD	200	30 X 72	150
T-200 ASME	200	30 X 72	125
T-250 ASME	250	30 X 84	125
T-350 STD	350	36 X 87-1/2	125
T-350 ASME	350	36 X 87-1/2	125
T-400 ASME	400	36 X 97-1/8	125
TL-500 ASME	500	36 X 121-3/4	125
TN-500 ASME	500	42 X 88	125
T-500 ASME	500	48 X 73	125
T-750 ASME	750	48 X 105-7/8	125
T-1000 ASME	1000	48 X 137-3/4	125

All dimensions in inches

VERTICAL JACKETED (INSULATED) STORAGE TANKS			
MODEL NO.	GAL.	APPROX. OVER-ALL DIMENSIONS DIA. X LENGTH	WORKING PRESSURE (PSI)
TJ-80 STD	80	20 X 62-1/8	150
TJ-80 ASME	80	26-1/2 X 57-7/8	160
TJV-120 ASME	119	26 X 61-3/4	160
TJV-120 M	119	29-3/8 X 62	160
TJV-140 ASME	140	30 X 87	125
TJV-200 ASME	200	36 X 83	125
TJV-200 M	175	32 X 77	125
TJV-250 ASME	250	36 X 93	125
TJV-350 ASME	350	42 X 99	125
TJV-400 ASME	400	42 X 105	125
TJVT-500 ASME	500	48 X 100	125
TJV-500 ASME	500	54 X 84	125
TJV-750 ASME	750	54 X 116	125
TJV-1000 ASME	1000	54 X 148	125

All dimensions in inches

HORIZONTAL JACKETED (INSULATED) STORAGE TANKS			
MODEL NO.	GAL.	DIM.	PRESSURE
TJH-200 ASME	200	36 X 77	125
TJH-250 ASME	250	36 X 90	125
TJH-350 ASME	350	42 X 93	125
TJH-400 ASME	400	42 X 99	125
TJHF-500 ASME	500	40 X 94	125
TJH-500 ASME	500	54 X 79	125
TJH-750 ASME	750	54 X 110	125
TJH-1000 ASME	1000	54 X 143	125

For complete specifications on A. O. Smith Commercial Storage Tanks, consult Specification Sheets at www.hotwater.com.

The industry's largest commercial product selection.

A. O. Smith's reputation for innovation continues to soar with our most complete line of products yet. With the trademark blend of innovative technology and energy-efficient solutions, our comprehensive line is the natural source for everything from the smallest commercial installation up to the largest multi-structure complex.

We offer over 500 different commercial models, including gas fired, oil-fired and electric configurations, ranging in capacities from 5 to 10,000 gallons, with input range from 50,000 BTU to the equivalent of 2,500,000 BTU.

Through an inspired blend of innovation, efficiency and years of expertise, A. O. Smith continues to set the industry standard for performance and quality of water heaters, specialty heaters and storage tanks.



No other company is better qualified to fill your hot water needs.

Knowledgeable people at your service.

To better serve our customers, A. O. Smith has manufacturer's representatives covering the United States and Canada. In addition, we have more than 400 factory-authorized service technicians to provide reliable, immediate warranty services. We also maintain a well-staffed Customer Care Facility in Ashland City, Tennessee, that can provide information on A. O. Smith products, sizing, competitive analysis, etc.



Complete replacement parts support.

Our Parts Department carries replacement parts for every product A. O. Smith manufactures. We offer expert parts support and a wide range of shipping options. Our toll free parts order number, (800) 433-2545 is answered 7 a.m. to 5 p.m., Central time, Monday through Friday. The parts order fax, (800) 433-2515, is available 24 hours a day. Faxed orders received after 5:00 p.m. will be fulfilled the following business day.



A. O. Smith Customer Care Center

Our Technical/Product Support department is available from 7am to 7pm Monday through Friday and 8am to 5pm on Saturday (all hours are Central Time) at 1-800-527-1953. This group is highly skilled with over a hundred cumulative years experience in the water heating industry, HVAC, electrical, controls, plumbing, and more. We handle service referrals, warranty inquiries, general product questions as well as providing technical support to service and installing professionals



A. O. Smith has manufacturing facilities located worldwide.

Plants are located in strategic locations throughout the United States, providing timely shipments to wholesalers. In addition, manufacturing plants are also located in Nanjing, China, to supply the ever increasing demand for water heaters to the expanding Far East. Juarez, Mexico; Stratford, Ontario; and Veldhoven, The Netherlands provide commercial electric and gas energy-saving models.



A. O. Smith
500 Tennessee Waltz Parkway • Ashland City, TN 37015
PH 800.527.1953 • www.hotwater.com

*A. O. Smith reserves the right to make product changes
or improvements at any time without notice.*