

Model 8120 and 8126 Safety & Installation Instructions

FAMILIARIZE YOURSELF WITH THE INSTALLATION INSTRUCTIONS BEFORE STARTING

⚠ DANGER

ATTENTION INSTALLER:

To prevent serious injury from electrical shock this product must be installed by a qualified HVAC contractor.

⚠ DANGER

120 volts can cause serious injury from electric shock. Disconnect electrical power to the HVAC system before proceeding.

⚠ WARNING

Sharp metal edges can cause serious injury from cuts. Use gloves when cutting plenum openings and handling ductwork.

⚠ CAUTION

Do not mount the Vent Control on the supply plenum or duct. The unit will malfunction at heated temperatures and lose its calibration.

When installing the Vent Control on downflow furnaces, ensure blower continues to run after the heat call is satisfied to prevent high temperatures from damaging the Control circuit board.

Do not mount the Vent downstream from any fresh air intake port, humidifier or bypass outlet. False humidity conditions will cause the Vent Control to operate incorrectly.

INSTALLATION

STEP 1: REMOVE ITEMS FROM BOX

See **Figure 1**.

- A. MODEL 8120 VENT CONTROL
- B. OUTDOOR TEMPERATURE SENSOR
- C. TIME ONLY RESISTOR INSERT

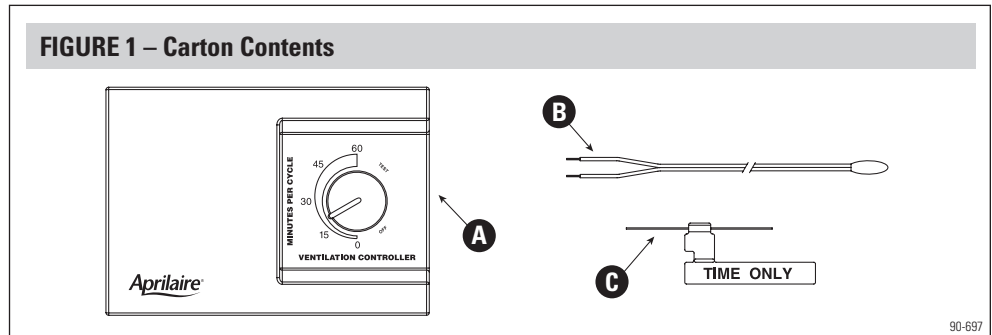

STEP 2: DETERMINE VENT CONTROL LOCATION AND INSTALL

- A. The Control must be installed in the return duct, at least 6 inches upstream of the fresh air intake opening, the humidifier if present, and/or the humidifier bypass duct opening. See **Figure 2**.
- B. For systems using flexible duct for return chases a mixing box might be necessary to locate the control. The mixing box can make it difficult to get the Control away from the fresh air duct port. Get it as close to the main return as possible, or located remotely from the fresh air opening.
- C. Then use the template (page 4) to cut the opening and mount the Control.

STEP 3: INSTALL INLET VENT, DUCTING (FLEX OR RIGID) AND DAMPER (INCLUDED WITH MODEL 8126)

- A. All duct work must be **insulated**. The damper assembly is heavy and requires support. Install the damper with the crimped end downstream. Insulate the damper assembly but leave the motor cover exposed to open air for adjustment access (see Damper Instruction sheet and **Figure 2**).
- B. If working with sharp metal edges wear gloves. For metal or flexible duct, seal joints with UL181 foil tape.
- C. Keep the inlet away from dryer or furnace vents, driveways, trash containers and swimming pools. Also the inlet vent should be above expected snow accumulation. Local codes might apply.
- D. The inlet vent should be a metal open hood model, plastic louvers will greatly cut airflow. Make sure the inlet hood has a screen. See **Figure 3**.

FIGURE 3 – Recommended Inlet Vent

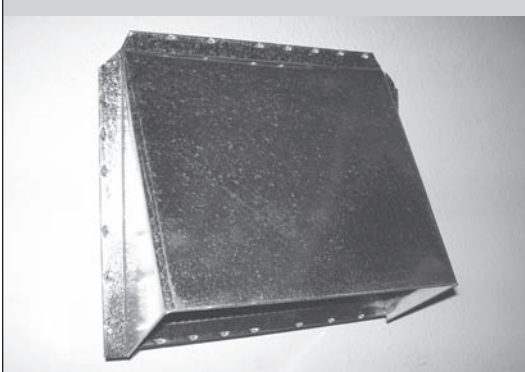
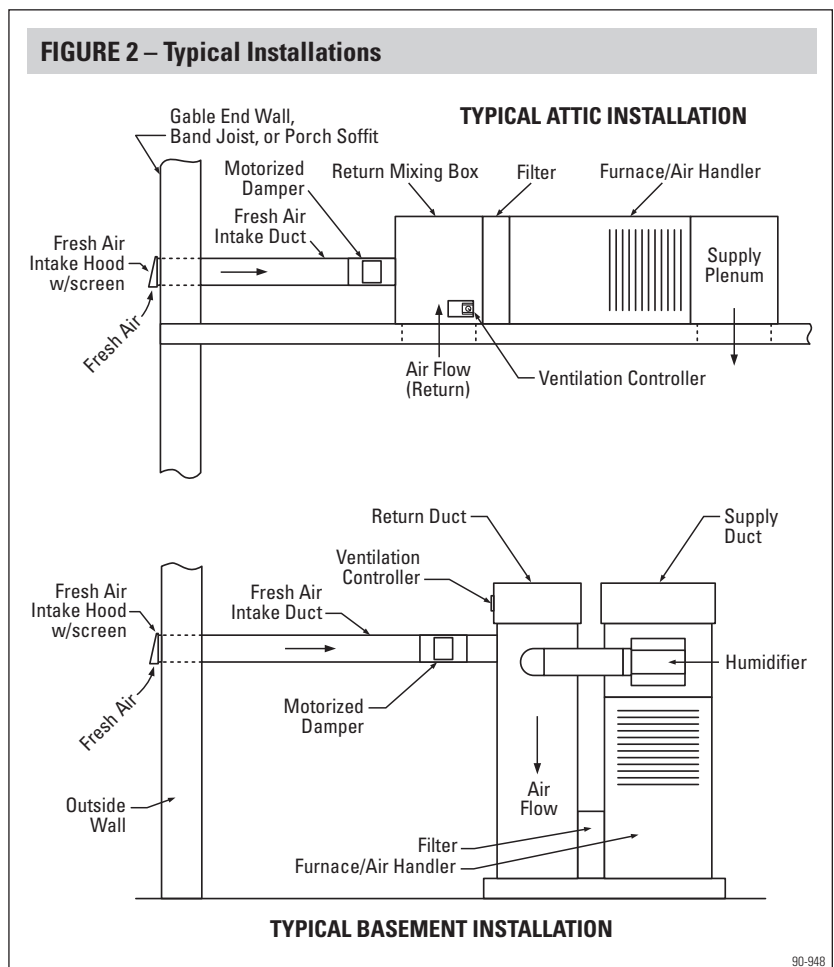
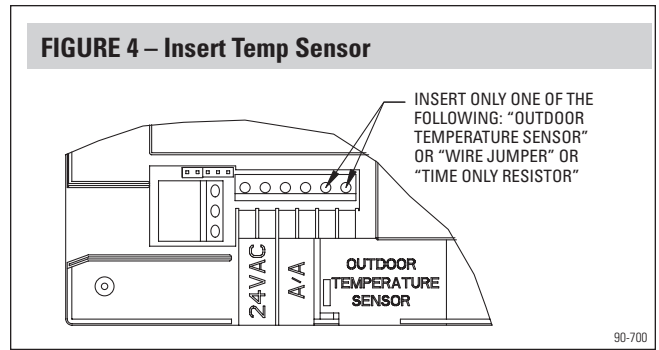

FIGURE 2 – Typical Installations



STEP 4: CHOOSE MODE OF OPERATION (W/OUTDOOR TEMP SENSOR, W/O TEMP SENSOR, OR TIME ONLY)

- A. By connecting the outdoor temperature sensor the Vent Control will run according to the timer settings, the indoor RH and the outdoor temperature. See Chart below and **Figure 4**.
- B. The outdoor temperature can be bypassed by jumpering the outdoor temp terminals with a wire. The Control will operate on the timer settings and the indoor RH only.
- C. Connecting the Time Only insert to the outdoor temp terminals will let the Vent run on Time Only. In this mode the Control's operation is not limited by the temperature and humidity limits as shown in Chart below.



SECTION A: Ventilation prevented due to temperature extremes and/or high indoor humidity.

SECTION B: Ventilation per the timer settings (Time Only).

SECTION C: Ventilation only with heat, per the timer settings.

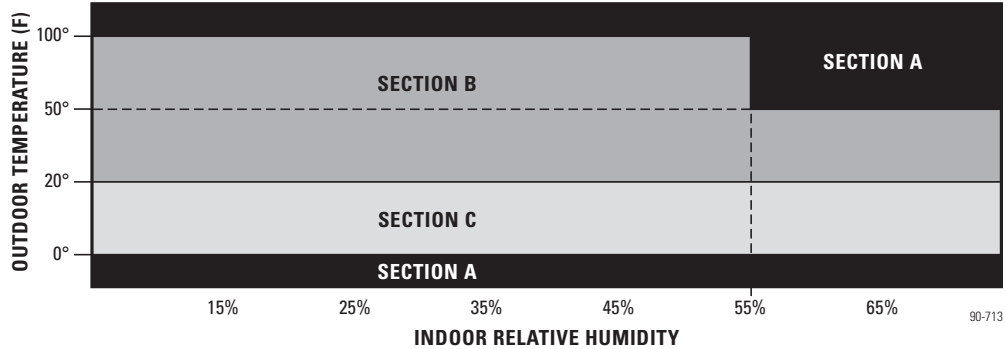

STEP 5: INSTALLING THE OUTDOOR TEMPERATURE SENSOR (IF OPTION A USED IN STEP 4)

The outdoor temperature sensor can be located in the fresh air duct or the vent inlet. The sensor cannot be exposed to the heat of direct sunlight. The lead lengths won't affect operation but don't route alongside 120 volt wires. Insert the stripped lead ends into the Outdoor Temperature Sensor terminals (see **Figures 4 and 5**).

STEP 6: WIRE THE VENT CONTROL TO THE HVAC SYSTEM

CAUTION

Improper wiring to the HVAC equipment can damage it or the Vent Control!

- A. When installing the Vent Control in a system with a Power Stealing thermostat, it is recommended that you set load resistors (300 ohm, 5 watt) across the Y & C terminals and the W & C terminals.
- B. Disconnect the thermostat lead from the HVAC terminal G and connect to the Vent Control G_S to STAT terminal. Connect a lead from the Vent Control terminal G_H to HVAC to the HVAC terminal G. The only wire connected to HVAC G will be from the Vent Control G_H to HVAC terminal.
- C. Route leads from the R, C and W terminals on the Vent Control to the corresponding terminals on the HVAC control board (see **Figure 5**). Leave any existing R, C and W leads in place.
- D. Install the 24 volt transformer (provided with Model 8126 only). The transformer should be continuously energized, do not wire to the HVAC blower circuit. The transformer, damper and the Vent Control DD terminals will be wired in series. Refer to **Figure 5** and the 6506 damper instructions for additional information.

DANGER

120 Volts can cause serious injury. Disconnect electrical power before proceeding!

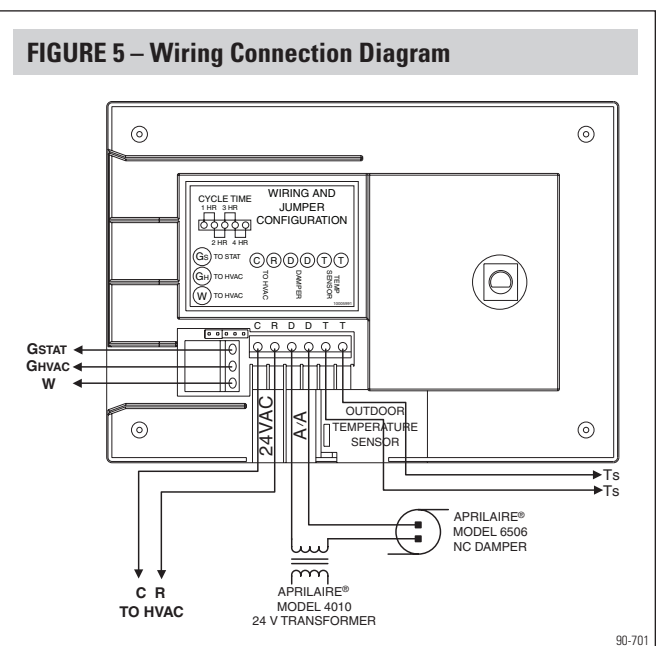

STEP 7: CALCULATE THE VENTILATION REQUIREMENT

A. The MINIMUM ventilation requirement is calculated using ASHRAE 62.2-2004.

ASHRAE Airflow In CFM = [House Area in Sq Ft x 0.01] + [No. Bedrooms +1 x 7.5]
Use the Number of Bedrooms (Plus 1) or the Number of Occupants, Whichever Is Larger

Additional ventilation may be required for pets, hobbies, fireplaces and attached garage, etc. Use your judgement.

B. This Table shows calculated airflow values at the nearest 5 CFM. If more outdoor air is required than the Vent Control can deliver, a 2nd device is advised. Consult with the homeowner.

C. Indicate the required CFM below.

HOUSE SQ FT	Minimum CFM Per Number Bedrooms				
	2	3	4	5	6
1000	35	40	50	---	---
1500	40	45	55	60	70
2000	45	50	60	65	75
2500	50	55	65	70	80
3000	55	60	70	75	85
3500	---	---	75	80	90

STEP 8: DETERMINE THE VENT CONTROL'S FRESH AIR DELIVERY RATE

AIRFLOW DELIVERY VS NEGATIVE STATIC PRESSURE AS MEASURED FOR RETURN DUCT OR PLENUM (IN WC)												
DUCT LENGTH	0.05		0.10		0.15		0.20		0.25		0.30	
	FLEX	PIPE	FLEX	PIPE	FLEX	PIPE	FLEX	PIPE	FLEX	PIPE	FLEX	PIPE
10 FT	60	65	85	90	105	110	120	125	135	140	150	160
20 FT	55	60	80	85	100	105	115	120	130	135	140	150
30 FT	50	55	75	80	95	100	110	115	125	130	130	140

A. Measure the negative static pressure of the return system and consult table above for approximate inlet airflow. But these values are estimates. An airflow measuring device (Nailor-Hart, etc.) will give the Vent Control's airflow exactly.

B. For the Table above the flex duct is **laid loose** with 2 **wide** 90° bends, and the damper is full open. For the rigid pipe the values are based on two 90° elbows, and the damper is open. For both cases the air intake is through a metal vent hood with a bird screen. Adjust airflow up or down for variations, including one elbow or bend, or the length of duct you're using isn't listed, etc.

C. Measure the delivered airflow or determine from above chart and record below.

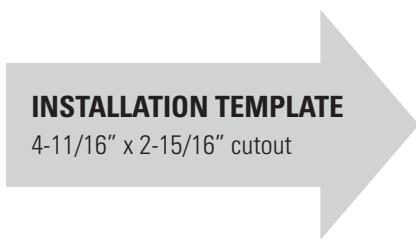

⚠ WARNING

Sharp edges can cause injury from cuts. Use gloves when cutting plenum openings or handling ductwork.

- ⚠ CAUTION**
- 1. Do not mount Vent Control on supply side. The unit will malfunction at heated temperatures.**
 - 2. When installing the Vent Control on downflow furnaces make sure blower continues to run after burner shuts off to prevent high heat damage to the Control**
 - 3. Do not mount the Vent Control downstream of the fresh air intake, or a humidifier or bypass outlet. False humidity levels can cause the Control to malfunction.**

STEP 9: SET THE SAMPLING TIME INTERVAL

- A. The Cycle Time Interval is the time period over which ventilation will occur. This is variable from 1 to 4 hours depending on customer preference. Keep in mind, once the Ventilation requirement is met the Vent Control won't run again until the start of the next cycle. The Cycle Time is the length of the sampling period, while the Ventilation time as set is the actual operating time.
- B. The device is factory set to a 1 hour sample time. This is recommended for a quicker reaction to conditions. Also the longer Cycle Intervals are more likely to require more than the 60 minutes available on the dial.
- C. Remove knob by carefully pulling it out from the case. Snap the cover off and refer to **Figure 7** to locate the cycle time setting tab and pins.
- D. The jumper tab on the 5 pin array determines the sampling time interval. Per diagram this can be 1,2,3 or 4 hours. The jumper tab is removed by pulling it straight out from the pins. Take care in replacing, do not bend.

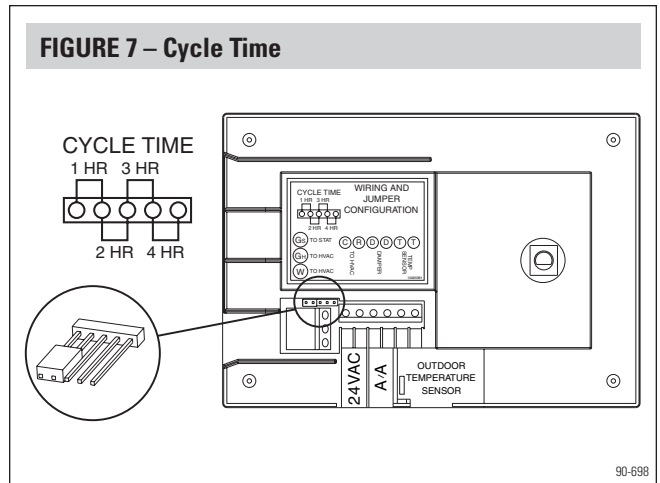

STEP 10: DETERMINE THE VENT CONTROL KNOB SETTING

- A. The run time in minutes is set with the knob. The Time 0 setting keeps the circuit live but the vent won't operate. OFF deactivates it completely. **Any setting made is the total running time per 1, 2, 3 or 4 hour cycle.**
- B. Record your entries from Steps 7C and 8C in the Table on page 6. From this you can determine the correct knob setting. For example, if 80 CFM is required but the Vent delivers 120 CFM set the knob to 40 minutes. The knob settings as listed are for a 1 hour cycle time.
- C. All values can be set except those in the black area. If the Vent Control is clocked out (black area) and if the cycle is set to 2, 3 or 4 hours, reset the pin jumper to get a settable time. For example, if 80 minutes is required at 2 hours, at 1 hour this would be a settable 40 minutes. If you're still clocked out or are already set to a 1 hour cycle consult with the homeowner about installing a second device.

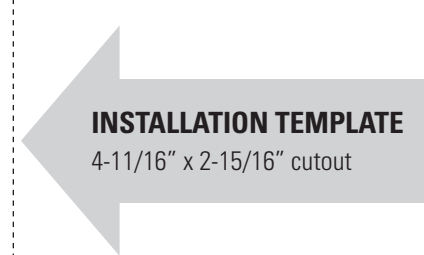
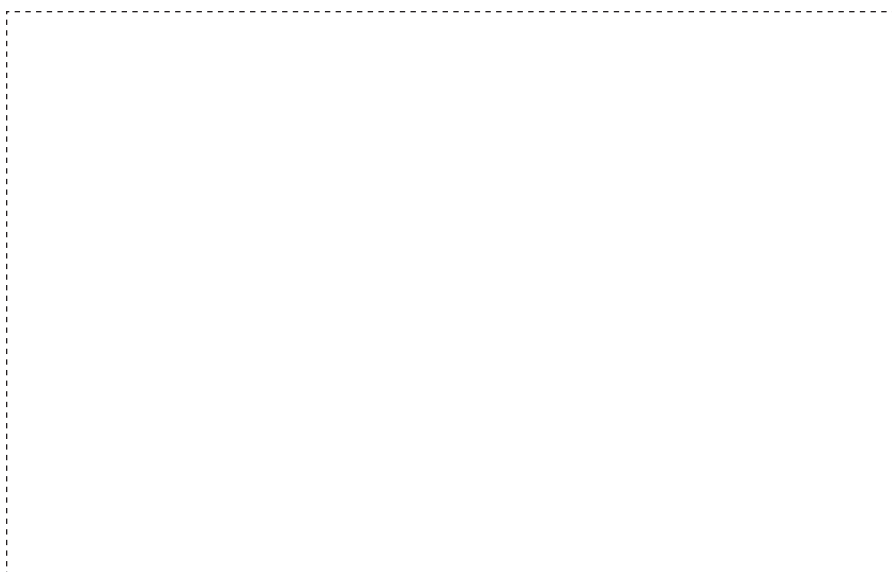
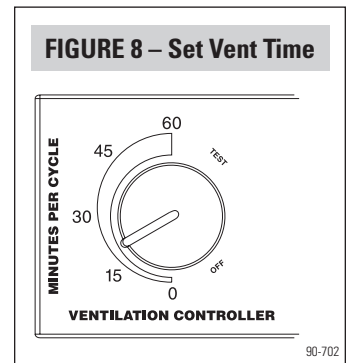

Step 7C		20	30	40	50	60	70	80	90	100
CFM Required >>										
Step 8C		KNOB SETTINGS (in minutes) FOR AIRFLOW DELIVERED vs AIRFLOW REQUIRED (1 HR CYCLE)								
CFM Delivered										
60		20	30	40	50	60	80	75	90	100
80		15	20	30	40	45	50	60	65	75
100		15	20	25	30	35	40	50	55	60
120		10	15	20	25	30	35	40	45	50
140		10	15	15	20	25	30	35	40	45
160		10	10	15	20	25	25	30	35	40

STEP 11: SYSTEM CHECK OUT

- A. For system test be sure that 24 VAC is applied in **series** with the 6506 damper (normally closed) and the A/A terminals on the Vent Control. Check the wiring as described in Step 6.
- B. Turn knob on Control dial to **TEST** position. If the installation is correct the blower will turn on (independent of heat or cooling operation) and the damper will open. The vent system will operate for 1 minute unless the knob is turned off of **TEST**. If system does not operate in the **TEST** Mode check the Troubleshooting Guide.
- C. Return knob to the calculated setting. **Do not leave in TEST, the Vent Control won't operate normally.**

TROUBLESHOOTING

PROBLEM	TROUBLESHOOTING PROCEDURE
HVAC Blower doesn't turn on in Test Mode.	<ol style="list-style-type: none"> 1. Make sure you turned the power back on to the HVAC equipment. 2. Check the wiring diagram for the R, C, W and GSTAT and GHVAC at both the HVAC equipment and the Vent Control. 3. Make sure the Outdoor Sensor Terminals on the Control are connected with either the Temperature Sensor, the Time Only Insert or a jumper wire. If nothing is connected here the Control will not function. 4. Check voltage across the Vent Control R&C terminals. Voltage should be in the 22 VAC to 30 VAC range. 5. Remember, once the Test minute is up the system won't operate.
Damper does not open in Test.	<ol style="list-style-type: none"> 1. Follow above procedure. 2. Check wiring diagram to make sure the damper is wired in series with the circuit board and transformer.
The Vent Control doesn't turn off after the knob is turned off Test.	<ol style="list-style-type: none"> 1. This might be okay, the thermostat might have activated. Also the blower might be set up for continuous operation. The Vent Control should deactivate once the time setting is reached. 2. If the pins are set to 1 hour and the knob is turned to 60 minutes the Vent Control will not turn off. But for a 2 hour pin setting, if the knob is at 60 minutes, at the end of that 60 minutes the Vent will turn off.
The damper does not open with the blower operating.	<ol style="list-style-type: none"> 1. The damper will not operate once the time interval has been met. If the knob is turned to 5 minutes and 5 minutes has elapsed, the damper will close and it will stay closed until the pin setting interval is met. 2. If the Indoor RH is above 55% and the outdoor temperature is above 50° the damper will not open because of the potential for excess humidity. 3. If the outdoor temperature is below 0° or above 100° the vent stays off. 4. Verify that the outdoor temperature sensor is located within 3 feet of the vent inlet, or if located outside that it's not in direct sunlight at any time. 5. Turbulence in the return duct, plenum or mixing box can give false readings. Make sure the Vent Control is at least 6 inches upstream of the fresh air intake port in the return to minimize this effect.
Blower turns on unexpectedly.	<ol style="list-style-type: none"> 1. The Vent Control will activate the blower whether or not heat or A/C is on call. This ensures ventilation even if the thermostat is lowered. 2. To verify proper operation see if the blower turns off by turning down the knob. Return to its original setting.