

Product Guide

Residential Ventilation

Aprilaire[®]
Your Partners in Comfort[®]



Aprilaire sets a new direction in residential ventilation with whole-home solutions based on building requirements, geographic climate zones and effective applications.

Effectively deliver the required amount of fresh air.

Meets/Exceeds
ASHRAE Standards 62.2-2010 62.2

Aprilaire Residential Ventilation

For over 75 years, Aprilaire has been committed to the success of HVAC contractors and residential builders by providing solutions designed for consumer health, comfort, protection and energy savings. Our new suite of ventilation products continues that tradition.

Aprilaire ventilation products utilize air delivery methods, effective and convenient controls and geographic considerations to deliver industry-leading solutions. The health and safety concerns associated with tight homes, such as those identified by the Environmental Protection Agency, can be eliminated with the proper application of whole-home ventilation products. Aprilaire and its HVAC contractor partners deliver ventilation solutions that are effective and economical.



One of the top five environment health concerns is indoor air quality in new homes

"Indeed, studies of human exposure to air pollutants by EPA indicate that indoor levels of pollutants may be 2 to 5 times – and occasionally more than 100 times – higher than outdoor pollutant levels. Indoor air pollutants have been ranked among the top five environmental risks to public health."

epa.gov/region1/communities/indoorair

Tightly Constructed Homes and Energy Efficiency

Many successful builders use energy efficient building materials and techniques to differentiate their business and drive sales for existing homes and new construction. When a home is built tight it's critical to ventilate properly.

Compare Efficiency

Resale Home
2-Story, 3000 Sq. Ft.
Estimated Electrical Bill



New Home
2-Story, 4000 Sq. Ft.
Estimated Electrical Bill



beazer.com/energy-efficiency

Supply Ventilation for Whole-Home Effectiveness

Many manufacturers are promoting spot (single point) ventilation as a solution for whole-home requirements. They suggest you can simply increase the CFM of bathroom and kitchen exhaust fans. Although this approach will meet the standard, the complete mechanical whole-home ventilation solution utilizes the HVAC system to properly condition the air and distribute it throughout the living space.



In testing exhaust and supply ventilation systems and their effect on indoor air quality, the US Department of Energy determined that supply ventilation provided a significantly more efficient and effective solution:

Single-point ventilation is not the answer.

“Exhaust ventilation testing showed lower uniformity of outdoor air exchange rate between living space zones, and higher concentrations of particulates, formaldehyde, and other Top 20 VOCs than did the supply and balanced ventilation systems. This showed that **single-point exhaust ventilation was inferior as a whole-home ventilation strategy** because the source of outside air was not directly from outside (much of it came from the attic), the ventilation air was not distributed, and no provision existed for air filtration.”

US Department of Energy - Ventilation System Effectiveness and Tested Indoor Air Quality Impacts - February 2014

The Bathroom Door Paradox

When the homeowner closes the bathroom door it will impact the efficiencies of spot (single source) ventilation. Spot ventilation systems are designed to remove moisture from the bathroom to satisfy whole-home ventilation requirements.



Ventilation Delivered through the HVAC System

WHOLE-HOME BENEFITS

The HVAC system is designed to condition the air and deliver it throughout the entire home. Combining an Aprilaire ventilator with an existing HVAC system delivers the required amount of whole-home fresh air ventilation at the lowest cost to the consumer.

WHOLE HOME COVERAGE

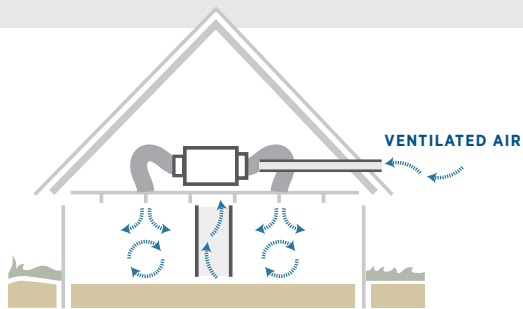

Aprilaire ventilators utilize existing HVAC ducting systems to deliver air throughout the home.

CONTROLLED AIR SOURCE

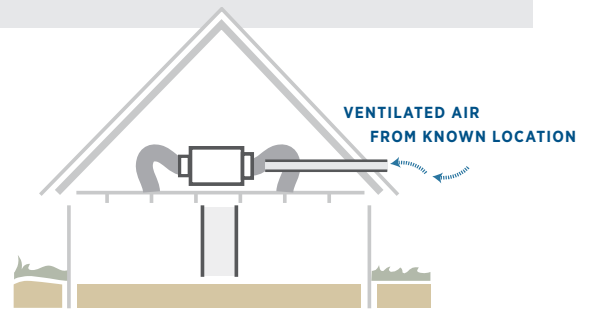

The source of the ventilated air is known.

AIR PRE-CONDITIONED

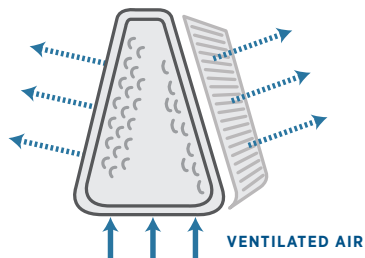

Ventilated air is delivered to the air conditioning evaporator coil to remove moisture.

POSITIVE PRESSURE

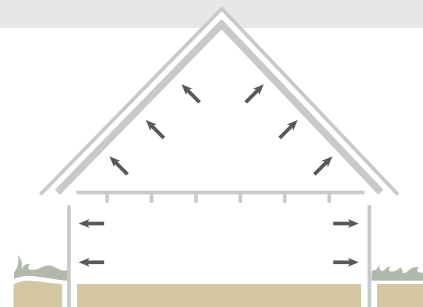

Positive pressure eliminates safety concerns from combustible appliances back drafting and is easy to measure (CFM).

Combine an Existing HVAC System with an Aprilaire Ventilator for:

EASY INSTALLATION

EFFICIENT OPERATION

All Applications, All Codes



All home types and HVAC equipment can be easily equipped with Aprilaire ventilation solutions.

BASEMENT
ATTIC
CRAWLSPACE

CLOSET
GARAGE

Building Codes, Energy Programs, Raters

Using the right products that meet all building codes simplifies the inspection/rating process for ventilation. Turn to Aprilaire and your local HVAC contractor to insure the proper CFM is delivered to the whole-home with blowers that meet efficacy requirements.

Aprilaire ventilation products meet all building codes.

REQUIREMENTS:

- ✓ Energy Star Certified Homes, Version 3
- ✓ EPA Indoor airPLUS, Version 1
- ✓ 2012 & 2015 International Residential Code (IRC)
- ✓ 2012 & 2015 International Energy Conservation Code (IECC)
- ✓ California Energy Commission Title 24

Climate Zones

Managing the quality of ventilated air delivered into the home is critical to providing a healthy indoor environment. The requirements change significantly based on climate. Aprilaire ventilation solutions work with the HVAC equipment to remove moisture, harmful particulates and other contaminants such as VOC's. It's critical to use adequate ventilation controls and application guidance to properly ventilate rather than to simply pull air through walls with local exhaust ventilation.

Marine

Dry

Moist

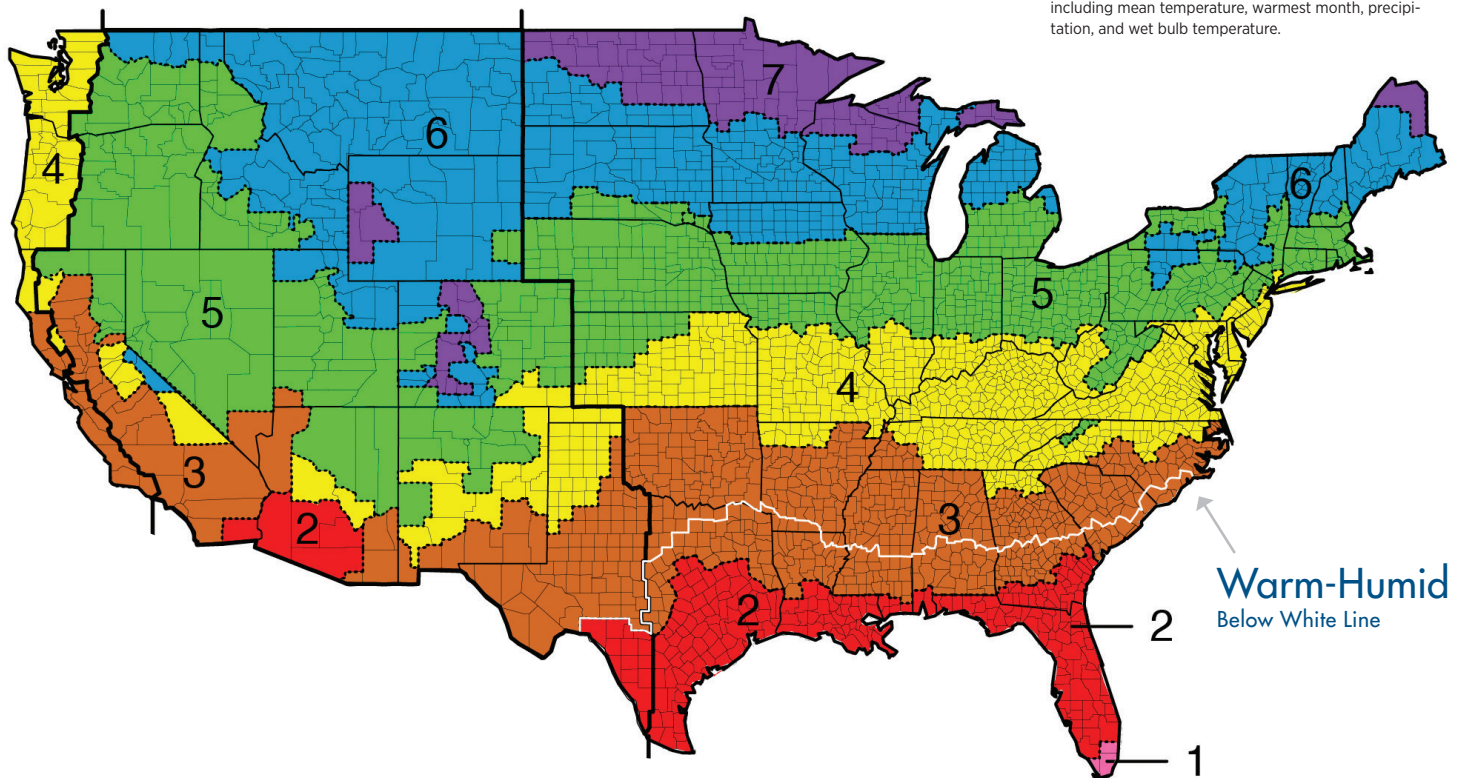

Use this map and the adjoining application guide to determine the recommended product solution for your climate. These recommendations are based on moisture removal demands, energy savings, and integration with the HVAC equipment.

ZONE	CLIMATE TYPE	MAJOR CITIES	PRIMARY SOLUTION ₁	FRESH AIR DUCTED ₂	ALTERNATE SOLUTION ₃	VENTILATION PRODUCT APPLICATION GUIDANCE
1	Hot & Moist	Miami	8191 or 8192	HVAC Return	8140	High humidity climate zone with elevated moisture levels all year. Remove humidity prior to the air entering the house with the Models 8191/8192. A lower cost installation but less effective solution uses the 8140 in conjunction with the home's cooling system.
2	Hot & Moist	Orlando, Mobile, New Orleans, Houston, Austin, San Antonio	8191 or 8192	HVAC Return	8140	High humidity climate zone with elevated moisture levels all year. Remove humidity prior to the air entering the house with the Models 8191/8192. A lower cost installation but less effective solution uses the 8140 in conjunction with the home's cooling system.
2	Hot & Dry	Phoenix, Tucson, S. California	8141 or 8142	HVAC Supply	N/A	Install the fresh air ventilator to the supply side of the HVAC system to ensure distribution of warmer ventilation air when HVAC system is not running. (humidity control in this climate zone is unnecessary). Supply side installations do not require a powered damper. Choose the 8141 or 8142 depending on ease of installation and filter accessibility.
3	Warm & Moist	Charlotte, Charleston, Atlanta, Little Rock, Oklahoma City, DFW	8191 or 8192	HVAC Return	8140	This climate zone can have moisture in the air for an extended periods. Remove humidity prior to the air entering the house with the Models 8191/8192. The 8140 operating in conjunction with the home's cooling system is a good low cost solution as humidity levels are lower during late fall/winter/early spring.
3	Warm & Dry	El Paso, Las Vegas, Los Angeles, Sacramento	8141 or 8142	HVAC Supply	N/A	Install the fresh air ventilator to the supply side of the HVAC system to ensure distribution of warmer ventilation air when HVAC system is not running. (humidity control in this climate zone is unnecessary). Supply side installations do not require a powered damper. Choose the 8141 or 8142 depending on ease of installation and filter accessibility.
3	Warm & Marine	San Francisco, San Jose	8141 or 8142	HVAC Supply	8140	Temperatures and humidity levels are not too extreme. To minimize cost, install 8141 or 8142 ducted to the supply side of the HVAC system, or if access restricts where the air can enter the system, use the 8140 when ducting to the return side.
4	Mixed & Moist	Philadelphia, Washington, Baltimore, Nashville, St. Louis, Wichita, Louisville	8140	HVAC Return	8191 or 8192	Humidity levels are high in the summer and early fall/late spring. Install the 8140 and duct to the return side of the HVAC equipment to work in conjunction with operation of the cooling system. Alternatively, to ensure dry air is delivered year round, install the 8191/8192.
4	Mixed & Dry	Albuquerque, Amarillo	8141 or 8142	HVAC Supply	8140	Install the fresh air ventilator to the supply side of the HVAC system to ensure distribution of warmer ventilation air when HVAC system is not running. (humidity control in this climate zone is unnecessary). Supply side installations do not require a powered damper. Choose the 8141 or 8142 depending on ease of installation and filter accessibility.
4	Mixed & Marine	Portland, Seattle	8141 or 8142	HVAC Supply	8140	Temperatures and humidity levels are not too extreme. To minimize cost, install 8141 or 8142 ducted to the supply side of the HVAC system, or if access restricts where the air can enter the HVAC system, use the 8140 when ducting to the return side.
5	Cool & Moist	Boston, Pittsburgh, Columbus, Indianapolis, Detroit, Chicago, Des Moines, Omaha	8140	HVAC Return	N/A	Humidity levels are high in the summer and early fall/late spring. Install the 8140 and duct to the return side of the HVAC equipment to work in conjunction with operation of the cooling system. During winter the 8140 will bring in outdoor air when the heating is on.
5	Cool & Dry	Denver, Salt Lake City, Boise, Reno	8140	HVAC Supply or Return	8141 or 8142	Install the fresh air ventilator to the return side of the HVAC system and wire the control to turn on the system's fan with ventilation to ensure good air mixing in the winter. If good mixing can be achieved with the fresh air duct installed on the supply side, then the 8141 or 8142 is the less expensive option.
6	Cold & Moist	Toronto, Vancouver, Milwaukee, Madison, Minneapolis-St Paul, Sioux Falls	8140	HVAC Return	N/A	Install the fresh air ventilator to the return side of the HVAC system and wire the control to turn on the system's fan with ventilation to ensure good air mixing in the winter. Dehumidification is also a benefit from return side installation.
6	Cold & Dry	Helena, Cheyenne	8140	HVAC Return	N/A	Install the fresh air ventilator to the return side of the HVAC system and wire the control to turn on the system's fan with ventilation to ensure good air mixing in the winter.
7	Extreme Cold & Moist	Fargo, Duluth, Calgary, Edmonton	8140	HVAC Return	N/A	Install the fresh air ventilator to the return side of the HVAC system and wire the control to turn on the system's fan with ventilation to ensure good air mixing in the winter.



The 8126A system will work in all climate zones as a low cost ventilation solution.

₁ Primary Aprilaire recommended supply ventilation solution for optimum performance and building code adherence.
₂ HVAC application considerations based upon moist verses dry air, and proper mixing into the ductwork.
₃ Alternate solution, will minimally meet ventilation requirements but not optimally.

Ventilation Control

Aprilaire ventilation control manages ventilated air based on its temperature and relative humidity. In all applications the air will be delivered to ASHRAE Standards 62.2-2010 ventilation requirements and 2.8 CFM/watt fan efficacy.

Energy Savings

Aprilaire ventilation controls will automatically lock out ventilation during extreme temperatures and recover the required ventilation when temperatures are more moderate.

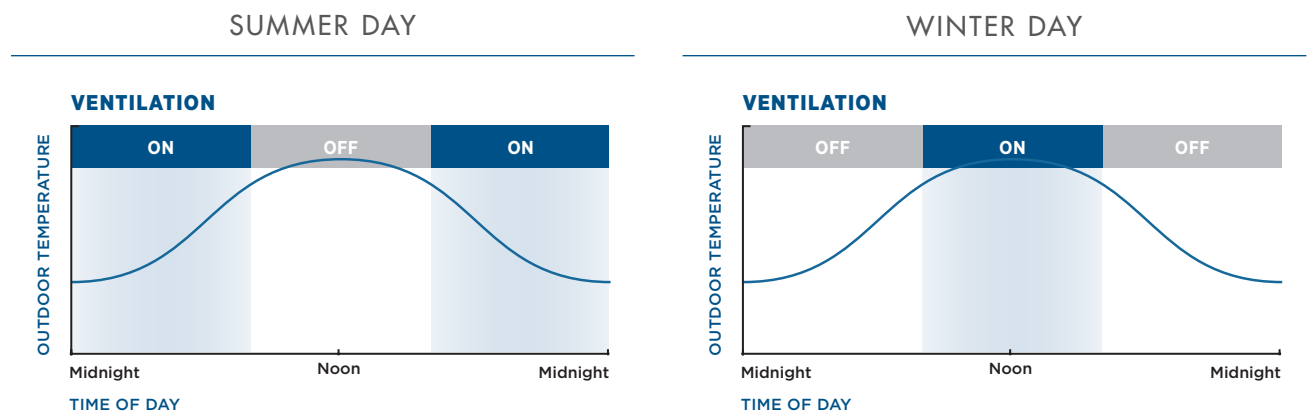

Charts above are for illustration purposes.

Moisture Control

It simply does not make sense to ventilate moist air into a tight home.

WARM HUMID

Aprilaire ventilation will deliver outside air through the air conditioning evaporator coil, removing moisture prior to entering the living space. No additional energy is required to remove moisture because the air conditioning system is already running.

HOT HUMID (TROPICAL)

Aprilaire ventilation will deliver outside air through the air conditioning evaporator coil, removing moisture prior to entering the living space. When the air conditioning is not running, the ventilated air will be conditioned with a dedicated dehumidifier. This strategy uses additional energy only when it's required.

Air Quality

Aprilaire ventilation controls the source of the air delivered into the home. In addition, if the HVAC system is installed with a high-performance air cleaner, the ventilated air will be filtered, permanently trapping particulates that can be troublesome to allergy and asthma sufferers.

8140 VENTILATOR WITH **POWERED DAMPER** & FILTER

8141 VENTILATOR WITH **BACKDRAFT DAMPER** & FILTER

SPECIFICATIONS

Overall Dimensions	11.9" H x 14.4" W x 27.8" L
Inlet Collar	6" Round
Outlet Collar	6" Oval
Ventilation Time Dial Setting	Off, 15-60 minutes, (5 min. increments), Test/Reset
Ambient Temperature	0°F to 160°F
Outdoor Temperature	Setting "A", no limit, time only
Limit Settings	"B", 105°F high limit, 20°F low limit "C", 100°F high limit, 30°F low limit "D", 95°F high limit, 40°F low limit
Voltage	115 VAC, 1 phase, 60 Hz
Power	Includes 5' power cord with 3 prong plug
Ducting	6" diameter flexible insulated duct
Warranty	5 years
ETL	Tested to UL Standard 705 - Power Ventilators Not For Outdoor Use

PERFORMANCE

Static Pressure* (in WC)	Airflow (CFM)	Current (amps)	Power (watts)	Efficacy (CFM/watt)
0.0	285	0.4	53	5.39
0.2	250	0.4	53	4.70
0.4	195	0.4	52	3.75
0.6	130	0.4	50	2.62
0.8	25	0.4	44	0.52

* Measured across ventilator.

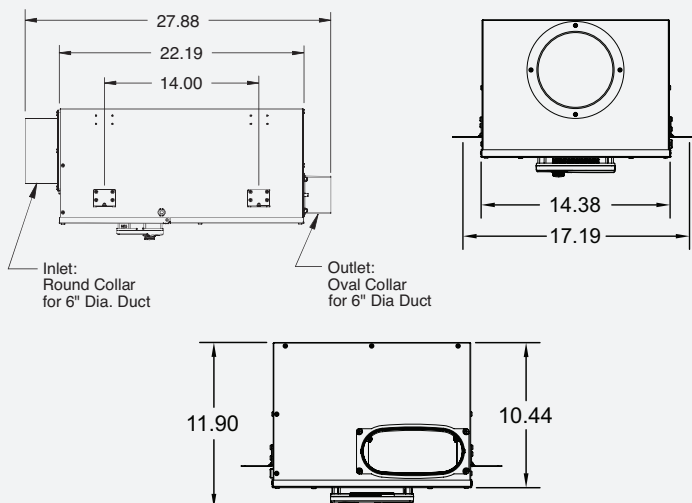

FEATURES

- + Unit is designed, when properly installed, to achieve ASHRAE STANDARDS 62.2-2010
- + Operates a minimum of one hour out of every four to meet 2012/2015 IRC requirements
- + Control is integrated into the ventilator
- + High and Low Temperature Limit Lock-outs while maintaining ASHRAE STANDARDS 62.2-2010 Simple plug-in installation
- + Integrated powered damper (Model 8140 Only)
- + Removable, washable filter

BENEFITS

- + Delivers the precise amount of outside air needed in today's efficiently designed homes
- + Optimizes energy savings by locking out ventilation during hottest/coldest times of the day
- + Improves indoor air quality
- + Robust design handles hot attics up to 160°F
- + Installation labor reduced, requires only a switched outlet and 24 volt wiring to HVAC system
- + Furnace or air handler does not require an ECM motor to meet efficacy requirement

▶ **When properly installed and set, the Aprilaire Models 8140 and 8141 Fresh Air Ventilators will meet the mechanical ventilation requirements of:**

- + Energy Star Certified Homes, Version 3
- + EPA Indoor airPLUS, Version 1
- + 2012 & 2015 International Residential Code (IRC)
- + 2012 & 2015 International Energy Conservation Code (IECC)
- + California Energy Commission Title 24

8142 VENTILATOR WITH BACKDRAFT DAMPER NO FILTER

SPECIFICATIONS

Overall Dimensions	6.6" H x 13.1" W x 13.4" L including control
Inlet Collar	6" Round
Outlet Collar	6" Oval
Ventilation Time Dial Setting	Off, 15-60 minutes, (5 min increments), Test/Reset
Ambient Temperature	0°F to 160°F
Outdoor Temperature Limit Settings	Setting "A", no limit, time only "B", 105°F high limit, 20°F low limit "C", 100°F high limit, 30°F low limit "D", 95°F high limit, 40°F low limit
Voltage	115 VAC, 1 phase, 60 Hz
Power	Includes 5' power cord with 3 prong plug
Ducting	6" diameter flexible insulated duct
Warranty	5 years
ETL	Tested to UL Standard 705 – Power Ventilators Not For Outdoor Use

PERFORMANCE

Static Pressure* (in WC)	Airflow (CFM)	Current (amps)	Efficacy (CFM/watt)
0.0	245	0.63	3.30
0.2	220	0.64	2.96
0.4	190	0.64	2.57
0.6	160	0.63	2.12
0.8	120	0.61	1.69
1.0	95	0.60	1.35

* Measured across ventilator.

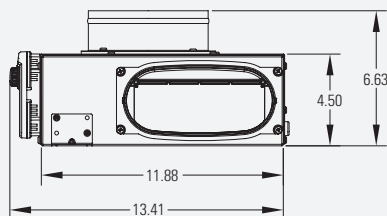
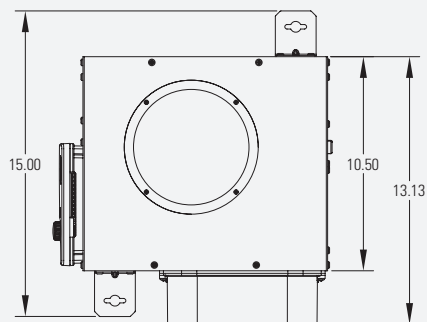

FEATURES

- + Unit is designed, when properly installed, to achieve ASHRAE Standards 62.2-2010
- + Operates a minimum of one hour out of every four to meet 2012/2015 IRC requirements
- + Control is integrated into the ventilator
- + High and Low Temperature Limit Lock-outs while maintaining ASHRAE Standards 62.2-2010
- + Simple plug-in installation

BENEFITS

- + Delivers the precise amount of outside air needed in today's efficiently designed homes
- + Optimizes energy savings by locking out ventilation during hottest/coldest times of the day
- + Improves indoor air quality
- + Robust design handles hot attics up to 160°F
- + Installation labor reduced, requires only a switched outlet and 24 volt wiring to HVAC system
- + Furnace or air handler does not require an ECM motor to meet efficacy requirement

When properly installed and set, the Aprilaire Model 8142 Fresh Air Ventilator will meet the mechanical ventilation requirements of:

- + Energy Star Certified Homes, Version 3
- + EPA Indoor airPLUS, Version 1
- + 2012 & 2015 International Residential Code (IRC)
- + 2012 & 2015 International Energy Conservation Code (IECC)
- + California Energy Commission Title 24

8126A VENTILATION SYSTEM

SPECIFICATIONS

Overall Controller Dimensions	4.25" H x 6" W x 1.75" D
Duct Opening Dimensions (for humidity sensor)	0.75" DIA Hole
Input Power for the Control (from the HVAC system transformer)	24 VAC, 1 VA
Damper Outputs (A/A)	1A max. at 24 VAC
Outdoor Temperature Sensor Inputs	Thermistor (provided)
Damper Transformer (provided)	24 VAC, 10 VA
Cycle Time	1 hour
Ventilation Time Dial Setting (minutes per cycle)	Off, 0-60, Test/Reset

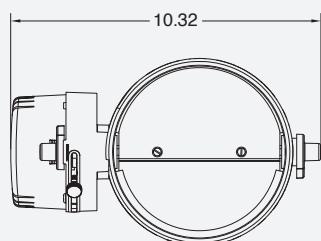
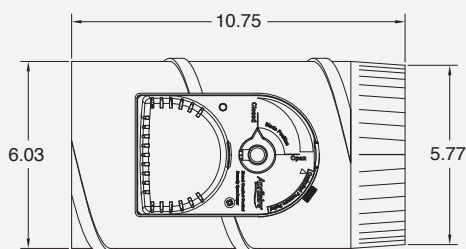
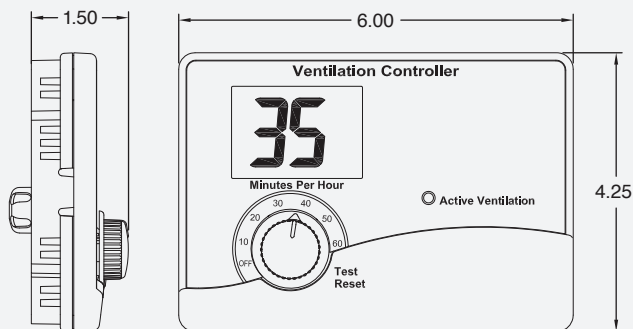

FEATURES

- + Separate ventilation time adjustment
- + Separate cycle time adjustment
- + Minimum off times between cooling call and unsolicited blower call (UBC)
- + 24-Volt control
- + Measures outdoor temperature to stop ventilation at extremely hot or cold outdoor temperatures
- + Measures indoor relative humidity, preventing home indoor RH from exceeding 60%
- + Installation flexibility - ability to override humidity and temperature control

BENEFITS

- + Controls that satisfy your customers' needs
- + Allows fan to cycle, increasing air cleaner and humidifier run times
- + Allows coil to drain before running fan to prevent moisture from being added back into the home
- + Easy to install, saving you time & money
- + Increased customer comfort and energy savings over other economical ventilation options
- + Allows you to meet every application

8191/8192 VENTILATOR WITH DEHUMIDIFICATION



SPECIFICATIONS AND SIZING SUMMARY

MODEL	8191	8192
Nominal Ventilation Airflow (CFM)	100 CFM	200 CFM
Capacity ⁽¹⁾ pints/day	70 ppd	95 ppd
Energy Factor ⁽¹⁾	1.91 L/kW-h	2.2 L/kW-h
Energy Star Qualified	Yes	No
Air flow @ various external static pressure - dry coil		
0.0 in WC	160 CFM	265 CFM
0.2 in WC	120 CFM	230 CFM
0.4 in WC	70 CFM	200 CFM
Voltage, Phase, Frequency	120VAC, 1, 60 Hz	
Current Draw ⁽¹⁾	6.3 amps	8.0 amps
Sound Level	47 dBA ducted	54 dBA ducted
	51 dBA unducted	
Dimensions - cabinet only		
Width	12.5"	12.5"
Height ⁽²⁾	14.5"	14.5"
Length	25"	27.5"
Weight	70 lbs	75 lbs
Operating Condition		
Inlet Air Operating Conditions	50°F - 104°F, 40°F dew point min.	
Ambient/Ventilation	40°F - 140°F, 0% - 99% RH	

⁽¹⁾ Rated capacity and Energy Factor test done and current draw measure in accordance with AHAM DH-1 2008 at 80°F/60%RH inlet air at 0.0 ESP.

⁽²⁾ Height does not include adjustable feet or casters. The width excludes the filter doors, and length excludes the duct collars.

SPECIFICATIONS

Control	Built-in digital control with display
Control Mounting Option	Field interchangeable from top to front
Cabinet Insulation	1/2" EPS
Air Discharge Orientation	Top or end air discharge
Inlet/Outlet Duct Collars	10" round
Back Damper at Outlet	Included
Air Filter	Washable MERV 8
Refrigeration	R-410A
Coil Corrosion Resistance	E-coated coil
8' Power Cord Type	Plug type
Drain Connection	3/4" PVC adapters ⁽¹⁾
Warranty	5 years

⁽¹⁾ Thread adapter and barbed fitting for clear drain tubing included.

FEATURES

- + Removes moisture from outdoor air before it enters the live space
- + Unit is designed, when properly installed, to achieve ASHRAE Standards 62.2-2010
- + Control is integrated into the unit
- + High and Low Temperature Limit Lock-outs
- + Simple plug-in installation
- + Installation temperature range up to 140°

BENEFITS

- + Helps control RH in the home during periods when the air conditioning system does not run long enough to remove sufficient moisture. If air conditioner can satisfy RH requirements the Aprilaire unit's compressor shuts off
- + Optimize energy savings by locking out ventilation during hottest/coldest times of the day
- + Improves indoor air quality
- + Installation labor reduced, requires only a power outlet and 24 volt wiring to HVAC system

When properly installed and set, the Aprilaire Model 8191 and Model 8192 Ventilators with Dehumidification will meet the mechanical ventilation requirements of:

- + Energy Star Certified Homes, Version 3
- + EPA Indoor airPLUS, Version 1
- + 2012 & 2015 International Residential Code (IRC)
- + 2012 & 2015 International Energy Conservation Code (IECC) – 8191 Only

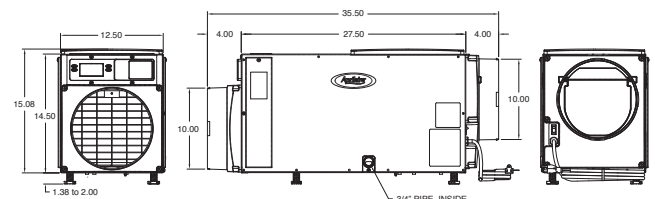

8000 Series	APRILAIRE VENTILATORS	MODEL NO.	UNIT SIZE width x height x depth	WEIGHT lbs.	AIRFLOW (CFM) @ 0.2 in WC	DEHUMIDIFICATION CAPACITY pints per day	WARRANTY
		8126A	10.8" x 9.3" x 6.0"	5	-	-	
		8140	27.8" x 14.4" x 11.9"	20	250 CFM	-	
		8141	27.8" x 14.4" x 11.9"	18	250 CFM	-	
		8142	13.4" x 13.1" x 6.6"	12	220 CFM	-	
		8191	25.0" x 12.5" x 14.5"	70	120 CFM	70 ppd	
	8192	27.5" x 12.5" x 14.5"	75	230 CFM	95 ppd		

Ventilation Control Logic Integrated into Aprilaire Thermostats

Model 8620
8620W with IAQ Control



- + Universal 2H/2C or 4H/2C HP
- + Event-Based™ Air Cleaning
- + Humidity or Ventilation
- + Wi-Fi touch screen (8620W)

Model 8910
8910W with IAQ Control



- + Universal 3H/3C or 4H/2C HP
- + Event-Based™ Air Cleaning
- + Humidity and Ventilation
- + 2 Part - 3-Wire design
- + Wi-Fi touch screen (8910W)

Model 8920W
with IAQ Control



- + Universal 3H/3C or 4H/2C HP
- + Event-Based™ Air Cleaning
- + Humidity and Ventilation
- + 2 Part - 3-Wire design
- + Full color Wi-Fi touch screen