

# SHARKBITE®

## 2016 CATALOG



# SHARKBITE

## THE MARK OF QUALITY

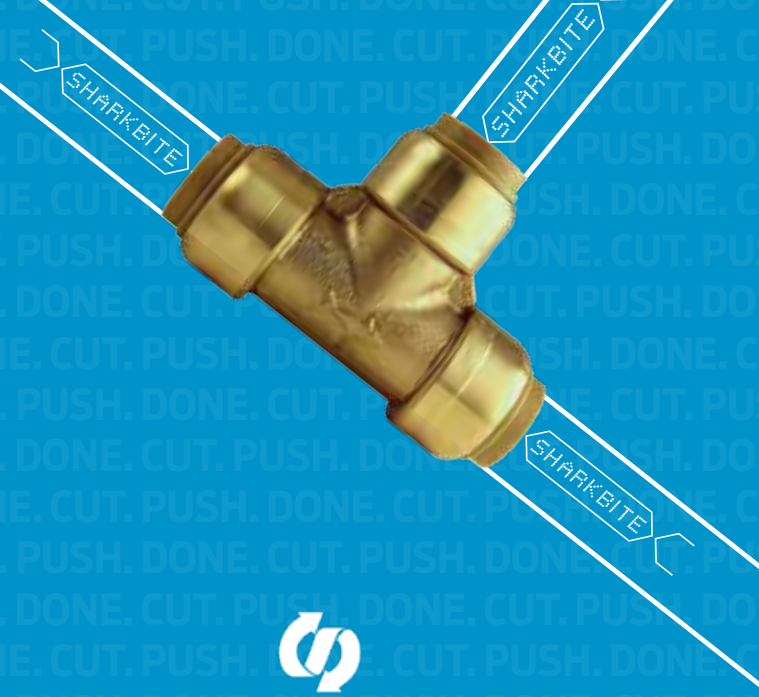

### LEAD-FREE/SAFETY\*

All SharkBite® fittings are made of Lead Free DZR brass and exceed ASSE 1061 Section IV, 4.1 Materials-Dezincification (DZR)-ISO 6509 standards.

*\*Reference Page 26 for additional information.*



### VERSATILE

The ultimate range of push-to-connect plumbing fittings-the SharkBite Connection System has really taken hold with its ability to join Copper, CPVC, PEX or PE-RT pipe in any combination.



### PROVEN AND GUARANTEED

In 1999, SharkBite became the first push-to-connect fitting to be release into the market. Manufacturing 100% of the components to our fittings and never outsourcing production to a 3rd party, we own the entire manufacturing process. All products are stamped with a manufacturing date and as of 2015, \$75M has been invested towards improvement and additions to our products. With over 1.5M successful SharkBite connections made each week, SharkBite continues to be the market leader in "push-to-connect" products.



### NO TOOLS

No glue, solder, clamps or unions required when using SharkBite fittings, providing a quick and easy application that saves installers time, labor, and money.



### FLEXIBILITY

SharkBite fittings can be rotated even after assembly allowing for easier installation in tight places.



### RANGE

With the largest range of fittings in the industry, SharkBite SKU selection carries sizes ranging form 1/4"-2".

### CERTIFICATIONS

- Approved to be used underground and behind walls without access panels
- Fittings are certified to 200 °F (93 °C) max and 200 PSI max
- Design certified to ANSI/NSF-61 and ASSE 1061 product standard for use in potable water and hydronic heating water distribution

# TABLE OF CONTENTS

<b>SECTION 1: THE SHARKBITE CONNECTION SYSTEM</b>	<b>3</b>
1-A: Core Fittings	3
1-B: Radiant Fittings	7
1-C: Transition Fittings	7
1-D: Fire Fittings	8
1-E: Flex Hoses	8
1-F: Stops & Fixture Supply Fittings	9
1-G: Additional Products	10
1-H: Kits	10
1-I: Tools	11
<b>SECTION 2: SHARKBITE VALVES</b>	<b>12</b>
2-A: Pressure Regulating Valves	12
2-B: Thermostatic Mixing Valves	12
2-C: Ball Valves & Check Valves	13
<b>SECTION 3: SHARKBITE PEX BARB FITTINGS</b>	<b>13</b>
3-A: PEX Barb Core Fittings	13
3-B: PEX Barb Transition Fittings	15
3-C: PEX Barb Poly Alloy Fittings	16
3-D: PEX Barb Fire Fittings	17
3-E: PEX Barb Stop & Fixture Supply Fittings	17
3-F: PEX Barb Additional Products	17
3-G: PEX Barb Accessories	18
3-H: PEX Barb Tools	19
<b>MADE IN THE USA</b>	<b>20</b>
<b>BENEFITS OF SHARKBITE PEX</b>	<b>21</b>
<b>SECTION 4: SHARKBITE PEX PIPE</b>	<b>22</b>
4-A: Potable Water PEX Pipe	22
4-B: Special Application PEX Pipe	23
<b>LIMITED WARRANTY</b>	<b>24</b>



VISIT US ONLINE OR ON THE GO  
[www.sharkbite.com](http://www.sharkbite.com)

# SHARKBITE

## CONNECTION SYSTEM

### CUT. PUSH. DONE.

The SharkBite Connection System makes any plumbing project fast and easy with our unique push-to-connect technology. When you insert a pipe into the SharkBite quick connect fittings, the stainless steel teeth bite down and grip the pipe, while the specially formulated O-ring compresses to create the perfect watertight seal. No soldering, clamps, unions or glue.

Our product works with your existing plumbing, is easy to disassemble for changing and reusing fittings, and can be rotated for easier installation in tight spaces. Perfect for joining Copper, PEX, CPVC or PE-RT pipe, SharkBite is the no fuss way to fix small leaks or plumb a whole house.

Our proven system includes hundreds of products from dozens of different fittings, a wide range of push-to-connect valves and even our own SharkBite PEX Pipe to make completing a job even easier.

Compatible with many Cash Acme valves, try the SharkBite connection system for your next project and discover just how fast and easy fixing a leak or plumbing a house should be.

[www.sharkbite.com](http://www.sharkbite.com)

***All SharkBite fittings are made of Lead Free DZR brass and exceed ASSE 1061 Section 1V, 4.1 Materials-Dezincification (DZR) - ISO 6509 standards.***



PRODUCT DESCRIPTION		PART NUMBER
<b>SECTION 1: THE SHARKBITE CONNECTION SYSTEM</b>		
<b>1-A: CORE FITTINGS</b>		
<b>COUPLINGS</b>		
1/4" (3/8" OD) X 1/4" (3/8" OD)		U004LF
3/8" (1/2" OD) X 3/8" (1/2" OD)		U006LF
1/2" X 1/2"		U008LF
3/4" X 3/4"		U016LF
1" X 1"		U020LF
<b>2XL</b>	1-1/4" X 1-1/4" (For PEX applications, stiffeners are sold separately)	SB0135
	1-1/2" X 1-1/2" (For PEX applications, stiffeners are sold separately)	SB0141
	2" X 2" (For PEX applications, stiffeners are sold separately)	SB0154
<b>REDUCING COUPLINGS</b>		
1/4" (3/8" OD) X 1/2" Reducing		U050LF
3/8" (1/2" OD) X 1/2" Reducing		U009LF
3/4" X 1/2" Reducing		U058LF
1" X 3/4" Reducing		U060LF
<b>2XL</b>	1-1/4" X 1" Reducing (For PEX applications, stiffeners are sold separately)	SB013528
	1-1/2" X 1" Reducing (For PEX applications, stiffeners are sold separately)	SB014128
	1-1/2" X 1-1/4" Reducing (For PEX applications, stiffeners are sold separately)	SB014135
	2" X 1-1/2" Reducing (For PEX applications, stiffeners are sold separately)	SB015441
<b>SLIP FITTINGS</b>		
SharkBite slip couplings and tees are ideal for repairing and tapping into existing rigid pipe lines. The slip feature ensures the pipe is fully engaged into the fitting when the pipe is in a fixed position. The slip end is only suitable for use with Copper and CPVC pipe.		
<b>SLIP COUPLINGS (SLIP END ONLY SUITABLE FOR COPPER AND CPVC)</b>		
Slip couplings are the most efficient way to repair a burst pipe or leak. Slip fittings simply repair by doing the job that two couplings and extra pipe used to do. Only one end of the coupling has a slip, allowing the opposite end to slide freely over the end of a pipe. The fittings can then be released with a disconnect tool and slid back onto the other end of the pipe for a successful connection and leak repair.		
1/2" X 1/2"		U3008LF
3/4" X 3/4"		U3016LF
1" X 1"		U3020LF
<b>2XL</b>	1-1/4" X 1-1/4"	SB0635
	1-1/2" X 1-1/2"	SB0641
	2" X 2"	SB0654

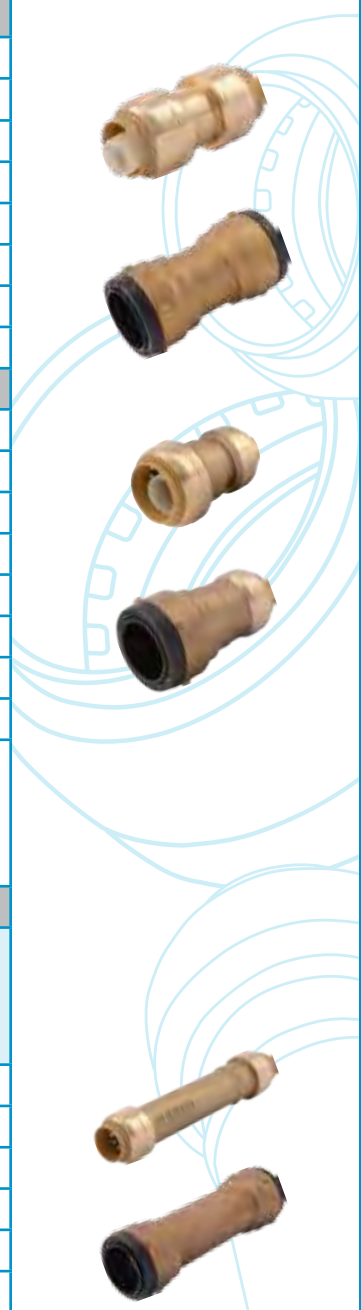

### HOW TO INSTALL SHARKBITE PUSH-TO-CONNECT PRODUCTS



**CUT:**  
Cut the pipe square removing rough edges and debris. Mark the pipe to the correct insertion depth.

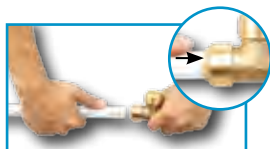

**PUSH:**  
Push pipe and fitting together up to the depth mark.



**DONE.**



\*Using the disconnect clip, fittings can be easily changed, removed and reused.



PRODUCT DESCRIPTION		PART NUMBER
<b>FEMALE CONNECTORS</b>		
1/4" (3/8" OD) X 1/2" FNPT Reducing		U066LF
3/8" (1/2" OD) X 1/2" FNPT Reducing		U070LF
1/2" X 3/4" FNPT Reducing		U068LF
1/2" X 1/2" FNPT Straight		U072LF
3/4" X 3/4" FNPT Straight		U088LF
3/4" X 1/2" FNPT Bullnose		U092LF
1" X 1" FNPT Straight		U094LF
<b>2XL</b>	1-1/4" X 1-1/4" FNPT (For PEX applications, stiffeners are sold separately)	SB113532F
	1-1/2" X 1-1/2" FNPT (For PEX applications, stiffeners are sold separately)	SB114140F
	2" X 2" FNPT (For PEX applications, stiffeners are sold separately)	SB115450F
<b>MALE CONNECTORS</b>		
1/4" X 1/2" MNPT Reducing		U110LF
3/8" (1/2" OD) X 1/2" MNPT Reducing		U118LF
1/2" X 3/4" MNPT Reducing		U116LF
1/2" X 1/2" MNPT Straight		U120LF
3/4" X 3/4" MNPT Straight		U134LF
3/4" X 1/2" MNPT Bullnose		U138LF
3/4" X 1" MNPT Straight		U139LF
1" X 1" MNPT Straight		U140LF
1" X 3/4" MNPT Reducing		U142LF
<b>2XL</b>	1-1/4" X 1-1/4" MNPT (For PEX applications, stiffeners are sold separately)	SB113532M
	1-1/2" X 1-1/2" MNPT (For PEX applications, stiffeners are sold separately)	SB114140M
	2" X 2" MNPT (For PEX applications, stiffeners are sold separately)	SB115450M
<b>THREADED ADAPTERS</b>		
3/4" CTS X 3/4" FNPT Threaded (CTS end inserts into any 3/4" SB fitting)		U766LF
1" CTS X 1" FNPT Threaded (CTS end inserts into any 1" SB fitting)		U772LF
<b>90° ELBOWS</b>		
1/4" (3/8" OD) X 1/4" (3/8" OD)		U244LF
3/8" (1/2" OD) X 3/8" (1/2" OD)		U246LF
1/2" X 1/2"		U248LF
3/4" X 3/4"		U256LF
1" X 1"		U260LF
<b>2XL</b>	1-1/4" X 1-1/4" (For PEX applications, stiffeners are sold separately)	SB0235
	1-1/2" X 1-1/2" (For PEX applications, stiffeners are sold separately)	SB0241
	2" X 2" (For PEX applications, stiffeners are sold separately)	SB0254
<b>45° ELBOWS</b>		
<b>2XL</b>	1-1/4" X 1-1/4" (For PEX applications, stiffeners are sold separately)	SB0535
	1-1/2" X 1-1/2" (For PEX applications, stiffeners are sold separately)	SB0541
	2" X 2" (For PEX applications, stiffeners are sold separately)	SB0554
<b>45° STREET ELBOWS</b>		
<b>2XL</b>	1-1/4" X 1-1/4" (For PEX applications, stiffeners are sold separately)	SB0735
	1-1/2" X 1-1/2" (For PEX applications, stiffeners are sold separately)	SB0741
	2" X 2" (For PEX applications, stiffeners are sold separately)	SB0754

PRODUCT DESCRIPTION		PART NUMBER
<b>FEMALE ELBOWS</b>		
1/2" X 1/2" FNPT		U308LF
3/4" X 3/4" FNPT (Utilizes a U766LF thread adapter)		U314LF
<b>MALE ELBOWS</b>		
1/2" X 1/2" MNPT		U280LF
3/4" X 3/4" MNPT		U286LF
<b>REDUCING ELBOWS</b>		
1/2" X 3/8" (1/2" OD)		U272LF
3/4" X 1/2"		U274LF
1" X 3/4"		U278LF
<b>DROP-EAR ELBOWS</b>		
3/8" (1/2" OD) X 1/2" FNPT Drop Ear		U332LF
1/2" X 1/2" Drop Ear		U249LF
1/2" X 1/2" FNPT Drop Ear		U334LF
3/4" X 3/4" FNPT Drop Ear		U340LF
<b>HY-EAR ELBOWS</b>		
1/2" X 1/2" Hy-Ear		U335LF
<b>DISHWASHER ELBOWS</b>		
1/4" (3/8" OD) X 3/8" MNPT Dishwasher		U276LF
1/4" (3/8" OD) X 3/4" Garden Hose Nut		U2276LF
1/2" X 3/8" MNPT Dishwasher		U281LF
<b>TEES</b>		
1/4" (3/8" OD) X 1/4" (3/8" OD) X 1/4" (3/8" OD)		U358LF
3/8" (1/2" OD) X 3/8" (1/2" OD) X 3/8" (1/2" OD)		U360LF
1/2" X 1/2" X 1/2"		U362LF
3/4" X 3/4" X 3/4"		U370LF
1" X 1" X 1"		U374LF
<b>2XL</b>	1-1/4" X 1-1/4" X 1-1/4" (For PEX applications, stiffeners are sold separately)	SB0835
	1-1/2" X 1-1/2" X 1-1/2" (For PEX applications, stiffeners are sold separately)	SB0841
	2" X 2" X 2" (For PEX applications, stiffeners are sold separately)	SB0854
<b>REDUCING TEES</b>		
3/8" (1/2" OD) X 3/8" (1/2" OD) X 1/2" Reducing		U364LF
1/2" X 1/2" X 1/4" (3/8" OD) Reducing		U359LF
1/2" X 1/2" X 3/8" (1/2" OD) Reducing		U363LF
3/4" X 3/4" X 1/2" Reducing		U412LF
3/4" X 1/2" X 3/4" Reducing		U444LF
3/4" X 1/2" X 1/2" Reducing		U454LF
1" X 1" X 3/4" Reducing		U416LF
<b>2XL</b>	1-1/4" X 1-1/4" X 1/2" Reducing Tee (For PEX applications, stiffeners are sold separately)	SB08353516
	1-1/4" X 1-1/4" X 3/4" Reducing Tee (For PEX applications, stiffeners are sold separately)	SB08353522
	1-1/4" X 1-1/4" X 1" Reducing Tee (For PEX applications, stiffeners are sold separately)	SB08353528
	1-1/2" X 1-1/2" X 3/4" Reducing Tee (For PEX applications, stiffeners are sold separately)	SB08414122
	1-1/2" X 1-1/2" X 1" Reducing Tee (For PEX applications, stiffeners are sold separately)	SB08414128
	1-1/2" X 1-1/2" X 1-1/4" Reducing Tee (For PEX applications, stiffeners are sold separately)	SB08414135





PRODUCT DESCRIPTION		PART NUMBER
<b>2XL</b>	2" X 2" X 1" Reducing Tee (For PEX applications, stiffeners are sold separately)	SB08545428
	2" X 2" X 1-1/4" Reducing Tee (For PEX applications, stiffeners are sold separately)	SB08545435
	2" X 2" X 1-1/2" Reducing Tee (For PEX applications, stiffeners are sold separately)	SB08545441
<b>FEMALE CENTER TEES</b>		
3/4" X 3/4" X 3/4" FNPT		U462LF
1" X 1" X 1" FNPT		U464LF
<b>SLIP TEES (SLIP END ONLY SUITABLE FOR COPPER AND CPVC)</b>		
Slip tees are a great solution for tapping into existing pipe where additional supply lines are needed. Easily add an ice maker or dishwasher line using in conjunction with SharkBite straight and angle stops.		
1/2" X 1/2" X 1/2"		U3362LF
3/4" X 3/4" X 3/4"		U3370LF
<b>2XL</b>	1-1/4" X 1-1/4"	SB0335
	1-1/2" X 1-1/2"	SB0341
	2" X 2"	SB0354
<b>FEMALE CENTER SLIP TEES (SLIP END ONLY SUITABLE FOR COPPER AND CPVC)</b>		
1/2" X 1/2" X 1/2" FNPT Female Center		U3482LF
3/4" X 3/4" X 3/4" FNPT Female Center		U3486LF
<b>SERVICE SLIP TEE ADAPTER (SLIP END ONLY SUITABLE FOR COPPER AND CPVC)</b>		
1/2" X 1/2" X 1/2" CTS Tail Adapter Service Line Tee (CTS end inserts into any 1/2" SB fitting)		U4482LF
<b>REDUCING SLIP TEES (ONLY SUITABLE FOR COPPER AND CPVC-MIDDLE BRANCH MAY BE USED WITH PEX)</b>		
<b>2XL</b>	1-1/4" X 1-1/4" X 1/2" Reducing	SB03353516
	1-1/4" X 1-1/4" X 3/4" Reducing	SB03353522
	1-1/4" X 1-1/4" X 1" Reducing	SB03353528
	1-1/2" X 1-1/2" X 3/4" Reducing	SB03414122
	1-1/2" X 1-1/2" X 1" Reducing	SB03414128
	1-1/2" X 1-1/2" X 1-1/4" Reducing	SB03414135
	2" X 2" X 1" Reducing	SB03545428
	2" X 2" X 1-1/4" Reducing	SB03545435
2" X 2" X 1-1/2" Reducing	SB03545441	
<b>END CAPS</b>		
3/8" (1/2" OD)		U512LF
1/2"		U514LF
3/4"		U518LF
1"		U520LF
<b>2XL</b>	1-1/4" (For PEX applications, stiffeners are sold separately)	SB0435
	1-1/2" (For PEX applications, stiffeners are sold separately)	SB0441
	2" (For PEX applications, stiffeners are sold separately)	SB0454
<b>FITTING REDUCERS (USE TO CONNECT TO SMALLER PIPE SIZES)</b>		
3/8" (1/2" OD) X 1/2" CTS (CTS end inserts into any 1/2" SB fitting)		U719LF
3/8" (1/2" OD) X 3/4" CTS (CTS end inserts into any 3/4" SB fitting)		U721LF
1/2" X 1" CTS (CTS end inserts into any 1" SB fitting)		U722LF
3/4" X 1" CTS (CTS end inserts into any 1" SB fitting)		U724LF
<b>WATER SOFTENER FITTING</b>		
3/4" X 1" FIP		U086LF



PRODUCT DESCRIPTION	PART NUMBER
<b>1-B: RADIANT FITTINGS</b>	
<b>RADIANT FITTINGS (NON-POTABLE WATER APPLICATION)</b>	
Non-potable water application fittings are manufactured with standard DZR brass.	
5/8" X 5/8" Coupling	U012
3/4" X 5/8" Reducing Coupling	U057
5/8" X 3/4" MNPT Reducing Adapter	U126
5/8" X 5/8" Elbow	U252
3/4" X 5/8" Elbow	U273
5/8" X 5/8" X 5/8" Tee	U366
5/8" End Stop	U516

<b>1-C: TRANSITION FITTINGS</b>	
<b>POLYBUTYLENE TRANSITION COUPLINGS</b>	
1/2" PB X 1/2" SB PB Transition Coupling	U4008LF
3/4" PB X 3/4" SB PB Transition Coupling	U4016LF
<b>PVC TRANSITION COUPLINGS</b>	
SharkBite PVC transition fittings connect Copper, PEX, CPVC, or PE-RT pipe to PVC pipe (Sch. 40, 80 and 120) without soldering, clamps, unions, or glue.	
1/2" CTS X 1/2" PVC Transition Coupling	UIP4008
3/4" CTS X 3/4" PVC Transition Coupling	UIP4016
1" CTS X 1" PVC Transition Coupling	UIP4020
<b>PVC TRANSITION SLIP TEES</b>	
1/2" CTS X 1/2" CTS X 1/2" PVC Transition Slip Tee	UIP363
1/2" PVC X 1/2" PVC X 1/2" CTS Transition Slip Tee	UIP364
3/4" CTS X 3/4" CTS X 3/4" PVC Transition Slip Tee	UIP371
3/4" PVC X 3/4" PVC X 3/4" CTS Transition Slip Tee	UIP372
1" CTS X 1" CTS X 1" PVC Transition Slip Tee	UIP375
1" PVC X 1" PVC X 1" CTS Transition Slip Tee	UIP376
<b>PVC SLIP COUPLINGS</b>	
1/2" PVC X 1/2" PVC Slip Repair Coupling	UIP3008
3/4" PVC X 3/4" PVC Slip Repair Coupling	UIP3016
1" PVC X 1" PVC Slip Repair Coupling	UIP3020
<b>PVC MALE CONNECTORS</b>	
1/2" PVC X 1/2" MNPT Male Connector	UIP120
3/4" PVC X 3/4" MNPT Male Connector	UIP134
1" PVC X 1" MNPT Male Connector	UIP140
<b>PVC DEPTH GAUGE AND DISCONNECT CLIPS</b>	
1/2" PVC Depth Gauge and Disconnect Clip	UIP710
3/4" PVC Depth Gauge and Disconnect Clip	UIP712
1" PVC Depth Gauge and Disconnect Clip	UIP714

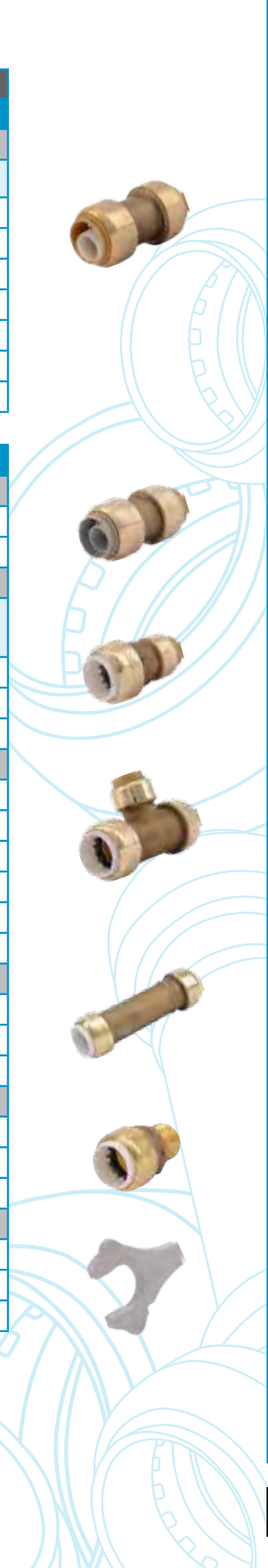



PRODUCT DESCRIPTION	PART NUMBER
<b>1-D: FIRE FITTINGS</b>	
<b>FIRE HORIZONTAL TEES</b>	
3/4" x 3/4" SB x 1/2" FNPT	UF12128H
1" x 3/4" SB x 1/2" FNPT	UF16128H
1" x 1" SB x 1/2" FNPT	UF16168H
<b>FIRE VERTICAL TEES</b>	
3/4" x 3/4" SB x 1" FNPT	UF12128V
1" x 3/4" SB x 1/2" FNPT	UF16128V
1" x 1" SV x 1/2" FNPT	UF16168V
<b>FIRE DROP-EAR ELBOWS</b>	
3/4" SB x 1/2" FNPT	UF128U
1" SB X 1/2" FNPT	UF168U
<b>FIRE THREADED FEMALE ADAPTERS</b>	
3/4" SB X 1/2" FNPT	UF128S
<b>FIRE ANGLED ADAPTERS</b>	
3/4" X 3/4" SB X 1/2" FNPT	UF12128A
<b>FIRE FEMALE ELBOWS</b>	
3/4" SB X 1/2" FNPT Left	UF128L
3/4" SB X 1/2" FNPT Right	UF128R
1" SB X 1/2" FNPT Left	UF168L
1" SB X 1/2" FNPT Right	UF168R

### 1-E: FLEX HOSES

The SharkBite flexible connectors are used in residential and commercial applications to easily connect pipe in any combination. The SharkBite fitting allows the installer to connect to Copper, CPVC and PEX pipe eliminating the need for an additional transition fitting.

#### BRAIDED FLEXIBLE WATER HEATER CONNECTORS

The SharkBite water heater connectors are used in residential and commercial applications to connect the hot and cold supply lines to the water heater. The connectors are available in 12", 15", 18" and 24" lengths (with and without ball valve).

1/2" X 3/4" FIP, 12" Stainless Steel Braided Water Heater Connector	U3068FLEX12LF
1/2" X 3/4" FIP, 15" Stainless Steel Braided Water Heater Connector	U3068FLEX15LF
1/2" X 3/4" FIP, 18" Stainless Steel Braided Water Heater Connector	U3068FLEX18LF
1/2" X 3/4" FIP, 24" Stainless Steel Braided Water Heater Connector	U3068FLEX24LF
3/4" X 3/4" FIP, 12" Stainless Steel Braided Water Heater Connector	U3088FLEX12LF
3/4" X 3/4" FIP, 15" Stainless Steel Braided Water Heater Connector	U3088FLEX15LF
3/4" X 3/4" FIP, 18" Stainless Steel Braided Water Heater Connector	U3088FLEX18LF
3/4" X 3/4" FIP, 24" Stainless Steel Braided Water Heater Connector	U3088FLEX24LF
<b>CORRUGATED STAINLESS STEEL WATER HEATER CONNECTORS</b>	
3/4" X 3/4" FIP, 18" Stainless Steel Corrugated Water Heater Connector	SS3088FLEX18LF
3/4" X 3/4" FIP, 24" Stainless Steel Corrugated Water Heater Connector	SS3088FLEX24LF
3/4" x 1" FIP, 24" Stainless Steel Corrugated Water Heater Connector	SS3086FLEX24LF
<b>BRAIDED FLEXIBLE WATER HEATER CONNECTORS WITH BALL VALVES</b>	
1/2" X 3/4" FIP, 18" Stainless Steel Braided Water Heater Connector with Ball Valve	U3068FLEX18BVLV
3/4" X 3/4" FIP, 18" Stainless Steel Braided Water Heater Connector with Ball Valve	U3088FLEX18BVLV



PRODUCT DESCRIPTION	PART NUMBER
<b>CORRUGATED STAINLESS STEEL WATER HEATER CONNECTORS WITH BALL VALVES</b>	
1/2" X 3/4" FIP, 18" Stainless Steel Corrugated Water Heater Connector with Ball Valve	SS3068FLEX18BV
3/4" X 3/4" FIP, 18" Stainless Steel Corrugated Water Heater Connector with Ball Valve	SS3088FLEX18BV
<b>BRAIDED FLEXIBLE COUPLING HOSES</b>	
1/2" X 1/2", 18"	U3008FLEX18LF
3/4" X 3/4", 18"	U3016FLEX18LF
<b>BRAIDED WATER SOFTENER HOSES</b>	
The SharkBite water softener hose can be used for connection of new water softeners or replacement of existing connectors. The 3/4" SharkBite x 1" FIP swivel nut connectors makes for quick and easy installation.	
3/4" X 1" FIP, 24"	U3086FLEX24LF



## 1-F: STOPS & FIXTURE SUPPLY FITTINGS

Connecting supply lines to fixtures and appliances using these new SharkBite products brings the speed and convenience of push-to-connect connections to the final phase of your plumbing jobs. Regular and chrome plated fittings are now available, including the newest 1/2" X 1/4" (3/8" OD) SharkBite stop valves. Stops in 1/2" X 3/8" or 1/4" compression sizes are also available. With these new SharkBite push-to-connect fittings, stop valves and the 5' lengths or 50' coils of 1/4" (3/8" OD) PEX pipe, it's easy to make risers the exact length needed for connecting fixtures and appliances. No more problems with flexible lines that are too long or too short.

<b>ANGLE STOPS</b>	
1/2" X 3/8" Compression Angle Stop	23036-0000LF
1/2" X 3/8" Compression Loose Key	24731LF
1/2" X 1/4" (3/8" OD) Angle Stop	23048-0000LF
1/2" X 1/4" (3/8" OD) Loose Key	24733LF
1/2" X 1/4" Compression Angle Stop	23336-0000LF
1/2" X 1/2" Compression Angle Stop	23489
1/2" x 1/2" MIP Angle Stop	24946
<b>STRAIGHT STOPS</b>	
1/2" X 3/8" Compression Straight Stop	23037-0000LF
1/2" X 3/8" Compression Loose Key	24732LF
1/2" X 1/4" (3/8" OD) Straight Stop	23049-0000LF
1/2" X 1/4" (3/8" OD) Loose Key	24734LF
1/2" X 1/4" Compression Straight Stop	23337-0000LF
1/2" X 1/2" Compression Straight Stop	23490
1/2" x 1/2" MIP Straight Stop	24947
<b>TEE STOPS</b>	
1/2" X 1/2" X 1/4" Compression	24983
1/2" X 1/2" X 3/8" Compression	24984
3/4" X 3/4" X 1/4" Compression	24985
3/4" X 3/4" X 3/8" Compression	24986
1/2" X 1/2" X 1/4" (3/8" OD) SB	24987
<b>DUAL TEE STOP VALVE ADAPTERS</b>	
Insert onto stub-out then fit any of the eight SharkBite stop valves to create any combination desired.	
1/2" CTS X 1/2" CTS X 1/2" Dual Tee Stop Valve Adapter (CTS ends insert into any 1/2" SB fitting. Recommended use with Angle/Straight Stops.)	U782LF
<b>STOP VALVE CONNECTORS</b>	
1/4" (3/8" OD) X 3/8" Compression Stop Valve Connector (Converts 3/8" comp stop to SharkBite)	U3523LF
1/4" (3/8" OD) X 1/4" Compression Nut	U3524LF





PRODUCT DESCRIPTION	PART NUMBER
<b>STOP VALVE TEE ADAPTERS</b>	
1/4" (3/8" OD) X 1/4" (3/8" OD) X 3/8" Compression Stop Valve Tee Adaptor	U3358LF
1/4" (3/8" OD) X 1/4" (3/8" OD) X 1/4" (3/8" OD) Tube Stop Valve Tee Adapter	U4358LF
<b>FAUCET CONNECTORS</b>	
1/4" (3/8" OD) X 1/2" Threaded Faucet Connector	U3525LF
<b>TOILET CONNECTORS</b>	
1/4" (3/8" OD) X 7/8" Ballcock Threads Toilet Connector	U3531LF
1/4" (3/8" OD) X 7/8" Ballcock Threads Toilet Elbow	U3537LF



1-G: ADDITIONAL PRODUCTS	
<b>MANIFOLDS WITH PUSH-TO-CONNECT BRANCHES</b>	
Manifolds are traditionally used in PEX systems, but this SharkBite manifold will also allow for easy incorporation into Copper or CPVC systems. Use SharkBite push-to-connect fittings to install these manifolds anywhere in a plumbing system. All manifolds have a 1" trunk with 3/4" tube inlets and outlets and 1/2" push-to-connect ports (2" on center).	
3 Port - Open 1" trunk, 3/4" X 3/4", 3 - 1/2" branches 2" on center	22995LF
3 Port - Closed 1" trunk, 3/4" X Spun Closed, 3 - 1/2" branches 2" on center	22996LF
4 Port - Open 1" trunk, 3/4" X 3/4", 4 - 1/2" branches 2" on center	22997LF
4 Port - Closed 1" trunk, 3/4" X Spun Closed, 4 - 1/2" branches 2" on center	22998LF



<b>WATER HAMMER ARRESTORS</b>	
Provides maintenance free, continuous protection against water hammer. The arrestor can be positioned vertically or horizontally and the SharkBite connectors allow the arrestor to be installed in seconds, even on wet pipe.	
1/2" Residential	22630LF
1/2" Commercial	22631LF
3/4" Residential	22632LF
1" Commercial	22633LF



<b>STUB OUT ELBOWS</b>	
The SharkBite stub-out elbows come with pre-fitted mounting brackets that provide four fixed installation positions on all wooden surfaces (studs, joists and subfloors) by simply rotating or repositioning the mounting bracket.	
1/2" SB X 1/2" Copper Tube 8" Length	U351LFA



<b>PRESSURE GAUGES</b>	
1/2" SB Tee with Pressure Gauge	24436
3/4" SB Tee with Pressure Gauge	24438
1" SB Tee with Pressure Gauge	24440
1/2" CTS Pressure Gauge (inserts into any 1/2" SB fitting)	24442
3/4" CTS Pressure Gauge (inserts into any 3/4" SB fitting)	24444



<b>TEMPERATURE GAUGES</b>	
1/2" SB Tee with Temperature Gauge	24437
3/4" SB Tee with Temperature Gauge	24439
1" SB Tee with Temperature Gauge	24441
1/2" CTS Temperature Gauge (inserts into any 1/2" SB fitting)	24443
3/4" CTS Temperature Gauge (inserts into any 3/4" SB fitting)	24445



1-H: KITS	
<b>WATER HEATER INSTALLATION KITS (KITS INCLUDE 2 SHARKBITE CONNECTOR FITTINGS AND A DISCONNECT CLIP)</b>	
1/2" X 3/4" FNPT	22604LF
3/4" X 3/4" FNPT	22441LF

PRODUCT DESCRIPTION	PART NUMBER
<b>CONTRACTOR KITS (KIT INCLUDES TOOLBOX)</b>	
These SharkBite kits include a variety of push-to-connect fittings, disconnect tongs and clips, and a sturdy case for storage and transport.	
Contractor Kit: 2 each (U008LF, U016LF, U058LF, U072LF, U088LF, U120LF, U134LF, U248LF, U256LF) and 1 each (U362LF, U370LF, U514LF, U518LF, U710, U711, U713 and U702)	22486LF
Contractor Kit: 2 each (U008LF, U016LF) and 1 each (U3008LF, U3016LF, UIP4016LF, U514LF, U518LF, 24983, 24736LF U702, UIP712, U712, U711, U713)	25404
Contractor Tool Box Only	U3001A
<b>FAUCET KIT IN BAGGED PACKAGING (FAUCET KITS COME WITH 2 FAUCET CONNECTORS, 2 ANGLE STOPS, AND 1 COIL OF 10' 1/4" WHITE PEX PIPE)</b>	
Faucet Connector with Angle Stop	25087
<b>TOILET KIT IN BAGGED PACKAGING (TOILET KITS COME WITH 1 TOILET CONNECTOR, 1 ANGLE STOP, AND 1 COIL OF 5' 1/4" WHITE PEX PIPE.)</b>	
Toilet Connector with Angle Stop	25088
<b>ICE MAKER KIT IN BAGGED PACKAGING (ICE MAKER KITS COME WITH 1 SERVICE SLIP TEE, 1 ANGLE STOP, 1 VALVE CONNECTOR, 10' 1/4" WHITE PEX PIPE)</b>	
Ice Maker Connector with Angle Stop	25024
<b>ICE MAKER OUTLET BOX KIT</b>	
1/2" SB X 1/8" Compression Ice Maker Outlet Box	25096
1/2" SB X 1/8" Compression Ice Maker Outlet Box With Water Hammer Arrestor	25097
<b>WASHING MACHINE OUTLET BOX KIT</b>	
1/2" SB X 3/4" MHT Washing Machine Outlet Box	25098
1/2" SB X 3/4" MHT Washing Machine Outlet Box With Water Hammer Arrestor	25099

1-I: TOOLS		
<b>DEBURR &amp; GAUGE TOOLS</b>		
Deburr and Gauge Tool (Use for 1/4", 3/8", 1/2", 5/8", 3/4" and 1" copper and CPVC pipe)		U702
<b>2XL</b>	1-1/4", 1-1/2", 2" Deburr and Gauge Tool	SBG03
<b>DISCONNECT CLIPS</b>		
1/4" Disconnect Clip		U706
3/8" Disconnect Clip		U708
1/2" Disconnect Clip		U710
5/8" Disconnect Clip		U3712
3/4" Disconnect Clip		U712
1" Disconnect Clip		U714
<b>DISCONNECT TONGS</b>		
1/2" Disconnect Tong		U711
3/4" Disconnect Tong		U713
1" Disconnect Tong		U715
<b>DE-MOUNT CLIPS</b>		
<b>2XL</b>	1-1/4" De-Mount Clip	SBDC35
	1-1/2" De-Mount Clip	SBDC41
	2" De-Mount Clip	SBDC54
	1-1/4", 1-1/2", 2" De-Mount Clip Set	SBDC354154

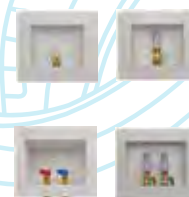



PRODUCT DESCRIPTION		PART NUMBER
<b>LARGE DIAMETER PEX STIFFENERS</b>		
<b>2XL</b>	1-1/4" PEX Stiffener	SBTL35
	1-1/2" PEX Stiffener	SBTL41
	2" PEX Stiffener	SBTL54
<b>WRAP FOR FITTING BURIAL</b>		
10' x 2" X 0.02" Silicone Wrap		25406

## SECTION 2: SHARKBITE VALVES

### 2-A: PRESSURE REGULATING VALVES

The innovative, labor reducing EB45 and the EB25 pressure regulating valves are available with double union and direct SharkBite connectors. The EB45 is factory set at 45 or 60 psi and is adjustable to 10-70 psi. The EB25 is set at 45 psi and features a twist cap with a numerical pressure indicator for easy one-man adjustment.

#### EB45 LEAD FREE SHARKBITE CONNECTIONS (ALL EB45 VALVES FACTORY SET AT 45 PSI UNLESS SPECIFIED)

1/2" EB45-DSB Direct SharkBite	23807-0045
1/2" EB45-SDSB Slip Feature Direct SharkBite	24383-0045
1/2" EB45-DUSB Double Union SharkBite	23893-0045
3/4" EB45-DSB Direct SharkBite	23808-0045
3/4" EB45-SDSB Slip Feature Direct SharkBite	24384-0045
3/4" EB45-DUSB Double Union SharkBite	23894-0045
3/4" EB45-DUSB Double Union SharkBite (60 psi Setting)	23896-0060
3/4" EB45-DUSB Double Union SharkBite with Gauge Port	24449-0045
1" EB45-DSB Direct SharkBite	22675-0045
1" EB45-DUSB Double Union SharkBite	23358-0045
1" EB45-DUSB Double Union SharkBite (60 psi Setting)	23945-0060

#### EB25 LEAD FREE SHARKBITE CONNECTIONS

3/4" EB25-DUSB Double Union SharkBite	23955-0045
1" EB25-DUSB Double Union SharkBite	23956-0045

### 2-B: THERMOSTATIC MIXING VALVES

Direct or double union SharkBite push-to-connect connectors provide a simplified, time and labor saving installation. Heatguard<sup>®</sup> valves deliver water at a safe 120°F (49°C) or lower from all outlets, while allowing the thermostat to be set at a germ-killing 140°F (60°C) or higher which aids in preventing the growth of legionella bacteria in the water heater. The higher tank temperature means hot water demands can be satisfied longer. Every valve is tested for performance and includes a unique adjuster tool that minimizes tampering with the valve setting. Rugged, simple construction incorporates a precise engineered polymer piston and the latest in thermostatic technology.

#### HG110-D LEAD FREE (ASSE 1017, 1069, & 1070, CSA B 125.3. DISTRIBUTION AND IN-LINE)

1/2" HG110-D with SharkBite Connections	24504
3/4" HG110-D with SharkBite Connections	24505

#### HG160 LEAD FREE (ASSE 1069 & 1070, CSA B 125.3. IN-LINE)

1/2" HG160 with SharkBite Connections	24529
3/4" HG160 with SharkBite Connections	24530



PRODUCT DESCRIPTION		PART NUMBER
<b>2-C: BALL VALVES &amp; CHECK VALVES</b>		
<b>BALL VALVES</b>		
1/2" X 1/2"		22222-0000LF
3/4" X 3/4"		22185-0000LF
1" X 1"		22223-0000LF
1/2" SharkBite X 1/2" FNPT		22182-0000LF
3/4" SharkBite X 3/4" FNPT		22186-0000LF
1" SharkBite X 1" FNPT		22187-0000LF
<b>2XL</b>	SharkBite 1-1/4" Ball Valve	SBBV35
	SharkBite 1-1/2" Ball Valve	SBBV41
	SharkBite 2" Ball Valve	SBBV54
<b>BALL VALVES WITH DRAIN / VENT</b>		
1/2" with Drain		22304-0000LF
3/4" with Drain		22305-0000LF
1" with Drain		22306-0000LF
<b>SLIP BALL VALVE (ONLY SUITABLE FOR COPPER AND CPVC)</b>		
1/2"		24735LF
3/4"		24736LF
1"		24737LF
<b>CHECK VALVES</b>		
1/2" X 1/2"		U2008-0000LF
3/4" X 3/4"		U2016-0000LF
1" X 1"		U2020-0000LF



SECTION 2: SHARKBITE VALVES

<b>SECTION 3: SHARKBITE PEX BARB FITTINGS</b>		
<b>3-A: PEX BARB CORE FITTINGS</b>		
<p>The SharkBite PEX/Barb Connection System is the best option for connecting PEX pipe in water distribution systems when lower material cost is desired. Robustly constructed with Lead Free DZR brass, the SharkBite barb fittings are corrosion resistant. With a wide range of fittings, manifolds, valves, clamp rings, crimp rings, ball valves and tools available, the SharkBite PEX/Barb Connection System is perfect for your next plumbing project.</p>		
<b>COUPLINGS BULK PACKAGED</b>		
3/8"		UC006LF
1/2"		UC008LF
5/8"		UC012LF
3/4"		UC016LF
1"		UC020LF
<b>REDUCING COUPLINGS BULK PACKAGED</b>		
3/8" X 1/2" Reducing		UC009LF
1/2" X 3/4" Reducing		UC058LF
3/4" X 5/8" Reducing		UC057LF
3/4" X 1" Reducing		UC060LF
<b>THREADED FEMALE ADAPTERS BULK PACKAGED</b>		
1/2" X 3/4" FNPT		UC068LF
1/2" X 1/2" FNPT		UC072LF



SECTION 3: SHARKBITE PEX BARB FITTINGS



PRODUCT DESCRIPTION	PART NUMBER
3/4" X 3/4" FNPT	UC088LF
1" X 1" FNPT	UC094LF
<b>THREADED MALE ADAPTERS BULK PACKAGED</b>	
1/2" X 3/4" MNPT	UC116LF
3/8" X 1/2" MNPT	UC118LF
1/2" X 1/2" MNPT	UC120LF
3/4" X 3/4" MNPT	UC134LF
3/4" X 1/2" MNPT	UC138LF
3/4" X 1" MNPT	UC139LF
1" X 1" MNPT	UC140LF
1" X 3/4" MNPT	UC142LF
<b>SWEAT FEMALE ADAPTERS BULK PACKAGED</b>	
1/2" X 1/2" Female Sweat Adapter	UC600LF
3/4" X 3/4" Female Sweat Adapter	UC606LF
1" X 1" Female Sweat Adapter	UC605LF
<b>SWEAT MALE ADAPTERS BULK PACKAGED</b>	
1/2" X 1/2" Male Sweat Adapter	UC607LF
3/4" X 3/4" Male Sweat Adapter	UC608LF
1" X 1" Male Sweat Adapter	UC609LF
<b>ELBOWS BULK PACKAGED</b>	
3/8" X 3/8"	UC246LF
1/2" X 1/2"	UC248LF
3/4" X 3/4"	UC256LF
1" X 1"	UC260LF
<b>REDUCING ELBOWS BULK PACKAGED</b>	
1/2" X 3/8"	UC272LF
1/2" X 3/4"	UC274LF
3/4" X 5/8"	UC273LF
<b>DROP-EAR ELBOWS BULK PACKAGED</b>	
1/2" X 1/2" FNPT Drop Ear	UC334LF
3/4" X 3/4" FNPT Drop Ear	UC340LF
3/4" X 1/2" FNPT Drop Ear	UC342LF
<b>ADAPTER ELBOWS BULK PACKAGED</b>	
1/2" X 1/2" MNPT	UC280LF
1/2" X 3/4" MNPT	UC278LF
3/4" X 3/4" MNPT	UC286LF
3/4" X 3/4" Female Sweat	UC626LF
3/4" X 3/4" Male Sweat	UC628LF
<b>TEES BULK PACKAGED</b>	
3/8" X 3/8" X 3/8"	UC360LF
1/2" X 1/2" X 1/2"	UC362LF
3/4" X 3/4" X 3/4"	UC370LF
1" X 1" X 1"	UC374LF



PRODUCT DESCRIPTION	PART NUMBER
<b>BULLNOSE TEES BULK PACKAGED</b>	
1/2" X 1/2" X 3/4" Bull Nose	UC408LF
3/4" X 3/4" X 1" Bull Nose	UC413LF
<b>REDUCING TEES BULK PACKAGED</b>	
3/8" X 3/8" X 1/2" Reducing	UC364LF
1/2" X 3/8" X 3/8" Reducing	UC452LF
1/2" X 1/2" X 3/8" Reducing	UC363LF
1/2" X 3/8" X 1/2" Reducing	UC434LF
3/4" X 3/4" X 3/8" Reducing	UC417LF
3/4" X 3/4" X 1/2" Reducing	UC412LF
3/4" X 1/2" X 1/2" Reducing	UC454LF
3/4" X 1/2" X 3/4" Reducing	UC444LF
1" X 3/4" X 3/4" Reducing	UC414LF
1" X 1" X 1/2" Reducing	UC415LF
1" X 1" X 3/4" Reducing	UC416LF
1" X 3/4" X 1" Reducing	UC418LF
<b>SWIVEL ADAPTERS BULK PACKAGED</b>	
3/8" X 3/8" FNPT Swivel Adapter	UC527LF
1/2" X 1/2" FNPT Swivel Adapter	UC526LF
1/2" X 3/4" FNPT Swivel Adapter	UC534LF
3/4" X 3/4" FNPT Swivel Adapter	UC530LF
3/4" X 1" Swivel Adapter	UC529LF
1" X 1" FNPT Swivel Adapter	UC594LF
<b>SWIVEL ELBOWS BULK PACKAGED</b>	
3/8" X 1/2" MNPT Swivel Elbow	UC531LF
1/2" X 1/2" FNPT Swivel Elbow	UC532LF
<b>SWIVEL TOILET CONNECTION ELBOWS BULK PACKAGED</b>	
1/2" X 7/8" Straight Swivel Toilet Connectors	UC528LF
3/8" X 7/8" Elbow Swivel Toilet Connectors	23068LF
1/2" X 7/8" Elbow Swivel Toilet Connectors	23067LF
<b>PLUGS BULK PACKAGED</b>	
3/8"	UC512LF
1/2"	UC514LF
3/4"	UC518LF
1"	UC520LF

<b>3-B: PEX BARB TRANSITION FITTINGS</b>	
<b>POLYBUTYLENE TRANSITION FITTINGS BULK PACKAGED (WITH PB CRIMP RING)</b>	
3/8" PB Coupling	UC4006LF
1/2" PB Coupling	UC4008LF
3/4" PB Coupling	UC4016LF





PRODUCT DESCRIPTION	PART NUMBER
<b>3-C: PEX BARB POLY ALLOY FITTINGS</b>	
The SharkBite PEX poly alloy fittings range is an advanced plumbing solution when corrosion may effect DZR brass products.	
<b>COUPLINGS BULK PACKAGED</b>	
1/2" Straight Coupling	UP008
3/4" Straight Coupling	UP016
1" Straight Coupling	UP020
<b>REDUCING COUPLINGS BULK PACKAGED</b>	
3/4" X 1/2" Reducing Coupling	UP058
1" X 3/4" Reducing Coupling	UP060
<b>CONNECTORS BULK PACKAGED</b>	
1/2" X 1/2" MNPT Straight Connector	UP120
3/4" X 3/4" MNPT Straight Connector	UP134
1" X 1" MNPT Straight Connector	UP140
<b>REDUCING CONNECTORS BULK PACKAGED</b>	
3/4" X 1/2" MNPT Reducing Connector	UP138
<b>ELBOWS BULK PACKAGED</b>	
1/2" Elbow	UP248
3/4" Elbow	UP256
1" Elbow	UP260
<b>MALE ELBOWS BULK PACKAGED</b>	
1/2" X 1/2" MNPT Elbow	UP280
<b>REDUCING ELBOWS BULK PACKAGED</b>	
3/4" X 1/2" Elbow	UP274
<b>TEES BULK PACKAGED</b>	
3/8" Tee	UP360
1/2" Tee	UP362
3/4" Tee	UP370
1" Tee	UP374
<b>REDUCING TEES BULK PACKAGED</b>	
1/2" X 1/2" X 3/4" Tee	UP408
3/4" X 3/4" X 1/2" Tee	UP412
3/4" X 1/2" X 3/4" Tee	UP444
3/4" X 1/2" X 1/2" Tee	UP454
1" X 3/4" X 3/4" Tee	UP414
1" X 1" X 1/2" Tee	UP415
1" X 1" X 3/4" Tee	UP416
<b>PLUGS BULK PACKAGED</b>	
1/2" Plug	UP514
3/4" Plug	UP518
1" Plug	UP520
<b>ADAPTERS BULK PACKAGED</b>	
1/2" Female Swivel Adapter	UP526
3/8" Female Swivel Adapter	UP527
1/2" X 1/2" Swivel Elbow Adapter	UP532

PRODUCT DESCRIPTION	PART NUMBER
<b>3-D: PEX BARB FIRE FITTINGS</b>	
<b>FIRE HORIZONTAL TEES</b>	
3/4" x 3/4" SB x 1/2" FNPT	UCF12128H
1" x 3/4" SB x 1/2" FNPT	UCF16128H
1" x 1" SB x 1/2" FNPT	UCF16168H
<b>FIRE VERTICAL TEES</b>	
3/4" x 3/4" SB x 1" FNPT	UCF12128V
1" x 3/4" SB x 1/2" FNPT	UCF16128V
1" x 1" SV x 1/2" FNPT	UCF16168V
<b>FIRE DROP-EAR ELBOWS</b>	
3/4" SB x 1/2" FNPT	UCF128U
1" SB X 1/2" FNPT	UCF168U
<b>FIRE THREADED FEMALE ADAPTERS</b>	
3/4" SB X 1/2" FNPT	UCF128S
<b>FIRE ANGLED ADAPTERS</b>	
3/4" X 3/4" SB X 1/2" FNPT	UCF12128A
<b>FIRE FEMALE ELBOWS</b>	
3/4" SB X 1/2" FNPT Left	UCF128L
3/4" SB X 1/2" FNPT Right	UCF128R
1" SB X 1/2" FNPT Left	UCF168L
1" SB X 1/2" FNPT Right	UCF168R

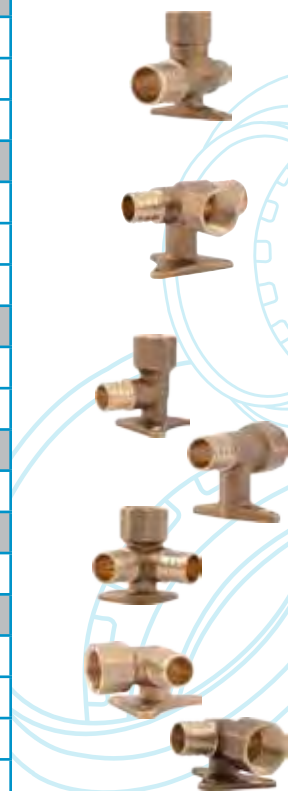

<b>3-E: PEX BARB STOP &amp; FIXTURE SUPPLY FITTINGS</b>	
<b>PEX CHROME PLATED 1/4 TURN ANGLE STOPS</b>	
1/2" X 3/8" OD Compression Angle Stop (Quarter Turn)	23058LF
1/2" X 1/4" OD Compression Angle Stop (Quarter Turn)	23056LF
<b>PEX CHROME PLATED 1/4 TURN STRAIGHT STOPS</b>	
3/8" X 3/8" Straight Stop (Quarter Turn)	23382LF
1/2" X 3/8" OD Compression Straight Stop (Quarter Turn)	23057LF
<b>PEX CHROME PLATED STRAIGHT STOPS</b>	
1/2" X 3/8" Compression Straight Stop	23059LF
1/2" X 3/8" Straight Stop	23062LF
1/2" X 1/2" MPT Straight Stop	23061LF
1/2" X 1/2" Straight Stop	23063LF
<b>PEX CHROME PLATED ANGLE STOPS</b>	
1/2" X 3/8" Compression Angle Stop	23060LF
1/2" X 3/4" MHT Angle Stop	23064LF



<b>3-F: PEX BARB ADDITIONAL PRODUCTS</b>	
<b>COPPER STUBOUT ELBOWS BULK PACKAGED (ALL COPPER STUBOUT ELBOWS ARE LEAD FREE)</b>	
1/2" X Closed (4" X 8")	22791
3/8" X 1/2" (4" X 4")	23069
1/2" X 1/2" (4" X 4")	23070





PRODUCT DESCRIPTION	PART NUMBER
<b>COPPER MANIFOLDS WITH BARB BRANCHES (1" TRUNK WITH 3/4" BARB INLETS &amp; OUTLETS AND 1/2" BARB PORTS - 2" ON CENTER) LEAD FREE</b>	
3 Port Closed	22783
3 Port Open	22784
4 Port Closed	22785
4 Port Open	22786
6 Port Closed	22787
6 Port Open	22788
8 Port Closed	22789
8 Port Open	22790
<b>WATER HAMMER ARRESTORS</b>	
Provides maintenance free, continuous protection against water hammer. The arrestor can be positioned vertically or horizontally.	
1/2" Residential	25401
<b>BARB MANIFOLDS WITH BALL VALVES LEAD FREE</b>	
Manifold 16 Port with Ball Valves	RM22716
Manifold 20 Port with Ball Valves	RM22720
Manifold 24 Port with Ball Valves	RM22724
<b>BARB BALL VALVES BULK PACKAGED</b>	
1/2"	22461LF
3/4"	22462LF
1"	22463LF

3-G: PEX BARB ACCESSORIES	
<b>CLAMP RINGS BULK PACKAGED (STAINLESS STEEL)</b>	
3/8"	UC952
1/2"	UC953
5/8"	UC954
3/4"	UC955
1"	UC956
<b>CRIMP RINGS (COPPER)</b>	
3/8" (25 Pack)	23101CP25
3/8" (100 Pack)	23101CP100
1/2" (25 Pack)	23102CP25
1/2" (100 Pack)	23102CP100
3/4" (25 Pack)	23103CP25
3/4" (100 Pack)	23103CP100
1" (25 Pack)	23104CP25
<b>CRIMP RINGS BULK PACKAGED (COPPER)</b>	
3/8"	23101
1/2"	23102
3/4"	23103
1"	23104

PRODUCT DESCRIPTION	PART NUMBER
<b>PEX BEND SUPPORTS, SUSPENSION CLAMPS AND INSULATORS</b>	
3/8" J Hook Pex Pipe Clamp (10 Pack)	23065
1/2" J Hook Pex Pipe Clamp (10 Pack)	23220
3/4" J Hook Pex Pipe Clamp (10 Pack)	23221
1/2" Insulated Suspension Clamp (10 Pack)	23071A10
3/4" Insulated Suspension Clamp (10 Pack)	23072A10
1" Insulated Suspension Clamp (10 Pack)	23073A10
1/2" Pipe Insulator (10 Pack)	23074A10
3/4" Pipe Insulator (10 Pack)	23075A10
1" Pipe Insulator (10 Pack)	23076A10
1/2" Polymer Bend Support with mounting bracket	23050
3/4" Polymer Bend Support	23051
1/2" Metal Pipe Support	23053
3/4" Metal Pipe Support	23054

### 3-H: PEX BARB TOOLS

SharkBite PEX/Barb tools provide everything needed to ensure a dependable trouble-free installation or repair of PEX/Barb Connection Systems. From our PEX crimp tool to our plastic pipe cutters, our line of rugged tools offer everything needed to cut, secure or remove PEX pipe.

<b>PEX CRIMP TOOLS</b>	
1/2", 3/4" PEX Combo Crimp Tool	23251
3/8", 1/2", 3/4" PEX Pocket Crimp Tool	23383
<b>PEX CRIMP TOOL KIT</b>	
3/8", 1/2", 3/4", 1" PEX Crimp Ring Tool Kit (Crimp Ring Gauge included)	23100
<b>PEX CLAMP TOOLS</b>	
PEX Clamp Tool One-hand Operation	UC961
PEX Clamp Tool Standard Handles	23081
<b>PEX PIPE CUTTER</b>	
PEX Pipe Cutter	U701
<b>CRIMP RING GAUGE</b>	
3/8", 1/2", 3/4", 1" PEX Crimp Ring Gauge	23080
<b>CRIMP RING REMOVAL TOOL</b>	
PEX Crimp Ring Removal Tool	23055
<b>PEX DECOILER</b>	
PEX Decoiler	UFH034



### HOW TO INSTALL SHARKBITE PEX BARB PRODUCTS



#### CUT:

Cut the pipe square removing rough edges and debris.



#### SET:

Slide the ring over the pipe and insert the fitting. Make sure the ring is 1/8" - 1/4" from the edge of the pipe.

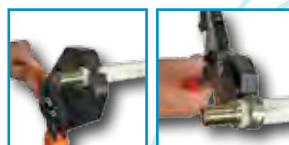

#### PRESS:

Apply pressure to secure the ring over the pipe and fitting.



#### DONE.

# MADE IN THE USA

SharkBite PEX Pipe is a cost effective piping solution approved for use in both hot and cold plumbing installations. Meeting the highest chlorine resistance standards and utilizing the most energy efficient manufacturing processes, our PEX pipe is proudly produced in Alabama. We own our manufacturing process from start to finish, so every piece of SharkBite PEX Pipe is guaranteed from concept to delivery.

PEX pipe was introduced to North America in 1984 based on European market success, and was tested extensively for durability and material performance. All USA-installed PEX pipe must meet the qualification requirements as specified in the ASTM PEX Standards. SharkBite PEX Pipe can bend up to six times the outside diameter of the pipe—which is the maximum bend radius recommended by PEX pipe manufacturers.

SharkBite PEX Pipe can be used in a variety of applications including:

- Domestic plumbing
- Fire suppression systems (residential fire sprinklers)
- Municipal water service pipe for use in underground applications
- Radiant heating systems for suspended floor systems or in slab construction
- Snow and ice melt systems for sidewalks, driveways, entrances, and ramps
- Turf conditioning for greenhouses, golf courses, and sports fields
- Water reuse and reclamations systems

**DISCOVER THE FLEXIBILITY OF SHARKBITE PEX PIPE.**

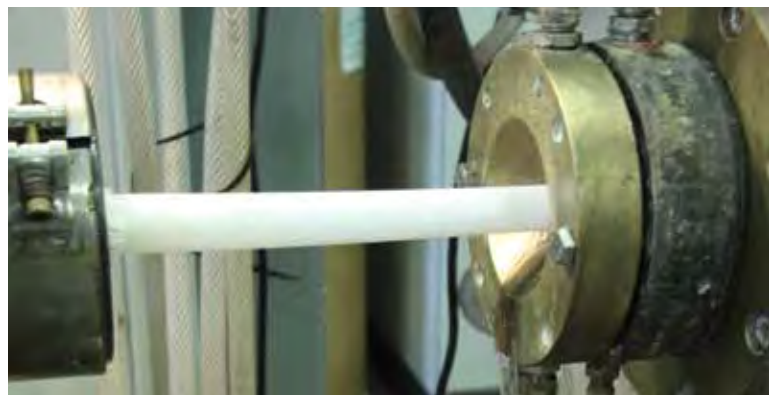

# BENEFITS OF SHARKBITE® PEX



## HEALTH/SAFETY

No glue, solder, or solvents required for the connection process, which keeps potentially dangerous chemicals out of plumbing systems. Additionally, SharkBite PEX Pipe eliminates the need for open flames in the house that could be a potential fire hazard. There is no risk of copper traces in water from breakdown of pipe that has been linked to heart disease and Alzheimer's.



## VERSATILE

SharkBite PEX Pipe can be installed in dry or wet conditions. SharkBite PEX Pipe can lend itself to many applications due to its physical properties of flexibility, reliability and installation ease such as hydronic heating, fire protection, etc.



## CHLORINE RESISTANCE

SharkBite PEX Pipe is tested to the highest level of chlorine resistance standards, testing at 100% chlorine at 140°F.



## PROVEN AND GUARANTEED

SharkBite PEX Pipe has been around for more than 35 years with over 12 Billion feet of pipe installed worldwide.



## FREEZE RESISTANT

SharkBite PEX Pipe is freeze resistant as the pipe can expand and contract as water freezes and thaws within the pipe.



## FLEXIBILITY

Able to bend pipe around corners which removes the need for 45° or 90° elbows in certain situations. SharkBite's new coiling process increases the flexibility of our coiled pipe even more.



## COST EFFECTIVE

SharkBite PEX Pipe is substantially more cost effective than Copper pipe—SharkBite PEX Pipe costs a third of the price of Copper. SharkBite PEX Pipe is a fixed cost as prices don't fluctuate daily like Copper pipe.



## SHARKBITE PEX CERTIFICATIONS



NSF 14/61



ASTM F 877



AWWA C904



ASTM F 876



CSA B137.5



UL 1821

PRODUCT DESCRIPTION	PART NUMBER	PART NUMBER	PART NUMBER
---------------------	-------------	-------------	-------------

## SECTION 4: SHARKBITE PEX PIPE

SharkBite PEX Pipe is a cross-linked polyethylene pipe for use in a wide range of residential and commercial plumbing applications. Manufactured without an oxygen barrier for potable water systems and with an oxygen barrier for radiant floor and hydronic heating applications. A repeating SharkBite imprint pattern provides a visual aid to determine if the pipe has been inserted all the way into the SharkBite push-to-connect fitting. This feature only works if the pipe is cut between the SharkBite imprint pattern.

APPROVALS: The SharkBite pipe with and without oxygen barrier is approved for use in all model codes in the US and Canada, for use in hydronic and potable water systems, and is certified to the following standards: ASTM F876, ASTM F877, CSA B137.5 and AWWA C904.

### 4-A: POTABLE WATER PEX PIPE

PEX PIPE (COILS)	WHITE	RED	BLUE
1/4" (3/8" OD) 50' Coil Pipe	U850W50		
1/4" (3/8" OD) 100' Coil Pipe	U850W100		
3/8" 50' Coil Pipe	U855W50		
3/8" 100' Coil Pipe	U855W100	U855R100	U855B100
1/2" 25' Coil Pipe	U860W25W	U860R25W	U860B25W
1/2" 50' Coil Pipe	U860W50W	U860R50W	U860B50W
1/2" 100' Coil Pipe	U860W100W	U860R100W	U860B100W
1/2" 300' Coil Pipe	U860W300W	U860R300W	U860B300W
1/2" 500' Coil Pipe	U860W500W	U860R500W	U860B500W
1/2" 1000' Coil Pipe	U860W1000W	U860R1000W	U860B1000W
3/4" 25' Coil Pipe	U870W25W	U870R25W	U870B25W
3/4" 50' Coil Pipe	U870W50W	U870R50W	U870B50W
3/4" 100' Coil Pipe	U870W100W	U870R100W	U870B100W
3/4" 300' Coil Pipe	U870W300W	U870R300W	U870B300W
3/4" 500' Coil Pipe	U870W500W	U870R500W	U870B500W
1" 100' Coil Pipe	U880W100W	U880R100W	U880B100W
1" 300' Coil Pipe	U880W300W	U880R300W	U880B300W
1" 500' Coil Pipe	U880W500W	U880R500W	U880B500W
1-1/4" 100' Coil Pipe	U885W100		
1-1/2" 100' Coil Pipe	U890W100		
2" 100' Coil Pipe	U895W100		
PEX PIPE (STRAIGHT LENGTHS)	WHITE	RED	BLUE
1/4" (3/8" OD) 5' Length Pipe	U850W5		
3/8" 5' Length Pipe	U855W5		
3/8" 10' Length Pipe	U855W10		
1/2" 2' Length Pipe	U860W2	U860R2	U860B2
1/2" 5' Length Pipe	U860W5	U860R5	U860B5
1/2" 10' Length Pipe	U860W10	U860R10	U860B10
1/2" 20' Length Pipe	U860W20	U860R20	U860B20
3/4" 2' Length Pipe	U870W2	U870R2	U870B2
3/4" 5' Length Pipe	U870W5	U870R5	U870B5
3/4" 10' Length Pipe	U870W10	U870R10	U870B10
3/4" 20' Length Pipe	U870W20	U870R20	U870B20
1" 5' Length Pipe	U880W5	U880R5	U880B5



PRODUCT DESCRIPTION	PART NUMBER	PART NUMBER	PART NUMBER
1" 10' Length Pipe	U880W10	U880R10	U880B10
1" 20' Length Pipe	U880W20	U880R20	U880B20
1-1/4" 20' Length Pipe	U885W20		
1-1/2" 20' Length Pipe	U890W20		
2" 20' Length Pipe	U895W20		

PRODUCT DESCRIPTION	PART NUMBER
<b>4-B: SPECIAL APPLICATION PEX PIPE</b>	
<b>RECLAIMED WATER PEX PIPE</b>	RECLAIMED
SharkBite reclaimed water PEX is cross-linked polyethylene pipe for gray water, rainwater harvesting and reclaimed water systems only. Manufactured with a purple color background, the pipe meets color code requirements of national and state code bodies to clearly identify reclaimed water lines. SharkBite reclaimed water PEX is manufactured and available in 1/2" to 1".	
1/2" 100' Coil Purple Pipe	U860P100
1/2" 300' Coil Purple Pipe	U860P300
3/4" 100' Coil Purple Pipe	U870P100
3/4" 300' Coil Purple Pipe	U870P300
1" 100' Coil Purple Pipe	U880P100
1" 300' Coil Purple Pipe	U880P300
<b>OXYGEN BARRIER PEX PIPE (COILS)</b>	OXYGEN BARRIER
Use for underfloor radiant and hydronic heating applications. The oxygen diffusion barrier is applied to the exterior and limits oxygen permeation through the pipe wall in hydronic heating applications. This prevents corrosion of ferrous metal parts in the heating system.	
3/8" 100' Coil PEX Pipe Orange Color w/ Black Text	U8550100
3/8" 300' Coil PEX Pipe Orange Color w/ Black Text	U8550300
3/8" 500' Coil PEX Pipe Orange Color w/ Black Text	U8550500
1/2" 100' Coil PEX Pipe Orange Color w/ Black Text	U8600100
1/2" 300' Coil PEX Pipe Orange Color w/ Black Text	U8600300
1/2" 500' Coil PEX Pipe Orange Color w/ Black Text	U8600500
1/2" 1000' Coil PEX Pipe Orange Color w/ Black Text	U86001000
5/8" 300' Coil PEX Pipe Orange Color w/ Black Text	U8650300
3/4" 100' Coil PEX Pipe Orange Color w/ Black Text	U8700100
3/4" 300' Coil PEX Pipe Orange Color w/ Black Text	U8700300
3/4" 500' Coil PEX Pipe Orange Color w/ Black Text	U8700500
3/4" 1000' Coil PEX Pipe Orange Color w/ Black Text	U87001000
1" 100' Coil PEX Pipe Orange Color w/ Black Text	U8800100
1" 300' Coil PEX Pipe Orange Color w/ Black Text	U8800300
1" 500' Coil PEX Pipe Orange Color w/ Black Text	U8800500
<b>OXYGEN BARRIER PEX PIPE (STRAIGHT LENGTHS)</b>	OXYGEN BARRIER
Use for radiant floor and hydronic heating applications. The oxygen diffusion barrier is applied to the exterior and limits oxygen permeation through the pipe wall in hydronic heating applications. This prevents corrosion of ferrous metal parts in the heating system.	
1/2" 20' Length O2 barrier PEX Pipe Orange Color	U860020
3/4" 20' Length O2 barrier PEX Pipe Orange Color	U870020
1" 20' Length O2 barrier PEX Pipe Orange Color	U880020

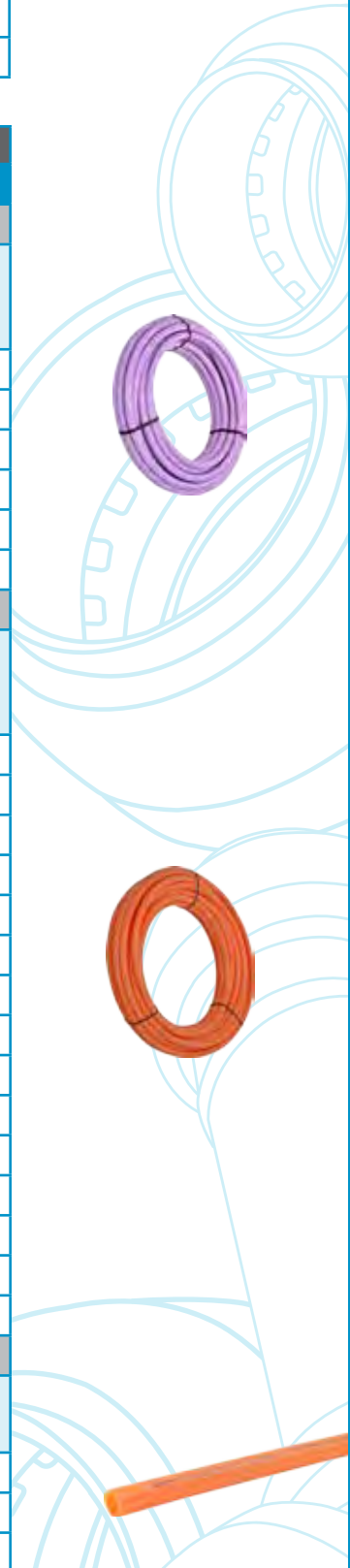

# LIMITED WARRANTY

## SHARKBITE® AND CASH ACME® PRODUCTS

### WHAT DOES THIS WARRANTY COVER?

Subject to conditions outlined in this statement, RWC (in the USA, Reliance Worldwide Corporation and in Canada, Reliance Worldwide Corporation (Canada) Inc.) warrants to owners of real property in the United States and Canada that SharkBite and Cash Acme products, when used and installed in accordance with the requirements set forth, shall be free from defects in material and workmanship for the applicable Warranty Period. This Limited Warranty is in effect for installations made after January 1, 2016 and is applicable to products installed in the country in which they were purchased.

Proof of purchase is required to validate the Warranty Period. If proof of purchase is not available, the Warranty Period commencement shall default to the date of manufacture for each product. If the product suspected of a defect does not have a clear date of manufacture on it, a proof of purchase will be required.

### WHAT ARE THE CONDITIONS OF THIS WARRANTY?

1. All products must be installed in accordance with all then applicable codes, good plumbing practice, in accordance with any local, state, provincial or federal requirements, and installed in a potable water or radiant heating application unless a non-potable water service is specifically allowed for in the pertinent product literature.
2. The installer must use construction techniques compliant with then applicable codes to install the product and use the product within the design parameters specified in any installation guidelines and technical notes for the applicable system. This shall include field pressure testing prior to concealing with concrete or by other means and wrapping any brass fitting when buried. Failure to install RWC products according to manufacturer's installation instruction will void all applicable warranties and may result in severe water damage.
3. Products must at all times be used in a manner consistent with their intended use and be used in installations and environments acceptable to their material and design specifications, including not being installed in a system that may operate at temperatures or at pressures that exceed the approved ratings which can be found on the product, packaging or installation instructions.
4. Additional product specific conditions of this Limited Warranty and the Warranty Period are documented in the section entitled "HOW LONG DOES THE LIMITED WARRANTY COVERAGE LAST AND WHAT OTHER SPECIFIC CONDITIONS EXIST FOR EACH PRODUCT?". A condition for SharkBite Connection Systems is that the product must be installed by a licensed professional plumbing contractor.
5. Without limiting the foregoing, this Limited Warranty does not apply and you do not have a right of reimbursement if the product failure or resulting damage is caused by: (a) evidence of tampering, mishandling, neglect, abuse, accidental damage, freeze damage (it is expressly understood that failure as a result of any freezing fluids within the pipes does not constitute a defect in material or workmanship and shall not be covered by this warranty) or unauthorized modifications or repairs that cause damage to warranted products; (b) exposure to harmful, unauthorized, or unanticipated chemicals or substances or corrosive water conditions; (c) exposure to ultraviolet light; (d) faulty installation including failure to follow proper burial instructions; (e) damage from abnormal operating conditions including exposure pressures and temperatures beyond the specified operating range; (f) failure to properly test and pass common testing methods (including pressure testing) after the installation and before the product or system is put in service; (g) components not manufactured or sold by RWC; or (h) acts of nature such as earthquakes, fire, flood or lightning.
6. Although RWC provides a plumbing system to facilitate a complete installation, other manufacturers pipe and/or fittings may be installed in any given installation provided manufacturing of the pipe and/or fittings demonstrates compliance with the applicable ASTM/CSA standards, and the product has been certified by a recognized third-party testing agency. The RWC product in the given installation will continue to be covered under this Limited Warranty although limits on Warranty Period may apply. RWC will be responsible only for proven defects in material or workmanship in RWC products. Problems in products manufactured by another company should be reported to that manufacturer.

### HOW DO YOU GET SERVICE?

In order to be eligible for service under this Limited Warranty you must return the defective product to RWC for inspection and testing within thirty (30) days after detection of alleged failure or defect occurring within applicable Warranty Period (with shipping charges prepaid) to the original place of purchase. If the alleged

defect involves a connection or joint with a RWC product, the fitting must be returned with a section of the pipe still inserted. You must include the model number of the product (if available), the original date of purchase, proof of purchase and the nature of the alleged product failure or defect. Products returned without shipping charges prepaid will be refused. For questions or inquiries, in the U.S. call 1(877)700-4242 and in Canada 1(888)820-0120.

### WHAT WILL RWC DO?

If, after inspection, we find that a product covered by this Limited Warranty has failed due to a defect in material or workmanship during the specified Warranty Period, we will repair or replace, at our sole option, free of charge, the defective product during normal working hours and through a place of business as determined by RWC.

Notwithstanding anything to the contrary in this Limited Warranty, if RWC determines that any damages to the real property in which a defective product was installed were the direct result of a leak or failure caused by a defect in material or workmanship in any RWC product covered by this Limited Warranty and occurring within the first ten years after date of purchase or during the applicable Warranty Period, whichever is shorter, and if reasonable steps were taken to promptly limit or stop the effects of such leak or failure as soon as it was discovered, then RWC will reimburse the property owner for the reasonable costs of repairing or replacing such damaged real property to include flooring, drywall and painting and other real property damaged by the leak directly caused by the allegedly defective RWC product. Except as specified above or otherwise specifically authorized in writing by RWC, RWC shall not pay for any costs or expenses for transportation, relocation, labor, repairs or any other work associated with removing and/or returning failed or defective products or installing replacement products.

This shall constitute the sole and exclusive remedy for any defective product.

### WHAT DOES THIS LIMITED WARRANTY NOT COVER?

RWC shall not be responsible for any other incidental, indirect, contingent, special or consequential damages, including without limitation, economic loss, lost profits or the cost of repairing or replacing other property which is damaged if these warranted products do not work properly, other costs resulting from labor charges, delays, vandalism, negligence, fouling caused by foreign material, damage from adverse water conditions, adverse chemical environments, or any other circumstances over which RWC has no control. This limitation applies even if RWC could have foreseen or has been advised of the possibility of these damages. This Limited Warranty shall be invalidated by any abuse, misuse, misapplication or improper installation of the product. Any remaining warranty coverage may not be assigned or transferred after the period ending ten years following the installation. RWC does not guarantee or in any way warrant the integrity or workmanship of the contractor/installer.

### MISCELLANEOUS

Some States/Provinces do not allow limitations on how long an implied warranty lasts, and some States/Provinces do not allow the exclusion or limitation of incidental or consequential damages. Therefore, the above limitations may not apply to you. This Limited Warranty gives you specific legal rights, and you may have other rights that vary from State/Province to State/Province. You should consult applicable State/Provincial laws to determine your rights.

SO FAR AS IS CONSISTENT WITH APPLICABLE STATE/ PROVINCIAL/ FEDERAL LAW, THE EXPRESS WARRANTY SET FORTH HEREIN IS THE ONLY WARRANTY GIVEN BY RWC WITH RESPECT TO THE SHARKBITE® AND CASH ACME® PRODUCTS AND RWC MAKES NO OTHER WARRANTIES, EXPRESSED OR IMPLIED, AND HEREBY SPECIFICALLY DISCLAIMS ALL OTHER WARRANTIES, EXPRESSED OR IMPLIED, INCLUDING BUT NOT LIMITED TO THE IMPLIED WARRANTIES OF MERCHANTABILITY AND FITNESS FOR A PARTICULAR PURPOSE.

This Limited Warranty and any claims arising from breach of contract, breach of warranty, tort, or any other claim arising from sale or use of RWC's products shall be governed and construed under the laws of the State of Georgia. No action on the part of RWC under this Limited Warranty shall be construed as an admission of liability of that the product is not fit for its intended use.

## HOW LONG DOES THE LIMITED WARRANTY COVERAGE LAST AND WHAT OTHER SPECIFIC CONDITIONS EXIST FOR EACH PRODUCT?

CLASSIFICATION	PRODUCT CATEGORY	LIMITED WARRANTY PERIOD	CONDITIONS
SharkBite Connection Systems	SharkBite Brass and Poly PEX Barb Fittings in conjunction with SharkBite PEX Pipe and SharkBite Rings/Clamps	Twenty-Five (25) Years	System must be installed by a licensed professional plumbing contractor and include: <ul style="list-style-type: none"> <li>• SharkBite PEX Pipe Only - ASTM F876/CSA B137.5</li> <li>• SharkBite Copper Crimp Rings – ASTM F1807 or F2159</li> <li>• Stainless Steel Clamp Rings – ASTM F2098</li> </ul>
SharkBite and Cash Acme Products	SharkBite Universal Push-to-Connect Fittings and SharkBite 2XL Large Diameter Push-to-Connect Fittings in Application with Copper, PEX, CPVC and/or PE-RT	Twenty-Five (25) Years	Must be used with: <ul style="list-style-type: none"> <li>• Copper–ASTM B 88 hard drawn copper tube K, L, and M</li> <li>• PEX–ASTM F876/CSA B137.5</li> <li>• CPVC–ASTM D2846 or CSA B137.6</li> <li>• PE-RT–ASTM F2769</li> </ul>
	SharkBite Universal Push-to-Connect Fittings and SharkBite 2XL Large Diameter Push-to-Connect Fittings in Application with HDPE	Five (5) Years	Must be used with: <ul style="list-style-type: none"> <li>• HDPE SDR-9 ASTM D2737</li> </ul>
	SharkBite PEX Pipe	Twenty-Five (25) Years	Must be used with: <ul style="list-style-type: none"> <li>• ASSE 1061, ASTM F1807, ASTM F2098, and/or ASTM F2159 fittings</li> </ul>
	SharkBite Brass PEX Barb Fittings/ Copper Manifold	Five (5) Years	Must be used with Non-SharkBite PEX Pipe and Clamps/Rings that conform to: <ul style="list-style-type: none"> <li>• PEX – ASTM F876/CSA B137.5</li> <li>• Copper Crimp Rings – ASTM F1807</li> <li>• Stainless Steel Clamp Rings – ASTM F2098</li> </ul>
	SharkBite Poly PEX Barb Fittings	Five (5) Years	Must be used with Non-SharkBite PEX Pipe and Clamps/Rings that conform to: <ul style="list-style-type: none"> <li>• PEX – ASTM F876/CSA B137.5</li> <li>• Copper Crimp Rings – ASTM F2159</li> <li>• Stainless Steel Clamp Rings – ASTM F2098</li> </ul>
	SharkBite Tools	One (1) Year	From date of purchase; used in accordance with instructions
	SharkBite and Cash Acme Thermostatic Mixing Valves	Five (5) Years	Must be installed per installation instructions
	Other SharkBite and Cash Acme Valves	Two (2) Years	Must be installed per installation instructions
	SharkBite Accessories (Ball Valves, Supply Hoses, Supply Stops, Supply Valve Box Systems, Kits, Manifolds, etc.)	Two (2) Years	Must be installed per installation instructions

# SHARKBITE®

## PUSH-TO-CONNECT FITTINGS

- The SharkBite push-to-connect range is made from Lead Free DZR brass and all products were converted as of October 2012.
- The standard material versions of SharkBite push-to-connect fittings are no longer in production, but we do continue to offer a small range of 5/8" fittings in standard material, specifically intended for radiant heating applications. As a running change, these fittings will be converted to Lead Free in due course.
- Our SharkBite 2XL large Diameter fittings have been Lead Free since their introduction in February 2011.

# SHARKBITE

## PEX/BARB FITTINGS

- Our PEX/barb range is made from Lead Free DZR brass and all products were converted as of October 2012.
- We have also implemented an extended range of engineered polymer barb fittings.

## LEAD FREE\*



As of January 2014 a new Federal law came into effect that introduced a similar requirement across the whole country.

More information is available on our websites at:

[www.cashacme.com](http://www.cashacme.com)

[www.sharkbite.com](http://www.sharkbite.com)

In this document, products are marked “Lead Free” or “Non-Potable” as applicable.

- “Lead Free” indicates that a product is suitable for use in an application that is anticipated or intended to deliver water for human consumption.
- “Non-Potable” designates that a product is only suitable for applications that are not anticipated or intended to deliver water for human consumption.

If a product is not marked “Lead Free” or “Non-Potable” it is either:

- Not designed to come into contact with water (e.g. tools, crimp rings, pipe hangers), or
- It is a replacement part or component for a valve or piece of Original Equipment, where it is necessary for the function of that valve or equipment to use the identical specification component with which it was originally designed and certified.

*\* A device is defined as Lead Free if its wetted surface has a weighted average lead content not exceeding 0.25%.*

Part Number	Page	Part Number	Page	Part Number	Page	Part Number	Page	Part Number	Page
22182-0000LF	13	23102	18	RM22720	18	SS3088FLEX18LF	8	U314LF	5
22185-0000LF	13	23102CP25	18	RM22724	18	SS3088FLEX24LF	8	U332LF	5
22186-0000LF	13	23102CP100	18	S80135	3	U004LF	3	U334LF	5
22187-0000LF	13	23103	18	S8013528	3	U006LF	3	U335LF	5
22222-0000LF	13	23103CP25	18	S80141	3	U008LF	3	U3358LF	10
22223-0000LF	13	23103CP100	18	S8014128	3	U009LF	3	U3362LF	6
22304-0000LF	13	23104	18	S8014135	3	U012	7	U3370LF	6
22305-0000LF	13	23104CP25	18	S80154	3	U016LF	3	U340LF	5
22306-0000LF	13	23220	19	S8015441	3	U020LF	3	U3482LF	6
22441LF	10	23221	19	S80235	4	U050LF	3	U3486LF	6
22461LF	18	23251	19	S80241	4	U057	7	U351LFA	10
22462LF	18	23336-0000LF	9	S80254	4	U058LF	3	U3523LF	9
22463LF	18	23337-0000LF	9	S80335	6	U060LF	3	U3524LF	9
22486LF	11	23358-0045	12	S803353516	6	U066LF	4	U3525LF	10
22604LF	10	23382LF	17	S803353522	6	U068LF	4	U3531LF	10
22630LF	10	23383	19	S803353528	6	U070LF	4	U3537LF	10
22631LF	10	23489	9	S80341	6	U072LF	4	U358LF	5
22632LF	10	23490	9	S803414122	6	U086LF	6	U359LF	5
22633LF	10	23807-0045	12	S803414128	6	U088LF	4	U360LF	5
22675-0045	12	23808-0045	12	S803414135	6	U092LF	4	U362LF	5
22783	18	23893-0045	12	S80354	6	U094LF	4	U363LF	5
22784	18	23894-0045	12	S803545428	6	U110LF	4	U364LF	5
22785	18	23896-0060	12	S803545435	6	U116LF	4	U366	7
22786	18	23945-0060	12	S803545441	6	U118LF	4	U370LF	5
22787	18	23955-0045	12	S80435	6	U120LF	4	U3712	11
22788	18	23956-0045	12	S80441	6	U126	7	U374LF	5
22789	18	24383-0045	12	S80454	6	U134LF	4	U4008LF	7
22790	18	24384-0045	12	S80535	4	U138LF	4	U4016LF	7
22791	17	24436	10	S80541	4	U139LF	4	U412LF	5
22995LF	10	24437	10	S80554	4	U140LF	4	U416LF	5
22996LF	10	24438	10	S80635	3	U142LF	4	U4358LF	10
22997LF	10	24439	10	S80641	3	U2008-0000LF	13	U444LF	5
22998LF	10	24440	10	S80654	3	U2016-0000LF	13	U4482LF	6
23036-0000LF	9	24441	10	S80735	4	U2020-0000LF	13	U454LF	5
23037-0000LF	9	24442	10	S80741	4	U2276LF	5	U462LF	6
23048-0000LF	9	24443	10	S80754	4	U244LF	4	U464LF	6
23049-0000LF	9	24444	10	S80835	5	U246LF	4	U512LF	6
23050	19	24445	10	S808353516	5	U248LF	4	U514LF	6
23051	19	24449-0045	12	S808353522	5	U249LF	5	U516	7
23053	19	24504	12	S808353528	5	U252	7	U518LF	6
23054	19	24505	12	S80841	5	U256LF	4	U520LF	6
23055	19	24529	12	S808414122	5	U260LF	4	U701	19
23056LF	17	24530	12	S808414128	5	U272LF	5	U702	11
23057LF	17	24731LF	9	S808414135	5	U273	7	U706	11
23058LF	17	24732LF	9	S80854	5	U274LF	5	U708	11
23059LF	17	24733LF	9	S808545428	6	U276LF	5	U710	11
23060LF	17	24734LF	9	S808545435	6	U278LF	5	U711	11
23061LF	17	24735LF	13	S808545441	6	U280LF	5	U712	11
23062LF	17	24736LF	13	S8113532F	4	U281LF	5	U713	11
23063LF	17	24737LF	13	S8113532M	4	U286LF	5	U714	11
23064LF	17	24946	9	S8114140F	4	U3001A	11	U715	11
23065	19	24947	9	S8114140M	4	U3008FLEX18LF	9	U719LF	6
23067LF	15	24983	9	S8115450F	4	U3008LF	3	U721LF	6
23068LF	15	24984	9	S8115450M	4	U308LF	3	U722LF	6
23069	17	24985	9	S8BV35	13	U3016FLEX18LF	9	U724LF	6
23070	17	24986	9	S8BV41	13	U3016LF	3	U766LF	4
23071A10	19	24987	9	S8BV54	13	U3020LF	3	U772LF	4
23072A10	19	25024	11	S8DC35	11	U3068FLEX12LF	8	U782LF	9
23073A10	19	25087	11	S8DC354154	11	U3068FLEX15LF	8	U850W5	22
23074A10	19	25088	11	S8DC41	11	U3068FLEX18VLF	8	U850W50	22
23075A10	19	25096	11	S8DC54	11	U3068FLEX18LF	8	U850W100	22
23076A10	19	25097	11	S8G03	11	U3068FLEX24LF	8	U8550100	23
23080	19	25098	11	S8TL35	12	U3086FLEX24LF	9	U8550300	23
23081	19	25099	11	S8TL41	12	U3088FLEX12LF	8	U8550500	23
23100	19	25401	18	S8TL54	12	U3088FLEX15LF	8	U8558100	22
23101	18	25404	11	SS3068FLEX18BV	9	U3088FLEX18VLF	8	U855R100	22
23101CP25	18	25406	12	SS3086FLEX24LF	8	U3088FLEX18LF	8	U855W5	22
23101CP100	18	RM22716	18	SS3088FLEX18BV	9	U3088FLEX24LF	8	U855W10	22

Part Number .....	Page	Part Number .....	Page	Part Number .....	Page	Part Number .....	Page
U855W50 .....	22	U870W10 .....	22	UC286LF .....	14	UF12128H .....	8
U855W100 .....	22	U870W20 .....	22	UC334LF .....	14	UF12128V .....	8
U860B2 .....	22	U870W25W .....	22	UC340LF .....	14	UF128L .....	8
U860B5 .....	22	U870W50W .....	22	UC342LF .....	14	UF128R .....	8
U860B10 .....	22	U870W100W .....	22	UC360LF .....	14	UF128S .....	8
U860B20 .....	22	U870W300W .....	22	UC362LF .....	14	UF128U .....	8
U860B25W .....	22	U870W500W .....	22	UC363LF .....	15	UF16128H .....	8
U860B50W .....	22	U880B5 .....	22	UC364LF .....	15	UF16128V .....	8
U860B100W .....	22	U880B10 .....	23	UC370LF .....	14	UF16168H .....	8
U860B300W .....	22	U880B20 .....	23	UC374LF .....	14	UF16168V .....	8
U860B500W .....	22	U880B100W .....	22	UC4006LF .....	15	UF168L .....	8
U860B1000W .....	22	U880B300W .....	22	UC4008LF .....	15	UF168R .....	8
U860Q20 .....	23	U880B500W .....	22	UC4016LF .....	15	UF168U .....	8
U860Q100 .....	23	U880Q20 .....	23	UC408LF .....	15	UFH034 .....	19
U860Q300 .....	23	U880Q100 .....	23	UC412LF .....	15	UIP120 .....	7
U860Q500 .....	23	U880Q300 .....	23	UC413LF .....	15	UIP134 .....	7
U860Q1000 .....	23	U880Q500 .....	23	UC414LF .....	15	UIP140 .....	7
U860P100 .....	23	U880P100 .....	23	UC415LF .....	15	UIP3008 .....	7
U860P300 .....	23	U880P300 .....	23	UC416LF .....	15	UIP3016 .....	7
860R2 .....	22	U880R5 .....	22	UC417LF .....	15	UIP3020 .....	7
860R5 .....	22	U880R10 .....	23	UC418LF .....	15	UIP363 .....	7
860R10 .....	22	U880R20 .....	23	UC434LF .....	15	UIP364 .....	7
860R20 .....	22	U880R100W .....	22	UC444LF .....	15	UIP371 .....	7
U860R25W .....	22	U880R300W .....	22	UC452LF .....	15	UIP372 .....	7
U860R50W .....	22	U880R500W .....	22	UC454LF .....	15	UIP375 .....	7
U860R100W .....	22	U880W5 .....	22	UC512LF .....	15	UIP376 .....	7
U860R300W .....	22	U880W10 .....	23	UC514LF .....	15	UIP4008 .....	7
U860R500W .....	22	U880W20 .....	23	UC518LF .....	15	UIP4016 .....	7
U860R1000W .....	22	U880W100W .....	22	UC520LF .....	15	UIP4020 .....	7
U860W2 .....	22	U880W300W .....	22	UC526LF .....	15	UIP710 .....	7
U860W5 .....	22	U880W500W .....	22	UC527LF .....	15	UIP712 .....	7
U860W10 .....	22	U885W20 .....	23	UC528LF .....	15	UIP714 .....	7
U860W20 .....	22	U885W100 .....	22	UC529LF .....	15	UP008 .....	16
U860W25W .....	22	U890W20 .....	23	UC530LF .....	15	UP016 .....	16
U860W50W .....	22	U890W100 .....	22	UC531LF .....	15	UP020 .....	16
U860W100W .....	22	U895W20 .....	23	UC532LF .....	15	UP058 .....	16
U860W300W .....	22	U895W100 .....	22	UC534LF .....	15	UP060 .....	16
U860W500W .....	22	UC006LF .....	13	UC594LF .....	15	UP120 .....	16
U860W1000W .....	22	UC008LF .....	13	UC600LF .....	14	UP134 .....	16
U8650300 .....	23	UC009LF .....	13	UC605LF .....	14	UP138 .....	16
U870B2 .....	22	UC012LF .....	13	UC606LF .....	14	UP140 .....	16
U870B5 .....	22	UC016LF .....	13	UC607LF .....	14	UP248 .....	16
U870B10 .....	22	UC020LF .....	13	UC608LF .....	14	UP256 .....	16
U870B20 .....	22	UC057LF .....	13	UC609LF .....	14	UP260 .....	16
U870B25W .....	22	UC058LF .....	13	UC626LF .....	14	UP274 .....	16
U870B50W .....	22	UC060LF .....	13	UC628LF .....	14	UP280 .....	16
U870B100W .....	22	UC068LF .....	13	UC952 .....	18	UP360 .....	16
U870B300W .....	22	UC072LF .....	13	UC953 .....	18	UP362 .....	16
U870B500W .....	22	UC088LF .....	14	UC954 .....	18	UP370 .....	16
U870Q20 .....	23	UC094LF .....	14	UC955 .....	18	UP374 .....	16
U870Q100 .....	23	UC116LF .....	14	UC956 .....	18	UP408 .....	16
U870Q300 .....	23	UC118LF .....	14	UC961 .....	19	UP412 .....	16
U870Q500 .....	23	UC120LF .....	14	UCF12128A .....	17	UP414 .....	16
U870Q1000 .....	23	UC134LF .....	14	UCF12128H .....	17	UP415 .....	16
U870P100 .....	23	UC138LF .....	14	UCF12128V .....	17	UP416 .....	16
U870P300 .....	23	UC139LF .....	14	UCF128L .....	17	UP444 .....	16
U870R2 .....	22	UC140LF .....	14	UCF128R .....	17	UP454 .....	16
U870R5 .....	22	UC142LF .....	14	UCF128S .....	17	UP514 .....	16
U870R10 .....	22	UC246LF .....	14	UCF128U .....	17	UP518 .....	16
U870R20 .....	22	UC248LF .....	14	UCF16128H .....	17	UP520 .....	16
U870R25W .....	22	UC256LF .....	14	UCF16128V .....	17	UP526 .....	16
U870R50W .....	22	UC260LF .....	14	UCF16168H .....	17	UP527 .....	16
U870R100W .....	22	UC272LF .....	14	UCF16168V .....	17	UP532 .....	16
U870R300W .....	22	UC274LF .....	14	UCF168L .....	17		
U870R500W .....	22	UC273LF .....	14	UCF168R .....	17		
U870W2 .....	22	UC278LF .....	14	UCF168U .....	17		
U870W5 .....	22	UC280LF .....	14	UCF12128A .....	8		





# CERTIFICATIONS

The SharkBite push-to-connect fittings have been design certified and listed to ASSE 1061/NSF 61. The SharkBite push-to-connect fittings are listed by IAPMO and are certified for potable and hydronic heating water distribution (Note: Glycol mixture for hydronics is acceptable up to and including 100%). The SharkBite push-to-connect fittings have been certified for underground applications and as a manufactured joint without access panels and they meet UPC, IPC and cUPC requirements. Any SharkBite fitting listed as Lead Free is compliant with NSF/ANSI 372. Please consult with local plumbing codes concerning specific applications.

The SharkBite pipe without oxygen barrier is approved for all model codes in the US and Canada for use in potable water systems and is certified to the following standards: ASTM F 876, ASTM F 877, CSA B137.5 and AWWA C904.

The SharkBite pipe with oxygen barrier is approved for use in all model codes in the US and Canada for use in hydronic and potable water systems and is certified to the following standards: ASTM F 876, ASTM F 877, CSA B137.5 and AWWA C904.

Note: The SharkBite push-to-connect fittings are not approved for use with chrome-plated pipe. SharkBite Polybutylene couplings are designed to work with ASTM D3309 spec polybutylene, do not install onto damaged or decayed PB pipe.



## Reliance Worldwide Corporation

2727 Paces Ferry Road SE  
Building 2, Suite 1800  
Atlanta, GA 30339

Phone: 1-877-700-4242 • Fax: 1-877-700-4280  
[www.rwc.com](http://www.rwc.com)



[www.sharkbite.com](http://www.sharkbite.com) | [www.cashacme.com](http://www.cashacme.com)

MANUFACTURED AND DISTRIBUTED BY RELIANCE WORLDWIDE CORPORATION