



# Cutler-Hammer

## Motor Control Center Type W

Renewal Parts

Supersedes RP.03A.06.S.E  
pages 1-24, dated September 2000

### Description

#### Motor Control Center Type W

	<i>Page</i>
Distributor Ordering Instructions . . . . .	2
Procedure for Identifying MCC Renewal Units and Parts . . . . .	2
Identifying Motor Control Center Types . . . . .	3
Identification by Original Handle Mechanism . . . . .	3
Procedure for Identifying Motor Control Center Types . . . . .	4
Type W Product Description . . . . .	5
Replacement Starter Units . . . . .	6 – 9
Unit Options . . . . .	10 – 12
Structure Parts . . . . .	13 – 16
Unit Parts . . . . .	17 – 19
Series C® Retrofit Kits . . . . .	20
Replacement Feeder Units (All Vintages) . . . . .	23

MCC Type	Dates	Cutler-Hammer Renewal Parts Publication
F2100 Advantage™ Series 2100	1995 – 1992 – 1987 – 95	RP04304001E RP04304002E RP04304003E
5 Star Freedom Unitrol F10 Unitrol	1975 – 87 1988 – 94 1972 – 89	RP04304003E RP04304004E RP04304005E
Type W 9800 Unitrol 11-300	1965 – 75 1956 – 74 1935 – 65	RP04304006E RP04304007E RP04304008E

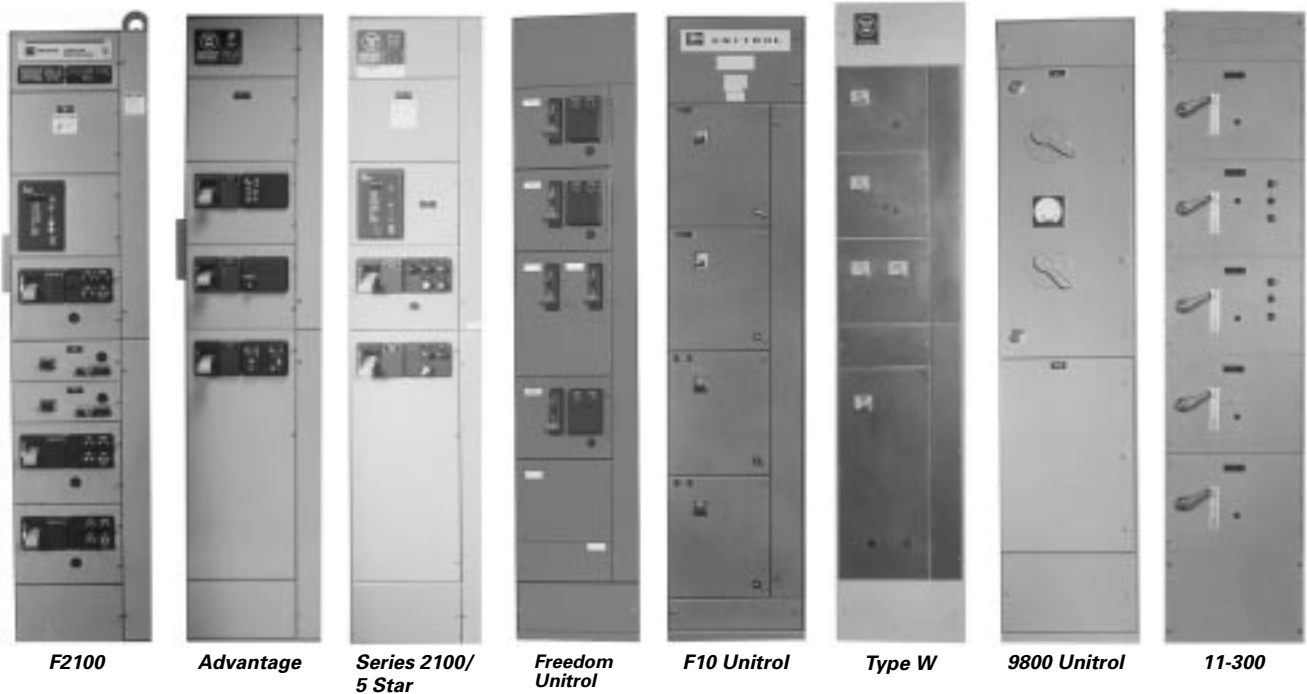

## Identifying Motor Control Center Types

In most cases, it is possible to identify MCC design by handle type. Starter type, bucket width and door width can assist in identification.

**Table 1. Identifying Motor Control Center Types**

MCC Type	Type of Handle Mechanism	Original MCC Starter Type	Bucket Width Inches (mm)	Door Width Inches (mm)	Original Manufacturer ①	Starter Type (Installed in New Unit)
F2100 ②	Lever	Freedom Series	13-3/4 (349.3)	15-5/8 (397.0)	Cutler-Hammer 1994 to Present	Freedom
Advantage ②	Lever	Advantage	13-3/4 (349.3)	15-5/8 (397.0)	Westinghouse until 1994 Cutler-Hammer 1994 to Present	Advantage
Series 2100 ②	Lever	A200	13-3/4 (349.3)	15-5/8 (397.0)	Westinghouse until 1994 Cutler-Hammer 1994 to Present	A200
5 Star ②	Lever	A200	13-3/4 (349.3)	15-5/8 (397.0)	Westinghouse 1975 – 1987	A200
Freedom Unitrol	Slider	Freedom Series	13-7/8 (352.5)	15-1/2 (393.7)	Cutler-Hammer 1988 – 1994	Freedom
F10 Unitrol	Slider and Lever	Citation	14 (355.6)	14-3/4 (374.7) w/ Wireway 19-1/2 (495.3) w/o Wireway	Cutler-Hammer 1972 – 1989	Freedom
Type W	Slider	A200 or 11-200	11-3/4 (298.5)	13-3/8 (339.9)	Westinghouse 1965 – 1975	A200
9800 Unitrol	Rotary ③	3 Star/Citation	16-1/8 (409.7)	19-3/8 (492.3)	Cutler-Hammer 1956 – 1974	Freedom
11-300	Rotary	11-200 Lifeline Type N/A200	15-3/4 (400.1)	20 (508.0)	Westinghouse 1950 – 1965	A200

① MCC types were sometimes produced outside the time spans shown. This was due to the overlap of production when a new design was adopted.

② The unit “wrappers” are mechanically identical for these designs.

③ 9800 originally was supplied with Rotary. New replacement units are manufactured with slider handle mechanism.

## Identification by Original Handle Mechanism



**F2100, Advantage,  
Series 2100/5 Star**



**Freedom Unitrol**



**F10 Unitrol Slider  
9800 Unitrol**



**F10 Unitrol Lever  
and 9800 Unitrol**



**Type W**



**9800 Unitrol**

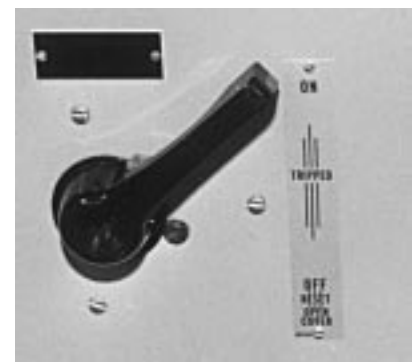

**11-300**

## Procedure for Identifying Motor Control Center Types

In the event that the nameplate is missing, it is possible to identify the MCC design by the type of handle mechanism, starter type, bucket width and door width.

**Table 2. Identifying Motor Control Center Types**

MCC Type	Type of Handle Mechanism	Starter Type	Bucket Width Inches (mm)	Door Width Inches (mm)	Cutler-Hammer Renewal Parts Publication
F2100 Advantage Series 2100	Lever Lever Lever	Freedom Series Advantage A200	13-3/4 (349.3) 13-3/4 (349.3) 13-3/4 (349.3)	15-5/8 (397.0) 15-5/8 (397.0) 15-5/8 (397.0)	RP04304001E RP04304002E RP04304003E
5 Star Freedom Unitrol F10 Unitrol	Lever Slider Lever/Slider	A200 Freedom Series Citation	13-3/4 (349.3) 13-7/8 (352.5) 14 (355.6)	15-5/8 (397.0) 15-1/2 (393.7) 14-3/4 (374.7) w/ Wireway or 19-1/2 (495.3) w/o Wireway	RP04304003E RP04304004E RP04304005E
Type W 9800 Unitrol 11-300	Slider Rotary Rotary	A200 or 11-200 3 Star and/or Citation 11-200 Lifeline N and/or A200	11-3/4 (298.5) 16-1/8 (409.7) 15-3/4 (400.1)	13-3/8 (339.9) 19-3/8 (492.3) 20 (508.0)	RP04304006E RP04304007E RP04304008E



**F2100**

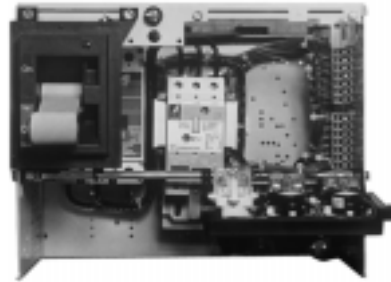

**Advantage**



**Series 2100/5 Star**

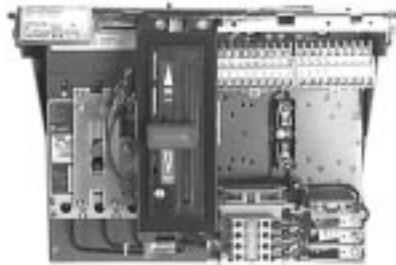

**Freedom Unitrol**

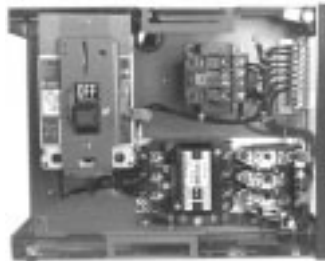

**F10 Unitrol**



**Type W**



**9800 Unitrol**



**11-300**

## Type W Product Description

Manufactured from 1965 to 1975, this Westinghouse MCC used standard structures each 19 inches (482.6 mm) wide, 90 inches (2286.0 mm) high, and either 15 inches (381.0 mm) or 20 inches (508.0 mm) deep for front mounting or 20 inches (508.0 mm) deep for back-to-back mounting. Vertical sections were bolted together forming a single line-up with continuous horizontal bus. Unit height is measured in 6-inch (152.4 mm) increments up to a maximum of 72 inches (1828.8 mm) of usable vertical space. Starter units were 13-1/2 inches (342.9 mm) wide.

A two-tone light/dark enamel paint system was used with an ANSI 70 light gray applied to the structural framework and cover plates. A dark gray was used for unit and wireway doors.

The Type W starter units are easily recognized by their sliding handle mechanism, the MC Motor Control type. Bus and bus support systems were typically braced to withstand fault currents of 22,000A.



*Type W Structure*



*Type W Starter Unit*

**Table 3. Type W Product Rating**

Maximum Ratings
3-Phase, 600V, 400 hp, 2500A Bus

## Type W Replacement Starter Units

### How to Order

When ordering a replacement unit, you receive:

- Series C® HMCP.
- A200 Starter.
- Unit options as specified.
- New steel wrapper, door and handle mechanism.
- New stabs.
- UL® label.

Use the following steps for creating a catalog number for your specific application:

### Step 1

Select the correct replacement unit from **Pages 6 – 10**. When selecting, you need to know the following:

- MCC type.
- Class of Unit (FVNR, FVR, Reduced Voltage — Autotransformer or Part Winding or Solid State, FV – 2 Speed, 1 Winding or 2 Speed, 2 Winding, etc.).
- Starter size or horsepower rating.
- Protection device (breaker or fusible).
- Service voltage.
- Control voltage.
- Space required.

### Step 2

Verify required space is available.

### Step 3

Create a catalog number by selecting Catalog Codes from the columns per the example given.

### Step 4

Add modifications as required from the Unit Options on **Pages 10 – 12**. Space available determines allowable options.

Table 4. Catalog Numbering System Example

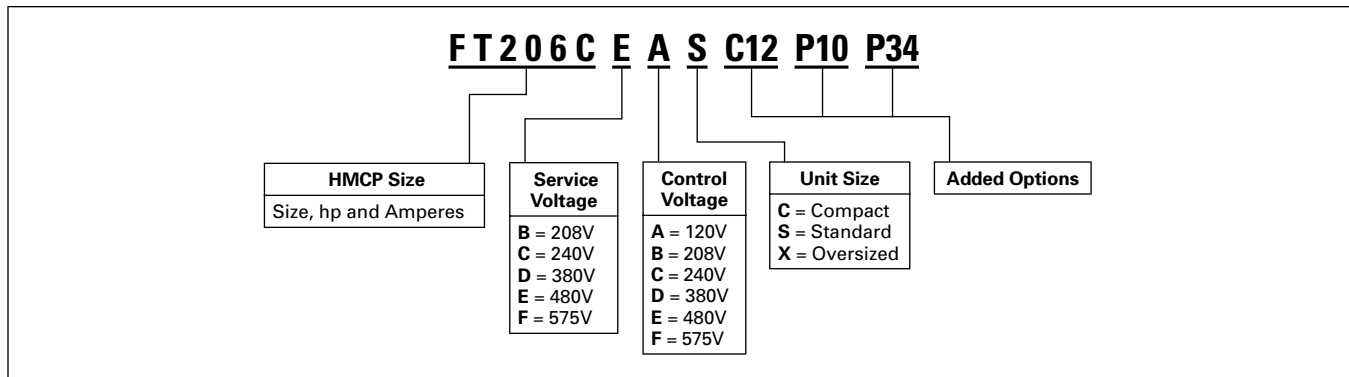

Table 5. Full Voltage Non-Reversing Combination Starter — HMCP

NEMA® Size	Maximum Horsepower					HMCP Size	Catalog Code	Service Voltage	Catalog Code	Control Voltage	Catalog Code	Space Options Inches (mm)	Catalog Code
	208V	240V	380V	480V	600V								
1	0.5	0.33	1	1	1.5	3	<b>FT206A</b> <b>FT206B</b> <b>FT206C</b> <b>FT206D</b>	208	<b>B</b> <b>C</b> <b>D</b> <b>E</b> <b>F</b>	120	<b>A</b> <b>B</b> <b>C</b> <b>D</b> <b>E</b> <b>F</b>	12 (304.8) High 18 (457.2) High	<b>S</b> <b>X</b>
	1	1	2	3	3	7		240		208			
	3	3	5	7.5	7.5	15		380		240			
	7.5	7.5	10	10	10	30		480		380			
								575		480			
2	10	15	25	25	25	50	<b>FT206E</b>	208	<b>B</b> <b>C</b> <b>D</b> <b>E</b> <b>F</b>	120	<b>A</b> <b>B</b> <b>C</b> <b>D</b> <b>E</b> <b>F</b>	12 (304.8) High 18 (457.2) High	<b>S</b> <b>X</b>
								240		208			
								380		240			
								480		380			
								575		480			
3	25	30	50	50	100	<b>FT206H</b>	208	<b>B</b> <b>C</b> <b>D</b> <b>E</b> <b>F</b>	120	<b>A</b> <b>B</b> <b>C</b> <b>D</b> <b>E</b> <b>F</b>	18 (457.2) High	<b>S</b>	
							240		208				
							380		240				
							480		380				
							575		480				
4	40	50	75	100	150	<b>FT206L</b>	208	<b>B</b> <b>C</b> <b>D</b> <b>E</b> <b>F</b>	120	<b>A</b> <b>B</b> <b>C</b> <b>D</b> <b>E</b> <b>F</b>	24 (609.6) High	<b>S</b>	
							240		208				
							380		240				
							480		380				
							575		480				
5	60 75	60 100	125 150	150 200	250 400	<b>FT206P</b> <b>FT206R</b>	208	<b>B</b> <b>C</b> <b>D</b> <b>E</b> <b>F</b>	120	<b>A</b> <b>B</b> <b>C</b> <b>D</b> <b>E</b> <b>F</b>	36 (914.4) High	<b>S</b>	
							240		208				
							380		240				
							480		380				
							575		480				

**Type W Replacement Starter Units**

**Table 6. Full Voltage Reversing Combination Starter — HMCP**

NEMA Size	Maximum Horsepower					HMCP Size	Catalog Code	Service Voltage	Catalog Code	Control Voltage	Catalog Code	Space Options Inches (mm)	Catalog Code
	208V	240V	380V	480V	600V								
1	0.5	0.33	1	1	1.5	3	FT216A	208	B	120	A	18 (457.2) High 24 (609.6) High	S X
	1	1	2	3	3	7	FT216B	240	C	208	B		
	3	3	5	7.5	7.5	15	FT216C	380	D	240	C		
	7.5	7.5	10	10	10	30	FT216D	480	E	380	D		
								575	F	480	E		
							575	F	480	F			
2	10	15	25	25	25	50	FT216E	208	B	120	A	18 (457.2) High 24 (609.6) High	S X
								240	C	208	B		
								380	D	240	C		
								480	E	380	D		
								575	F	480	E		
								575	F	480	F		
3	25	30	50	50	50	100	FT216H	208	B	120	A	24 (609.6) High	S
								240	C	208	B		
								380	D	240	C		
								480	E	380	D		
								575	F	480	E		
								575	F	480	F		
4	40	50	75	100	100	150	FT216L	208	B	120	A	24 (609.6) High	S
								240	C	208	B		
								380	D	240	C		
								480	E	380	D		
								575	F	480	E		
								575	F	480	F		
5	50	60	100	125	150	250	FT216P	208	B	120	A	60 (1524.0) High	S
	75	100	150	200	200	400	FT216R	240	C	208	B		
								380	D	240	C		
								480	E	380	D		
								575	F	480	E		
								575	F	480	F		

**Table 7. Full Voltage 2 Speed 1 Winding — Constant/Variable Torque — HMCP ①**

NEMA Size	Maximum Horsepower					HMCP Size	Catalog Code	Service Voltage	Catalog Code	Control Voltage	Catalog Code	Space Options Inches (mm)	Catalog Code
	208V	240V	380V	480V	600V								
1	0.5	0.33	1	1	1.5	3	FT946A	208	B	120	A	18 (457.2) High 24 (609.6) High	S X
	1	1	2	3	3	7	FT946B	240	C	208	B		
	3	3	5	7.5	7.5	15	FT946C	380	D	240	C		
	7.5	7.5	10	10	10	30	FT946D	480	E	380	D		
								575	F	480	E		
							575	F	480	F			
2	10	15	25	25	25	50	FT946E	208	B	120	A	18 (457.2) High 24 (609.6) High	S X
								240	C	208	B		
								380	D	240	C		
								480	E	380	D		
								575	F	480	E		
								575	F	480	F		
3	25	30	50	50	50	100	FT946H	208	B	120	A	36 (914.4) High	S
								240	C	208	B		
								380	D	240	C		
								480	E	380	D		
								575	F	480	E		
								575	F	480	F		
4	40	50	75	100	100	150	FT946L	208	B	120	A	36 (914.4) High	S
								240	C	208	B		
								380	D	240	C		
								480	E	380	D		
								575	F	480	E		
								575	F	480	F		

① For constant horsepower instead of constant/variable torque, see Option SV6 on Page 12.

## Type W Replacement Starter Units

**Table 8. Full Voltage 2 Speed 2 Winding — Constant/Variable Torque — HMCP** ①

NEMA Size	Maximum Horsepower					HMCP Size	Catalog Code	Service Voltage	Catalog Code	Control Voltage	Catalog Code	Space Options Inches (mm)	Catalog Code																		
	208V	240V	380V	480V	600V																										
1	0.5	0.33	1	1	1.5	3	FT956A FT956B FT956C FT956D	208 240 380 480 575	B C D E F	120 208 240 380 480 575	A B C D E F	18 (457.2) High 24 (609.6) High	S X																		
	1	1	2	3	3																										
	3	3	5	7.5	7.5																										
	7.5	7.5	10	10	10																										
2	10	15	25	25	25	50	FT956E	208 240 380 480 575	B C D E F	120 208 240 380 480 575	A B C D E F	18 (457.2) High 24 (609.6) High	S X																		
	3	25	30	50	50									50	100	FT956H	208 240 380 480 575	B C D E F	120 208 240 380 480 575	A B C D E F	36 (914.4) High	S									
		4	40	50	75									100									100	150	FT956L	208 240 380 480 575	B C D E F	120 208 240 380 480 575	A B C D E F	36 (914.4) High	S

① For constant horsepower instead of constant/variable torque, see Option SV6 on Page 12.

### IT06 — Intelligent Technologies *IT*. Solid-State Reduced Voltage Starter — HMCP

The *IT*. solid-state reduced voltage starter uses SCRs when starting and a low impedance run circuit during operation. Solid-state starters have (5) 24V dc inputs and 2 relay outputs. Soft start units include a disconnect, starter, 24V dc power supply and 100VA CPT.

#### Motor Service Factor (SF) Effect on *IT*. Starter Selection

- A 1.0 service factor motor may draw up to 1.00 x full load amperes.
- A 1.15 service factor motor may draw up to 1.15 x full load amperes.
- 15% more current. *IT*. starters are current rated devices. In some cases, a larger *IT*. SSRV starter must be supplied for 1.15 SF motors. See the maximum horsepower chart below.

**Note:** Most motors used in industrial applications are 1.15 Service Factor (SF).

**Table 9. Replacement *IT*. Soft Start Units**

Service Factor	Horsepower	<i>IT</i> . Soft-Start Amperes	HMCP Amperes	Catalog Code	Service Voltage	Catalog Code	Control Voltage	Catalog Code	Space Options Inches (mm)	Catalog Code	
1.15	20	37	150	FT306A	480	E	120	A	18 (457.2) High	S	
	40	66		FT306B				B			
	60	105	250	FT306C				240	C		30 (762.0) High
	75	135		FT306D				380	D		
	125	180	400	FT306E				480	E		36 (914.4) High
	150	240		FT306F				575	F		
200	304	FT306G		—	—						

**Type W Replacement Starter Units**

**Table 10. Full Voltage Non-Reversing — Fusible ①**

NEMA Size	Maximum Horsepower					Fuse Clip Amperes	Catalog Code	Service Voltage	Catalog Code	Control Voltage	Catalog Code	Space Options Inches (mm)	Catalog Code
	208V	240V	380V	480V	600V								
1	7.5	7.5	10	10	10	30	FT204C	208 240 380 480 575	B C D E F	120 208 240 380 480 575	A B C D E F	12 (304.8) High 18 (457.2) High	S X
2	— 10	— 15	15 25	15 25	25 —	30 60	FT204E FT204F	208 240 380 480 575	B C D E F	120 208 240 380 480 575	A B C D E F	12 (304.8) High 18 (457.2) High	S X
3	— 25	20 30	30 50	40 50	50 —	60 100	FT204H FT204J	208 240 380 480 575	B C D E F	120 208 240 380 480 575	A B C D E F	24 (609.6) High	S
4	— 50	— 50	— 60	60 100	75 100	100 200	FT204L FT204M	208 240 380 480 575	B C D E F	120 208 240 380 480 575	A B C D E F	36 (914.4) High	S
5	50 100	60 100	100 150	150 200	150 200	200 400	FT204P FT204R	208 240 380 480 575	B C D E F	120 208 240 380 480 575	A B C D E F	54 (1371.6) High	S

① Fuse clip ratings shown are based on Class H fuses.

**Table 11. Full Voltage Reversing — Fusible ②**

NEMA Size	Maximum Horsepower					Fuse Clip Amperes	Catalog Code	Service Voltage	Catalog Code	Control Voltage	Catalog Code	Space Options Inches (mm)	Catalog Code
	208V	240V	380V	480V	600V								
1	7.5	7.5	10	10	10	30	FT214C	208 240 380 480 575	B C D E F	120 208 240 380 480 575	A B C D E F	18 (457.2) High 24 (609.6) High	S X
2	— 10	— 15	15 25	15 25	25 —	30 60	FT214E FT214F	208 240 380 480 575	B C D E F	120 208 240 380 480 575	A B C D E F	18 (457.2) High 24 (609.6) High	S X
3	— 25	20 30	30 50	40 50	50 —	60 100	FT214H FT214J	208 240 380 480 575	B C D E F	120 208 240 380 480 575	A B C D E F	36 (914.4) High	S
4	— 50	— 50	— 60	60 100	75 100	100 200	FT214L FT214M	208 240 380 480 575	B C D E F	120 208 240 380 480 575	A B C D E F	42 (1066.8) High	S

② Fuse clip ratings shown are based on Class H fuses.



## Type W Unit Options

Table 12. Option Groups ①

Groups	Description	Page Number
A	Advantage Options	10
B	Circuit Breaker Options	10
C	Control Power Source Options	10
G	Ground Fault Protection Options	10
M	Metering Options	11
O	Overload Options	11
P	Pilot Device Options	11
R	Relay and Timer (Control, Voltage, Current) Options	12
S	Starter Contact Options	12
SV	Vacuum Starter Options	12
T	Terminal Block Options	12
U	Unit Wiring Options	12

① Select your option suffix and attach it to the end of the catalog number.

Table 13. Option Suffix

Suffix	Description	Space Required ②
--------	-------------	------------------

### A — Advantage Options

A10	Substitute Advantage Starter Size 1	③
A11	Substitute Advantage Starter Size 2	③
A12	Substitute Advantage Starter Size 3	③
A13	Substitute Advantage Starter Size 4	③
A14	Substitute Advantage Starter Size 5	C ③④
A15	Advantage Hand/Off/Auto ACM for FVNR or RVNR Starters	C ④
A16	Advantage Stop/Start for FVNR or RVNR Starters	C ④
A17	Advantage Hand/Off/Auto-Start/Stop ACM for FVNR or RVNR Starters	C ④
A18	Advantage Fast/Slow/Stop 2-Speed Starters	C ④
A19	Advantage Forward/Reverse/Stop for Reversing Starters	C ④
A20	Advantage Fast/Slow/Off/Auto for 2-Speed Starters	C ④
A21	Advantage Forward/Reverse/Off/Auto for Reversing Starters	C ④
A22	ACM Metering Module	C ④
A23	WBELL Form C Bell Alarm Contact	C ④
A24	Reset with Overload Alarm and Trip Indication	C ④
A25	120V ac PLC Circuit Compatible Load Resistor	C ④
A26	WPONI PowerNet Communications Module	C ④
A27	Advantage Status Only ACM	C ④
A28	WPONIDNA DeviceNet Communications Module	C ④

### B — Breaker Options

B10	Shunt Trip 120V AC Wired to Terminal Blocks for Remote Tripping	C
B11	Auxiliary Switch Form C (1NO/1NC) Wired to Terminal Blocks	C
B12	Form C Bell Alarm Contact (1NO/1NC) Wired to Terminal Blocks	C
B13	Undervoltage Release	C
B14	IQ Energy Sentinel — F Frame	③
B15	IQ Energy Sentinel — J Frame	③
B16	IQ Energy Sentinel — K Frame	③
B17	IQ Central Energy Display	③
B18	Thermal Magnetic Circuit Breaker Instead of HMCP	—

### C — Control Power Source Options

C10	Control Fuse Wired for Separate Source in Lieu of Control Power Transformer	C
C11	Control Fuse with Disconnect for Separate Source in Lieu of Control Power Transformer	C
C12	Control Power Transformer 100 VA for Size 1 and 2 Starters (Fused)	C ④
C13	Control Power Transformer 150 VA for Size 3 and 4 Starters (Fused)	C
C14	Control Power Transformer 100 VA with Interposing Relay for Size 5 Starters, Fused	C
C15	Extra 50 VA for Control Power Transformer	S
C16	Extra 100 VA for Control Power Transformer	S
C17	Service Voltage Control, Fused in Lieu of Control Power Transformer	C
C18	Full Capacity Control Power Transformer for Size 5 Starters, Fused	C

### G — Ground Fault Protection Options

G10	Class 1 Ground Fault Protection — GRT1 Size 1 – 4	X
G11	Class 1 Ground Protection — GRT1 Size 5 – 6	X
G12	Ground Fault Test Panel	X

② Minimum unit size required (refer to Replacement Unit pages).

③ Consult factory for spacing.

④ Not available in 6 inches (152.4 mm).

## F10 Unitrol Unit Options

**Table 13. Option Suffix (Continued)**

Suffix	Description	Space Required <sup>①</sup>
<b>M — Metering Options</b>		
M10	Mini Voltmeter	C <sup>②</sup>
M11	Mini Ammeter with Current Transformer	S
M12	Mini Elapsed Time Meter	C <sup>②</sup>
M13	Current Transformer for Remote Metering	S
M14	Current Transducer 4-20 mA Output	X
<b>O — Overload Options</b>		
O10	IQ 500 Solid-State Overload Relay	—
O11	IQ 500 Load Protection Module	—
O16	Bell Alarm (1NO) Wired	C
O17	Bi-Metallic Overload Substitution	C
O18	Adjustable A200 Overload Substitution	C
O19	Overload Relay Heater/Heater Pack	C
O20	CEP7 Solid-State Overload Relay	C
<b>P — Pilot Device Options <sup>③</sup></b>		
P10	Red "RUN" Light	C
P11	Green "STOPPED" Light	C
P12	Amber "OVERLOAD TRIPPED" Light	C
P13	Green "RUN" Light	C
P14	Red "STOPPED" Light	C
P15	Red "RUN" Push-to-Test Light	C
P16	Green "STOPPED" Push-to-Test Light	C
P17	Amber "OVERLOAD TRIPPED" Push-to-Test Light	C
P18	Green "RUN" Push-to-Test Light	C
P19	Red "STOPPED" Push-to-Test Light	C
P20	Special Function Light	C
P30	"START" Pushbutton	C
P31	"STOP" Pushbutton	C
P32	"START/STOP" Pushbutton	C
P33	"ON" Pushbutton	C
P34	"OFF" Pushbutton	C
P35	"ON/OFF" Pushbutton	C
P36	"FORWARD/REVERSE/STOP" Pushbutton	C
P37	"FAST/SLOW/STOP" Pushbutton	C
P38	"FAST/OFF/SLOW" Pushbutton	C
P39	"HIGH/LOW/STOP" Pushbutton	C
P40	"HIGH/LOW/OFF" Pushbutton	C
P41	Special Function Pushbutton	C
P50	"ON-OFF" Selector Switch	C
P51	"HIGH-LOW" Selector Switch	C
P52	"OFF-AUTO" Selector Switch	C
P53	"START-STOP" Selector Switch	C
P54	"SLOW-FAST" Selector Switch	C
P55	"FORWARD-REVERSE" Selector Switch	C
P56	Special Function 2-Position Selector Switch	C
P57	"HAND-OFF-AUTO" Selector Switch	C
P58	"LOCAL-OFF-REMOTE" Selector Switch	C
P59	"FAST-OFF-SLOW" Selector Switch	C
P60	"HIGH-OFF-LOW" Selector Switch	C
P61	Special Function 3-Position Selector Switch	C
P62	"HIGH-LOW-OFF-AUTO" Selector Switch	C
P63	Special Function 4-Position Selector Switch	C

<sup>①</sup> Minimum unit size required (refer to Replacement Unit pages).

<sup>②</sup> Customer to supply range of meter required.

<sup>③</sup> Available only with F2100, Advantage, Series 2100/5 Star, Freedom Unitrol, F10 Unitrol and Type W. Consult factory for specific size limitations.

## F10 Unitrol Unit Options

Table 13. Option Suffix (Continued)

Suffix	Description	Space Required <sup>①</sup>						
<b>R — Relay and Timer Options</b>								
R10	Auxiliary Control Relay 2-Pole (1NO/1NC) Convertible Contacts Wired in Parallel with Starter Coil	S						
R11	Auxiliary Control Relay 4-Pole (2NO/2NC) Convertible Contacts Wired in Parallel with Starter Coil	S						
R12	Auxiliary Control Relay 2-Pole Overload Alarm (1NO/1NC) Convertible Contacts	S						
R13	Mechanical Latching Relay (Specify Connection)	X						
R14	Ice Cube Relay 300 Volts 3-Pole Blade Type (Specify Connection)	S						
R15	Phase Voltage Relay	X						
R16	Current Sensing Relay with Contacts Wired to Terminal Blocks	X						
R17	Deceleration Timing Relay (Pneumatic "OFF" Delay)	S						
R18	Compelling Timing Relay (Pneumatic "ON" Delay)	S						
R19	Time Clock 24 Hour	②						
R20	Time Clock 7 Day	②						
R21	Solid-State Timer Type TR (Specify Connection)	S						
R22	DN65 DeviceNet Interface Module	S						
R23	D15 2-Pole Control Relay	C						
R24	D15 4-Pole Control Relay	C						
<b>S — Starter Contact Options (Maximum of 8 Contacts)</b>								
S__	To order extra starter contacts, you must specify the number of NO/NC contacts, given a maximum of eight (8). To define the unit option required, create a suffix based on the following example:							
	<table border="1"> <thead> <tr> <th></th> <th>Quantity of Normally Open Contacts</th> <th>Quantity of Normally Closed Contacts</th> </tr> </thead> <tbody> <tr> <td>S</td> <td>2</td> <td>3</td> </tr> </tbody> </table>		Quantity of Normally Open Contacts	Quantity of Normally Closed Contacts	S	2	3	
	Quantity of Normally Open Contacts	Quantity of Normally Closed Contacts						
S	2	3						
<b>SV — Vacuum Starter Options</b>								
SV4	Vacuum Starter Size 4 Substitution FVNR	②						
SV5	Vacuum Starter Size 5 Substitution FVNR	②						
SV6	Constant Horsepower Instead of Constant/Variable Torque	—						
<b>T — Terminal Block Options</b>								
T10	Pull-apart Type Terminal Blocks (Standard on all Vintages Except Type W and 11-300)	S						
T11	Utility Screw Type Terminal Blocks (Add 6 Inches (152.4 mm) for Every 18 Points)	—						
T12	Front-mounted Pull-apart Terminal Block for F2100, Advantage, Series 2100/5 Star	S						
T13	T-Lead Power Terminal Blocks for Size 1 Starter	—						
<b>U — Unit Wiring Options</b>								
U10	Surge Suppressor on Coil	C						
U11	Type SIS Control Wire	C						
U12	Type SIS Power Wire	C						
U13	Type 14 Gauge Control Wire (Standard for all Vintages Except F2100, Series 2100/5 Star, Type W and 11-300)	C						
U14	Wiremarkers — Sleeve Type on all Control Wire	C						
U15	Locking Fork Terminals on all Control Wiring	S						
U16	Ring Wire Terminals on Power Wiring	S						
U17	Wiring Diagram Inside Starter Unit Door	C						
U18	Pre-insulated Ring Terminals on all Control Wiring	C						
U19	Pre-insulated Ring Terminals on all Control Wiring, except for Freedom Starter Terminals	C						
U20	Wiremarkers for Power Wiring	C						

① Minimum unit size required (refer to Replacement Unit pages).

② Consult factory for spacing.

**Type W Structure Parts**

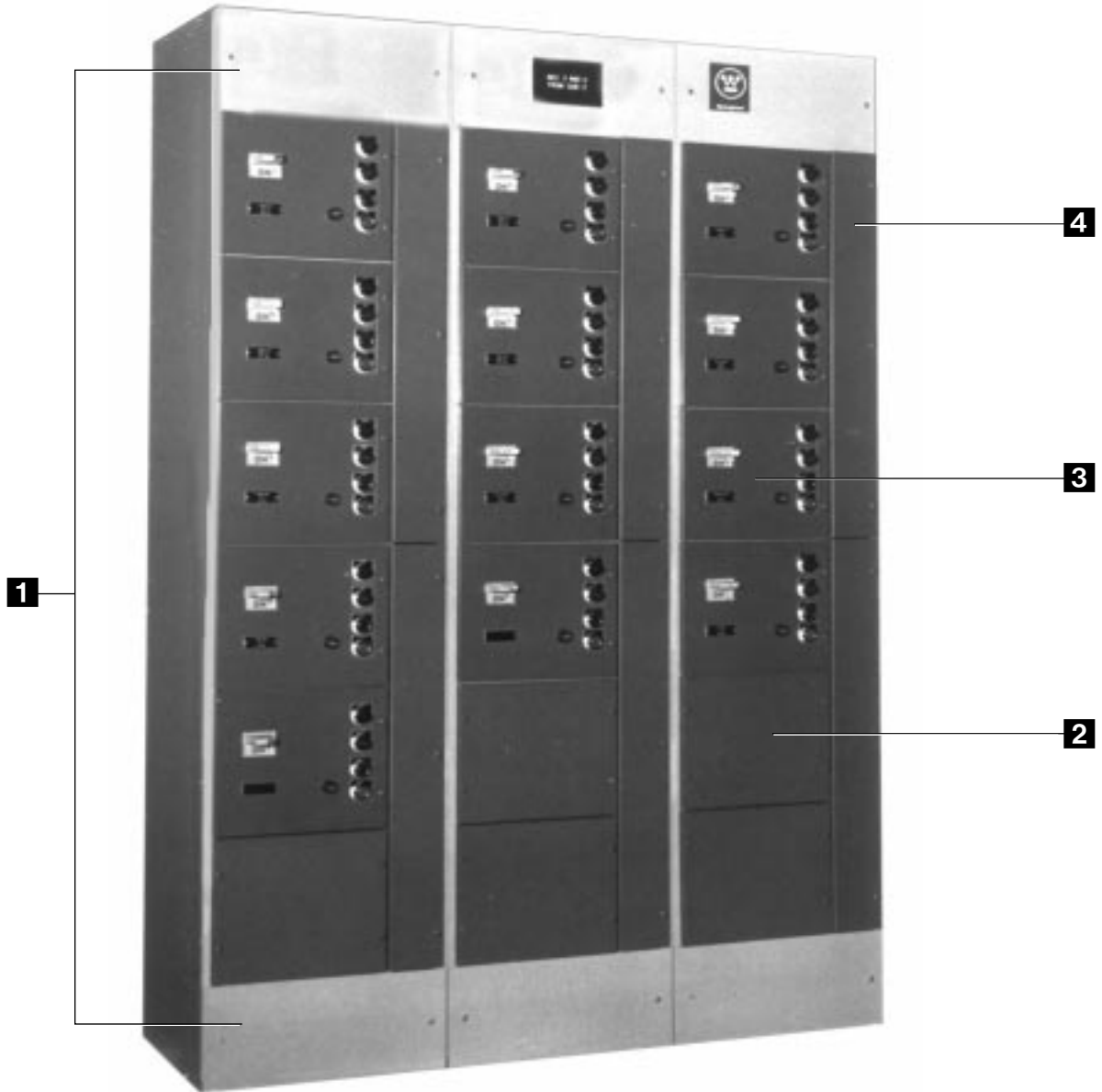

**Table 14. Structure Parts**

Reference	Description	Page
<b>1</b>	Top/Bottom Front Plate	14
<b>2</b>	Blank Unit Door	14
<b>3</b>	Unit Starter Door Door Mounting Hardware	14 14
<b>4</b>	Vertical Wireway Door	15

Reference	Description	Page
<b>4</b>	Horizontal and Vertical Bus Insulator	15
	Vertical Bus Barrier	16
	Divider Pan/Guide Rail	16
	Horizontal Bus Splice	15
	Horizontal Bus Bar Assemblies	14
	Vertical Bus Bar Assemblies	16

**Type W Structure Parts**

**Top/Bottom Front Plate 1**



Top/Bottom Front Plate

**Table 15. Top/Bottom Front Plate**

Dimensions in Inches (mm)		Style Number
Height	Width	
19 (482.6)	9 (228.6)	112C418H01

**Blank Unit Door with Mounting Hardware 2**



Blank Unit Door with Mounting Hardware

**Table 16. Blank Unit Door with Mounting Hardware**

Dimensions in Inches (mm)		Style Number
Height	Width	
6 (152.4)	13-3/8 (339.7)	4719A93G27
12 (304.8)	13-3/8 (339.7)	4719A93G28
18 (457.2)	13-3/8 (339.7)	4719A93G29

**Door Mounting Hardware Kit 3**



Door Mounting Hardware Kit

**Table 17. Door Mounting Hardware Kit**

Description	Style Number
Kit includes 2 hinges, (2) 1/4 turn latches, (2) 1/4 turn screws and mounting hardware.	4719A93G22

**Unit Starter Door Kit 3**

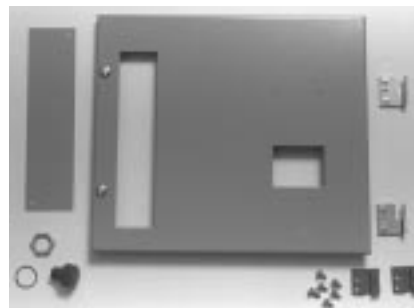

Unit Starter Door Kit

**Table 18. Unit Starter Door Kit**

Description	NEMA Size	Door Size Height Inches (mm)	Disconnect Type	Style Number
Kit includes door with disconnect and device panel cutouts, reset button cutout with plug, and mounting hardware.	1 or 2	12 (304.8)	HMCP, MCP, FB, HFB	4719A93G01
	1 or 2	18 (457.2)	HMCP, MCP, FB, HFB	4719A93G02
	1 or 2	18 (457.2)	HFD, FB, TRI-PAC	4719A93G03
	3	18 (457.2)	HMCP, MCP, FB, HFB, HFD	4719A93G04
	3	24 (609.6)	FB TRI-PAC	4719A93G05
	1 or 2	12 (304.8)	DS Switch	4719A93G06
1 or 2	18 (457.2)	DS Switch	4719A93G07	
3	24 (609.6)	DS Switch	4719A93G08	
—	12 (304.8)	Dual FB	4719A93G19	
—	12 (304.8)	Dual DS Switch	4719A93G20	

**Horizontal Bus Bar Assemblies 4**



Horizontal Bus Bar

**Table 19. Horizontal Bus Bar Assemblies ①**

Horizontal Bus Amperes	Structure Width Inches (mm)	Bus Bar Size Inches (mm)	Style Number
<b>Aluminum</b>			
600	19 (482.6)	1/4 x 2 (6.4 x 50.8)	4719A93G31
600	32-1/2 (825.5)	1/4 x 2 (6.4 x 50.8)	4719A93G32
800	19 (482.6)	1/4 x 3 (6.4 x 76.2)	4719A93G33
800	32-1/2 (825.5)	1/4 x 3 (6.4 x 76.2)	4719A93G34
1000	19 (482.6)	1/4 x 4 (6.4 x 101.6)	4719A93G35
1000	32-1/2 (825.5)	1/4 x 4 (6.4 x 101.6)	4719A93G36
<b>Copper</b>			
600	19 (482.6)	1/4 x 2 (6.4 x 50.8)	4719A93G37
600	32-1/2 (825.5)	1/4 x 2 (6.4 x 50.8)	4719A93G38
800	19 (482.6)	1/4 x 3 (6.4 x 76.2)	4719A93G39
800	32-1/2 (825.5)	1/4 x 3 (6.4 x 76.2)	4719A93G40
1000	19 (482.6)	1/4 x 4 (6.4 x 101.6)	4719A93G41
1000	32-1/2 (825.5)	1/4 x 4 (6.4 x 101.6)	4719A93G42

① 22,000A rms bus bracing.

**Type W Structure Parts**

**Horizontal and Vertical Bus Insulator Kit 4**



*Horizontal Bus Insulator Kit*

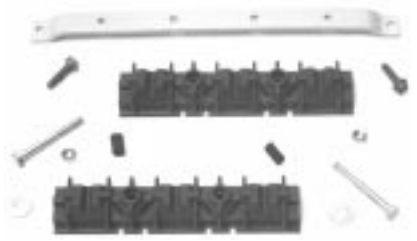

*Vertical Bus Insulator Kit*

**Table 20. Horizontal and Vertical Bus Insulator Kit**

Description	Style Number
Kit includes horizontal and vertical bus supports and mounting hardware.	<b>4719A93G09</b>

**Vertical Wireway Door 4**



*Vertical Wireway Door*

**Table 21. Vertical Wireway Door**

Description	Style Number
4-1/2 inches (143.3 mm) wide x 36 inches (914.4 mm) high door with mounting hardware.	<b>4719A93G25</b>

**Horizontal Bus Splice Kit 4**



*Horizontal Bus Splice Kit*

**Table 22. Horizontal Bus Splice Kit**

Description	Bus Ampere Rating		Bus Size Inches (mm)	Style Number
	NEMA	UL		
Kit includes silver plated copper bus splice plates with mounting hardware.	600	—	1/4 x 1-1/2 (6.4 x 38.1)	<b>4719A93G51</b>
	800	—	1/4 x 2 (6.4 x 50.8)	<b>4719A93G52</b>
	—	800	1/4 x 3 (6.4 x 76.2)	<b>4719A93G53</b>
	—	1000	1/4 x 4 (6.4 x 101.6)	<b>4719A93G54</b>

Vertical Bus Barrier Kit 4

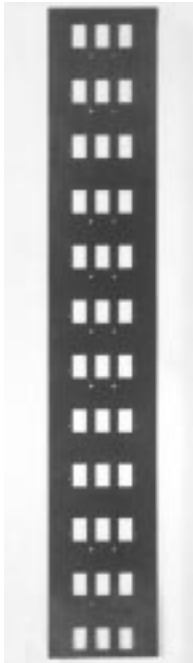

Vertical Bus Barrier Kit

Table 23. Vertical Bus Barrier Kit

Description	Style Number
Kit includes barrier, 12 stab cutouts, and 24 clips.	4719A93G10

Vertical Bus Bar Assemblies 4



Vertical Bus Bar Assemblies

Table 24. Vertical Bus Bar Assemblies ①

Vertical Bus Amperes	Structure Type	Style Number
<b>Copper</b>		
300	Front	4719A93G45
600	Front	4719A93G47
500	Back-to-Back	4719A93G46

① 22,000A rms bus bracing.

Divider Pan/Guide Rail Kit 4



Divider Pan/Guide Rail Kit

Table 25. Divider Pan/Guide Rail Kit

Description	Style Number
Kit includes pan, guide rails and mounting hardware.	4719A93G11

**Type W Unit Parts**

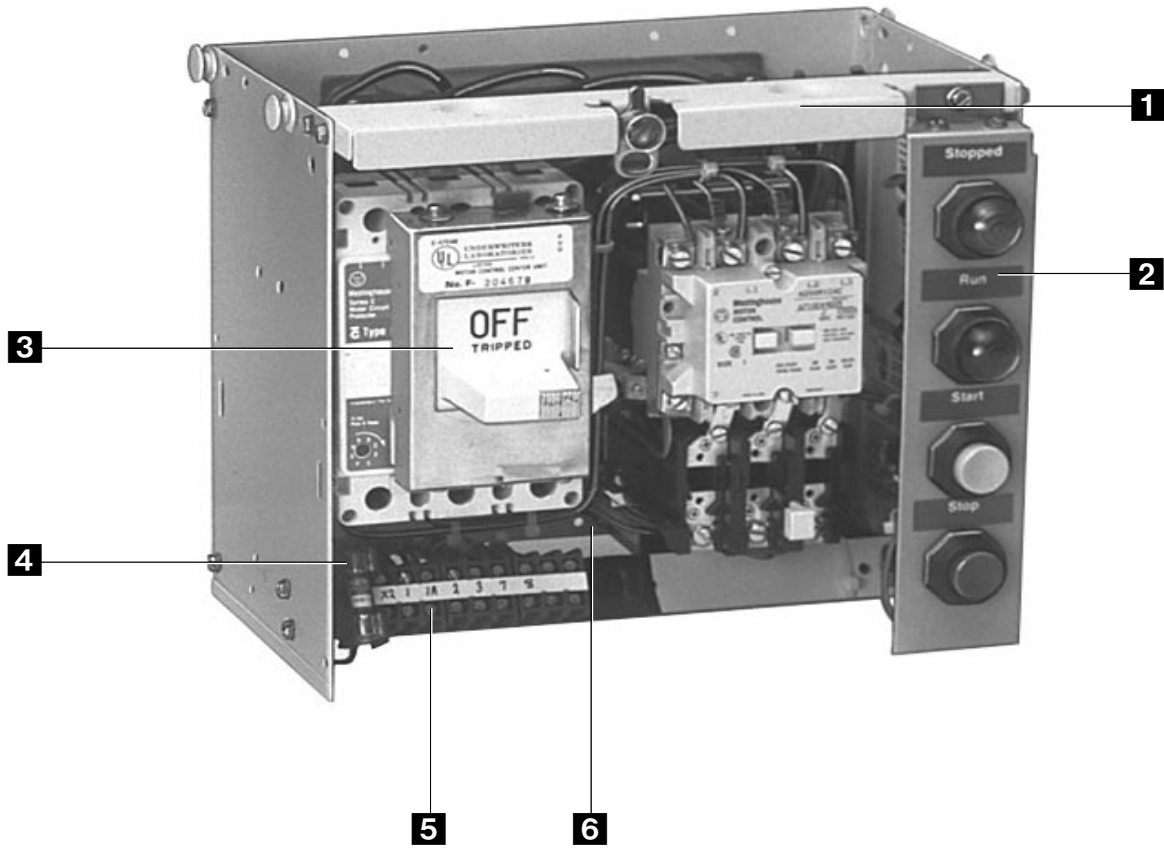

**Table 26. Unit Parts**

Reference	Description	Page
<b>1</b>	Unit Top Rail	18
<b>2</b>	Device Panel	18
<b>3</b>	Operating Handle Mechanism	18
<b>4</b>	Fuse Holder	18
<b>5</b>	Terminal Blocks	18

Reference	Description	Page
<b>6</b>	Terminal Block Mounting Rail	19
	Control Transformer	19
	Fuse Clip	19
	Overload Reset Button and Reset Rod Ext.	19
	Single to Dual Mounting Feeder Breaker	19



**Type W Unit Parts**

**Unit Top Rail with Mounting Hardware 1**



*Unit Top Rail with Mounting Hardware*

**Table 27. Unit Top Rail with Mounting Hardware**

Description	Style Number
Unit Top Rail with mounting hardware.	4719A94G32

**Device Panel with Mounting Hardware 2**



*Device Panel with Mounting Hardware*

**Table 28. Device Panel with Mounting Hardware**

Description	Style Number
Four (4) Knockouts, 12-inch (304.8 mm) Unit	4719A94G01
Five (5) Knockouts, 18-inch (457.2 mm) Unit	4719A94G02

**Fuse Holder 4**



*Fuse Holder*

**Table 29. Fuse Holder**

Description	Style Number
Fuse Holder	NDNF1-WH

**Terminal Blocks 5**

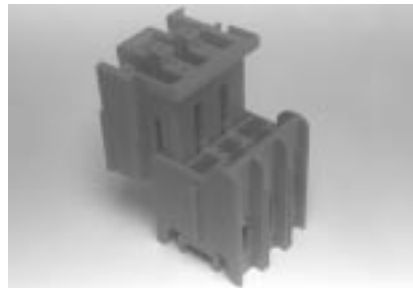

*Pull-Apart Terminal Block*



*Pressure Terminal Block*

**Table 30. Terminal Blocks**

Description	Style Number
White, (3) Circuit, Pressure	4719A94G11
White, (3) Circuit, Pull-apart	4719A94G12

**Operating Handle Mechanism 3**



*Operating Handle Mechanism*

**Table 31. Operating Handle Mechanism**

Description	Style Number
<b>Circuit Breaker</b>	
HMCP/HFD/MCP/FB	4719A94G03
HJD/KB/MCP250	4719A94G04
LA/MCP400	4719A94G05
MA	4719A94G06
NB	4719A94G07
<b>Fusible Switch</b>	
30/60/100 Ampere DS Switch	4719A94G08
200 Ampere DS Switch	4719A94G09

**Type W Unit Parts**

**Terminal Block Mounting Rail** 

**Table 32. Terminal Block Mounting Rail**

Description	Style Number
Mounting Rail	4719A94G14

**Single to Dual Mounting Feeder Breaker Kit** 

**Table 33. Single to Dual Mounting Feeder Breaker Kit**

Description	Style Number
Feeder Breaker Kit	4719A94G18

**Control Transformer  
(480/240V to 120V Single-Phase)** 

**Table 34. Control Transformer  
(480/240V to 120V Single-Phase)**

Description	Style Number
50 VA	4719A92G46
100 VA	4719A92G48
150 VA	4719A92G49
200 VA	4719A92G50
250 VA	4719A92G51
300 VA	4719A92G52
350 VA	4719A92G53
500 VA	4719A92G54

**Fuse Clip Kit** 



*Fuse Clip Kit*

**Table 35. Fuse Clip Kit** <sup>①</sup>

Description	Amperes	Style Number
Kit includes line and load blocks with clips.	30A Non-rejection	4719A94G22
	60A Non-rejection	4719A94G24
	100A Non-rejection	4719A94G26
	200A Non-rejection	4719A94G28
	400A Non-rejection	4719A94G30

<sup>①</sup> For use with DS Type switch.

**Overload Reset Button and Reset Rod Extension Kit** 



*Overload Reset Button and Reset Rod Extension Kit*

**Table 36. Overload Reset Button and Reset Rod Extension Kit**

Description	Style Number
Kit includes reset button, extension rod and "O" ring.	4719A92G04

**Series C Retrofit Kits**

Series C Retrofit Kits are to be used to upgrade existing Type W and 5 Star Motor Control Center buckets by changing out the old breakers with the Series C. These kits can be applied to both starter and feeder units.

The old breakers that these kits will upgrade include, but are not limited to, the MCP, F, FA, FB, HFB, K, KA, KB, HKB, L, LA, LB and HLB breakers.

**5 Star Series C Retrofit Kit**



*5 Star Series C Retrofit Kit*

The 5 Star Series C Retrofit Kit includes:

- Series C device, 65 kA (either HMCP or thermal-magnetic breaker).
- Operating handle mechanism, including tripped indication and push-to-trip.
- Label stating that the MCC unit has been retrofitted with Series C device suitable for 65 kA (similar to UL quality label).
- Templates for desired frame size.
- Assembly instructions.

**Type W Series C Retrofit Kit**

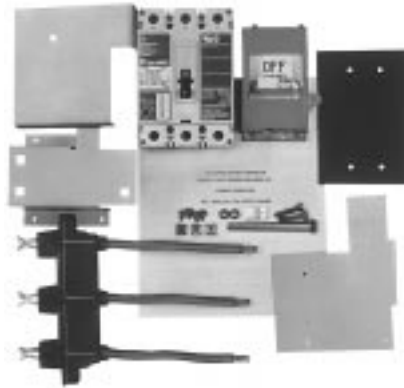

*Type W Series C Retrofit Kit*

The Type W Series C Retrofit Kit includes:

- Series C device, 65 kA (either HMCP or thermal-magnetic breaker).
- Operating handle mechanism, including tripped indication and push-to-trip.
- Label stating that the MCC unit has been retrofitted with Series C device suitable for 65 kA (similar to UL quality label).
- Templates for proper hole placement for desired frame size.
- Series C breaker mounting hardware.
- New door and hardware.
- New stab assembly.
- Assembly instructions.

**F10 Series C Retrofit Kit**



*F10 Series C Retrofit Kit*

The F10 Series C Retrofit Kit includes:

- Series C device, 65 kA (either HMCP or thermal-magnetic breaker).
- Operating handle mechanism, including tripped indication push-to-trip.
- Label stating that the MCC unit has been retrofitted with Series C device suitable for 65 kA (similar to UL quality label).
- Templates for desired frame size.
- Assembly instructions.

**How to Order**

1. Select the correct Series C device from the table in the applicable RPD  
 5 Star — RP04304003E  
 Type W — RP04304006E  
 F10 — RP04304005E
2. Create a catalog number based on the MCC Type, Device Selected, Modification, Door Size and Device Panel.

Select price from PL04304002E.

**Table 37. Series C Retrofits, Catalog Numbering System**

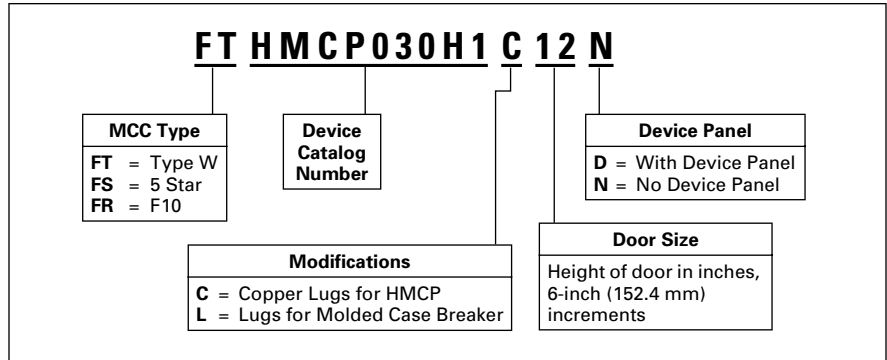

**Table 38. Series 2100/5-Star Series C Breaker Retrofit Upgrade Kit**

Catalog Number	Catalog Number	Catalog Number	Catalog Number	Catalog Number
FTHMCP003A0	FTHMCP250D5	FTHMCP400X5	FTFDC3020	FTHJD3250
FTHMCP007C0	FTHMCP250F5	FTHFD3015	FTFDC3025	FTJDC3175
FTHMCP015E0	FTHMCP250G5	FTHFD3020	FTFDC3030	FTJDC3200
FTHMCP025D0	FTHMCP250J5	FTHFD3025	FTFDC3040	FTJDC3225
FTHMCP030H1	FTHMCP250K5	FTHFD3030	FTFDC3050	FTJDC3250
FTHMCP050G2	FTHMCP250L5	FTHFD3040	FTFDC3060	FTHKD3300
FTHMCP050K2	FTHMCP250W5	FTHFD3050	FTFDC3070	FTHKD3350
FTHMCP070J2	FTHMCP400D5	FTHFD3060	FTFDC3080	FTHKD3400
FTHMCP070M2	FTHMCP400F5	FTHFD3070	FTFDC3090	FTKDC3300
FTHMCP100L3	FTHMCP400G5	FTHFD3080	FTFDC3100	FTKDC3350
FTHMCP100R3	FTHMCP400J5	FTHFD3090	FTFDC3125	FTKDC3400
FTHMCP150T4	FTHMCP400K5	FTHFD3100	FTFDC3150	—
FTHMCP150U4	FTHMCP400L5	FTHFD3125	FTHJD3175	—
FTHMCP250A5	FTHMCP400W5	FTHFD3150	FTHJD3200	—
FTHMCP250C5	FTHMCP400R5	FTFDC3015	FTHJD3225	—

**Note:** Entire catalog number is not listed above and will not affect price.

### How to Create a Catalog Number

After selecting the circuit device required, create a **Dual Mounted** feeder unit catalog number based on the following:

**Note:** Catalog number varies in length based on single or dual mounted unit.

**Table 39. Catalog Numbering System Example**

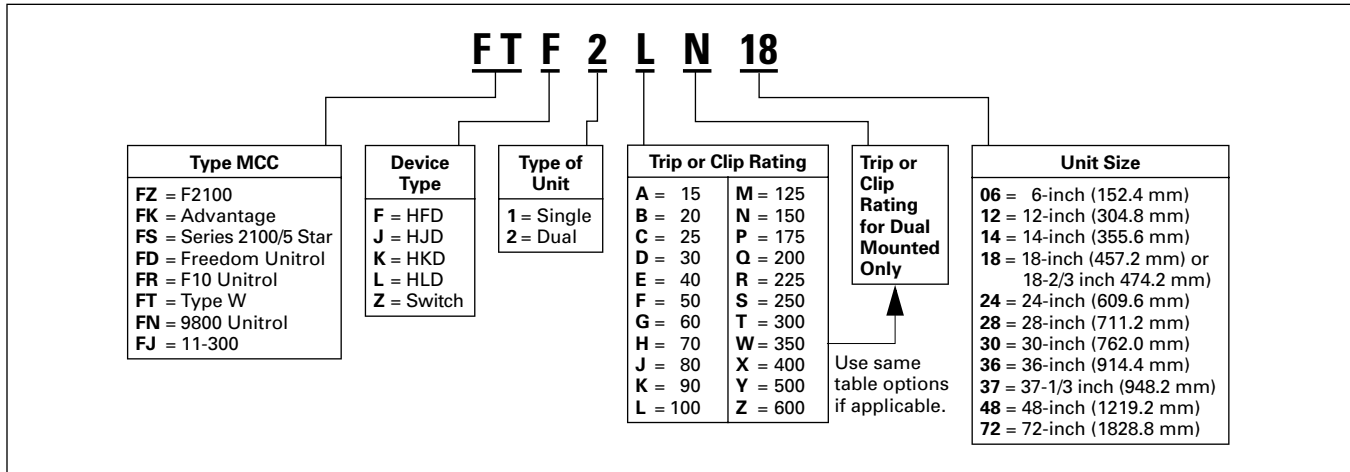

**Replacement Feeder Units**

**Product Description**

Each Feeder Unit consists of a single-mounted 3-pole molded case circuit breaker or fusible switch (dual mounted are also available). Each unit includes a new wrapper, stab assembly, door, handle mechanism and customer specific disconnect device. They are shipped assembled and ready to install into the existing motor control center.

The following are simple steps to select and order a new feeder unit:

**Step 1**

Select the circuit device required from **Table 40** below.

**Step 2**

Verify the amount of space available.

**Step 3**

Create a catalog number using **Table 38** on **Page 21**.

**Unit options and modifications for replacement feeder units:**

For factory installed molded case circuit breaker modifications or additional unit options, contact the factory for prices and availability.

**Table 40. Electrical Characteristics and Space Requirements of Molded Case Circuit Breakers and Fusible Switch Replacement Feeder Units — Inches (mm)**

Device Type	Maximum Amperes	Interrupting Rating (kAIC)			Trip Rating or Clip	Freedom 2100 Series 2100/5 Star Advantage		Freedom Unitrol		F10		Type W		9800		11-300				
		240V	480V	600V		Single	Dual	Single	Dual <sup>①</sup>	Single	Dual <sup>①</sup>	Single	Dual	Single	Dual <sup>①</sup>	Single	Dual			
HFD	150	100	65	25	15															
					20															
					25															
					30															
					40															
					50															
					60															
70																				
					80	6 <sup>②</sup> (152.4)		6 <sup>②</sup> (152.4)												
					90	12 <sup>③</sup> (304.8)	12 (304.8)	12 <sup>③</sup> (304.8)	12 (304.8)	12 <sup>③</sup> (304.8)	12 (304.8)	12 <sup>③</sup> (304.8)	12 (304.8)	14 (355.6)	14 (355.6)	14 (355.6)	14 (355.6)			
					100															
					125	12 (304.8)	12 (304.8)	12 (304.8)	18 (457.2)	12 (304.8)	18 (457.2)	12 (304.8)	12 (304.8)	14 (355.6)	18 (457.2)	14 (355.6)	14 (355.6)			
					150	12 <sup>③</sup> (304.8)						12 <sup>③</sup> (304.8)								
HJD	250	100	65	25	175															
					200															
					225	18 (457.2)		24 (609.6)		18 (457.2)		18 (457.2)		18 (457.2)		14 (355.6)				
					250															
HKD	400	100	65	35	300															
					350															
					400	24 (609.6)		24 <sup>④</sup> (609.6)		24 <sup>④</sup> (609.6)		24 (609.6)		28 <sup>④</sup> (711.2)		14 (355.6)				
HLD	600	100	65	35	500															
					600	24 (609.6)		24 <sup>④</sup> (609.6)		24 <sup>④</sup> (609.6)										
Fusible Switch	30	100	100	100	30	12 (304.8)	12 <sup>③</sup> (304.8)	12 (304.8)	18 (457.2)	12 (304.8)	18 (457.2)	12 (304.8)	12 <sup>③</sup> (304.8)	14 (355.6)	18 (457.2)	14 (355.6)	14 (355.6)			
	60	100	100	100	60	12 (304.8)	12 <sup>③</sup> (304.8)	12 (304.8)	18 (457.2)	18 (457.2)	18 (457.2)	12 (304.8)	12 <sup>③</sup> (304.8)	14 (355.6)	18 (457.2)	14 (355.6)	14 (355.6)			
	100	100	100	100	100	18 (457.2)		18 (457.2)		18 (457.2)		12 <sup>③</sup> (304.8)		18 (457.2)		18 (457.2)	18-2/3 (474.2)			
	200	100	100	100	200	36 (914.4)		30 (762.0)		30 (762.0)		24 (609.6)		28 (711.2)		28 (711.2)				
	400	100	100	100	400	36 (914.4)		72 <sup>④</sup> (1828.8)		48 <sup>④</sup> (1219.2)		42 (1066.8)		42 <sup>④</sup> (1066.8)		42 (1066.8)				
	600	100	100	100	600	48 (1219.2)		72 <sup>④</sup> (1828.8)												

① Combined ampacity no greater than 150A for 12-inch (304.8 mm) height. For greater than 150A, 18-inch (457.2 mm) required.

② 100A maximum.

③ Available in 18-inch (457.2 mm) height.

④ Cable in/cable out, no stab assembly.

NEMA is the registered trademark and service mark of the National Electrical Manufacturers Association. UL is a registered trademark of Underwriters Laboratories Inc.

Eaton Corporation  
Cutler-Hammer business unit  
1000 Cherrington Parkway  
Moon Township, PA 15108-4312  
USA  
tel: 1-800-525-2000  
[www.cutler-hammer.eaton.com](http://www.cutler-hammer.eaton.com)