

V800 Combination Gas Controls for Heating Appliances

PRODUCT DATA

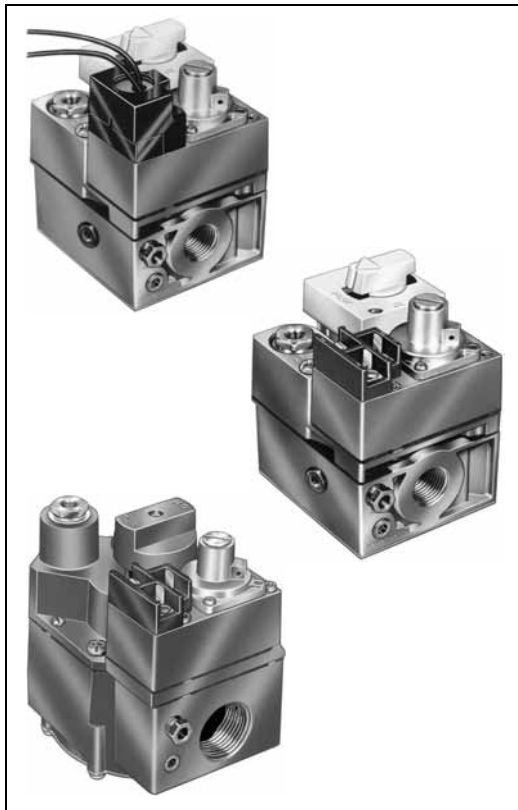

FEATURES

- Available in 7 capacity ratings.
- Suitable for use on domestic equipment from small individual room heaters to large central heating units.
- Provides 3-position (OFF-PILOT-ON) manual control of gas flow.
- Available in standard opening and step opening pressure regulator models.
- Can be mounted from 0 to 90 degrees from the vertical position of the gas control knob.
- Controls with the prefix "V" require 30 mV thermocouple and suitable pilot burner.
- Controls with the prefix "VS" require 750 mV thermopile generator in a self-generating Powerpile system.
- If gas or power supply is interrupted, main gas valve is closed.
- In case of pilot flame failure, main valve is closed.

APPLICATION

The V800 family of Combination Gas Controls performs all the functions required in the burner manifold on gas-fired heating equipment.

Contents

Application	1
Features	1
Specifications	2
Ordering Information	2
Installation	5
Wiring	7
Startup And Checkout	9
Maintenance	11
Operation	11
Service	13
Instructions to the Appliance Owner	13



SPECIFICATIONS

IMPORTANT

The specifications given in this publication do not include normal manufacturing tolerances. Therefore, this unit may not match the listed specifications exactly. Also, this product is tested and calibrated under closely controlled conditions, and some minor differences in performance can be expected if those conditions are changed.

SUPER TRADELINE/TRADELINE MODELS:

SUPER TRADELINE controls offer features not available on TRADELINE or standard models, and are designed to replace a wide range of Honeywell and competitive controls.

TRADELINE models are selected and packaged to provide ease of stocking, ease of handling and maximum replacement value. Specifications of SUPER TRADELINE and TRADELINE controls are the same as those of standard models except as noted below

SUPER TRADELINE MODELS:

V800A Combination Gas Control and VS820A Combination Gas Control with Powerpile with 3/4 in. inlet, 3/4 in. straight through outlet, and 1/2 in. left-hand and right-hand side outlets.

TRADELINE MODELS:

V400A, V800A,C, and VS820A,C Combination Gas Control with either 1/2 in. left-hand or right-hand side outlet.

Additional Features:

Left and right side outlets in addition to the straight-through outlet. Refer to Fig. 3.

Ambient Temperature Range: Models available for 32° to 175° F (0° to 79° C).

Reducer fittings included to fit variety of sizes.

TRADELINE pack with cross reference label and special instruction sheet.

Standard Models:

Models: Refer to Table 1 for model specifications.

V400—120V combination gas control with magnetic type operator.

V800—24V combination gas control with magnetic type operator.

V801—24V combination gas control with magnetic type operator.

VS820, VS821—Millivoltage combination gas control with Powerpile operator.

ORDERING INFORMATION

When purchasing replacement and modernization products from your TRADELINE® wholesaler or distributor, refer to the TRADELINE® Catalog or price sheets for complete ordering number.

If you have additional questions, need further information, or would like to comment on our products or services, please write or phone:

1. Your local Honeywell Automation and Control Products Sales Office (check white pages of your phone directory).
2. Honeywell Customer Care
1885 Douglas Drive North
Minneapolis, Minnesota 55422-4386

In Canada—Honeywell Limited/Honeywell Limitée, 35 Dynamic Drive, Toronto, Ontario M1V 4Z9.

International Sales and Service Offices in all principal cities of the world. Manufacturing in Australia, Canada, Finland, France, Germany, Japan, Mexico, Netherlands, Spain, Taiwan, United Kingdom, U.S.A.

Table 1. Model Specifications.

Model No. Suffix Letter	Ambient Temperature Range	Pressure Regulator Type	Pressure Regulator Model	Type of Gas	Standard Factory Setting	
					in. wc	kPa
A	32° to 175° F (0° to 79° C)	Standard	V5306	Nat.	3.5	0.9
				LP	11.0	2.7
C	32° to 175° F (0° to 79° C)	Step-opening	V5307	Nat.	0.9 step 3.5 full rate	0.2 step 0.9 full rate
				LP	2.2 step 11.0 full rate	0.5 step 2.7 full rate
H	32° to 175° F (0° to 79° C)	Standard (Delayed opening)	V5306	Nat.	3.5	0.9
				LP	11.0	2.7
M	-40° to 175° F (-40° to 79° C)	Standard	V5306	Nat.	3.5	0.9
				LP	11.0	2.7
P	-40° to 175° F (-40° to 79° C)	Step-opening	V5307	Nat.	0.9 step 3.5 full rate	0.2 step 0.9 full rate
				LP	2.2 step 11.0 full rate	0.5 step 2.7 full rate

Capacities and Pipe Sizes: See Table 2 for capacity and pipe sizes. Capacity is the same with or without the pressure regulator.

Table 2. Capacities and Pipe Sizes^a.

Inlet Outlet Size	Capacity ^b cfh	Capacity ^b m ³ /hr	Model Number
1/2 x 3/8	110	3.1	V801, VS821
1/2 x 1/2	225	5.1	V400, V800, V810, VS820
1/2 x 3/4	250	5.8	
3/4 x 3/4	335	5.9	
3/4 x 3/4	450	12.7	High Capacity
3/4 x 1	503	14.2	V400, V800, V810, VS820
1 x 1	600	17.0	

^a All models have leak limit orifice.

^b Capacities are based on 1000 BTU/ft³, 0.64 specific gravity natural gas at 1 in. wc p.c. (37.3 MJ/m³, 0.64 specific gravity natural gas at 0.25 kPa p.d.). Use conversion factors (in Conversion factors table) to convert to other gases.

Conversion Factors:

Gas	Specific Gravity	Multiply Listed Capacity By
Manufactured	0.60	0.516
Mixed	0.70	0.765
Propane	1.53	1.62

Electrical Connections:

Valve Operator	Type Connection
100V, 120V, and 220/240V	36 in. (0.91 m) leadwires (2)
24V and Powerpile	Combination screw and quick-connect (1/4 in. male)

Thermostat Heat Anticipator Setting:

24V Models: 0.2A.
100V, 120V, 220/240V
Powerpile Models: Not applicable.

Pilot Gas Outlet: Compression fitting for 1/4 in. OD tubing.

Pressure Tapping:

Taps are 1/8 in. NPT with plug containing recess for 3/16 in. Allen wrench. Outlet tap standard, inlet tap available; specify when ordering.

Pressure Rating:

A.G.A. rating 1/2 psi (3.5 kPa) inlet pressure. Designed for safe operation up to 28 in. wc (7.0 kPa).

Mounting:

All models can be mounted from 0 to 90 degrees from the vertical position of the gas control knob.

Dimensions: Refer to Figures 1 and 2.

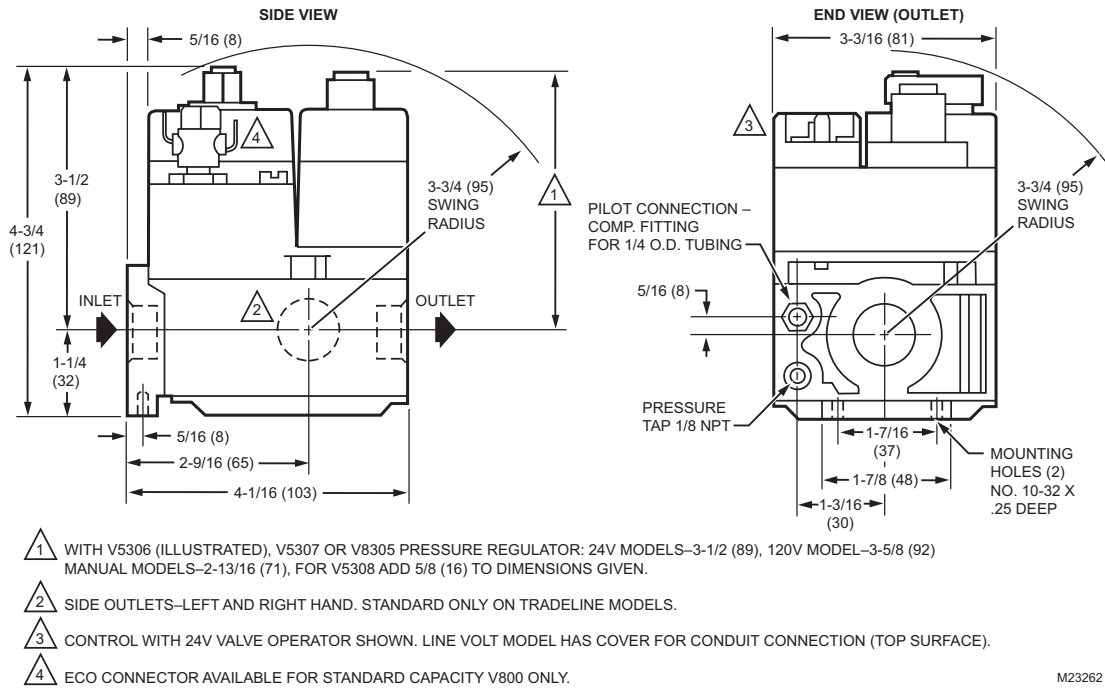

Fig. 1. V800 Family Combination Gas Controls Installation Dimensions in inches (mm).

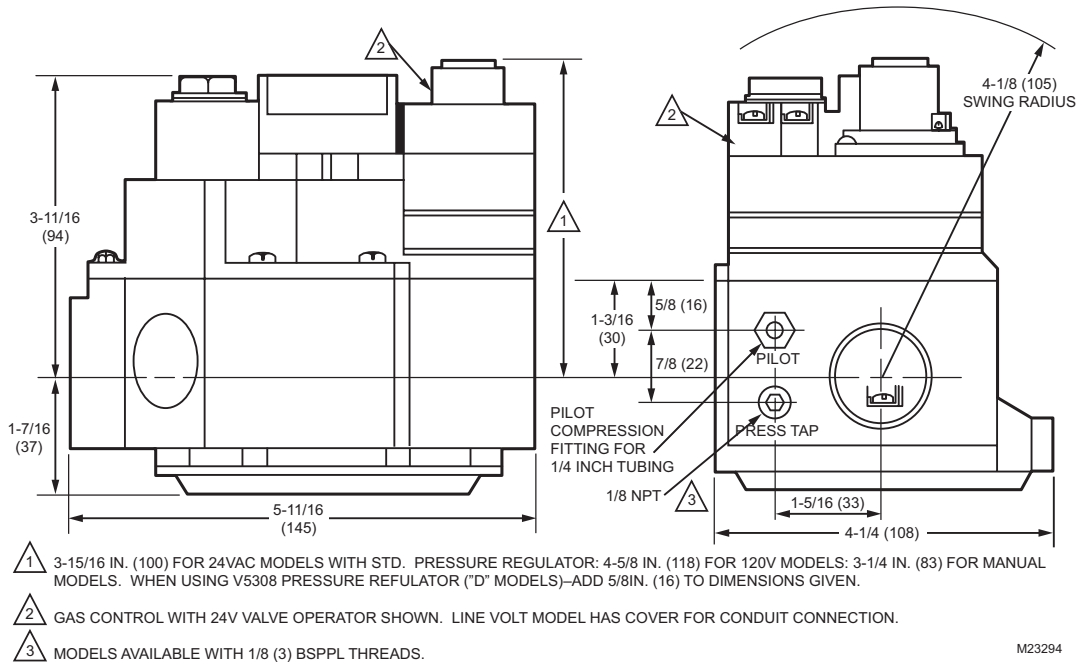

Fig. 2. V800 Family High Capacity Combination Gas Controls Installation Dimensions in inches (mm).

Approvals:

American Gas Association Design Certificate: P-G-774A.
 Underwriters Laboratories Inc. component recognized: File No. MH5323, Guide No. MCCZ2.
 DIN Approval: No. 76.01c.050 only on the V400C5011 high capacity 1 in. BSPP by 1 in. BSPP gas control.

Thermocouple required (ordered separately) for 24V, 100V, 120V, and 220/240V models: Q309 or Q340 suggested.
 Normal output: 30 mV, 0.02 ohms.
 Open circuit turndown voltage: 2 mV.
 Powerpile Generator required (order separately) for 750 mV models: Q302 or Q313 suggested.
 Nominal output: 750 mV, 3.4 ohms.
 Open circuit turndown voltage: 141 mV.

Optional Specifications:

Inlet pressure tap, 1/8 in. NPT.
Side outlets.

Replacement Parts:

392451-1 Energy Cutoff (ECO) connector.
Valve Operators
Powerpile Operator: VS824.
Modusnap Operator with modulating control: V5306.
Servo Gas Pressure Regulators.
Standard Pressure Regulator: V5306.
Step-opening pressure regulator: V5307.

INSTALLATION

When installing this product:

1. Read these instructions carefully. Failure to follow instructions can damage product or cause a hazardous condition.
2. Check ratings given in instructions and on product to make sure product is suitable for your application.
3. Make sure installer is a trained, experienced service technician.
4. After completing installation, use these instructions to check out product operation.

! WARNING

Fire or Explosion Hazard
Can cause property damage, severe injury or death. Follow this warning exactly.

1. To avoid dangerous accumulation of fuel gas, turn off gas supply at appliance service valve before starting installation and perform Gas Leak Test after completion of installation.
2. Do not bend pilot tubing at the control or pilot after compression nut has been tightened. Gas leakage at the connection may result.
3. Always install sediment trap in gas supply line to prevent contamination of gas control.
4. Do not force gas control knob. Use only your hand to turn gas control knob. Never use any tools. If gas control knob will not operate by hand, the control should be replaced by a qualified service technician. Force or attempted repair may result in fire or explosion.

! CAUTION

Disconnect power supply before wiring to prevent electrical shock or equipment damage.

Never apply a jumper across (or short) valve coil terminals. This may burn out heat anticipator in thermostat.

IMPORTANT

These gas controls are shipped with protective seals over inlet and outlet tappings. Do not remove seals until ready to connect piping.

Optional Piping Patterns—Tradeline Models

To facilitate installation, TRADELINE models incorporate side outlets in the standard straight-through body. See Fig. 3. To fit existing piping, reducer fittings also are included. These controls are shipped with side outlets plugged as shown. If connection is made to optional side outlet, be sure to install plug in standard straight-through outlet tapping. Use plug removed from side outlet. Perform Gas Leak Test when installation is complete.

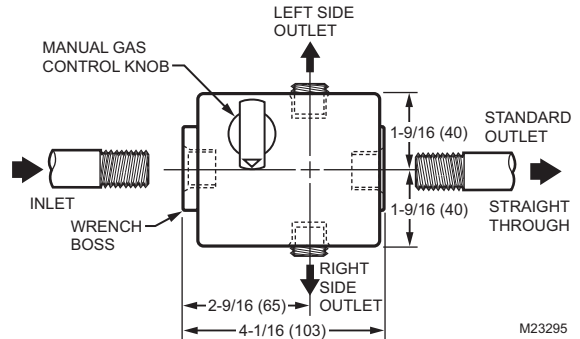

Fig. 3. Tradeline Optional Side Outlets (Standard Capacity Models only).

Follow appliance manufacturer's instructions if available; otherwise, use instructions provided below as a guide.

Location

Do not locate the combination gas control where adverse environments such as steam cleaning, high humidity or dripping water, corrosive chemicals, dust or grease accumulation, or excessive heat are prevalent. To ensure proper operation, follow these guidelines:

- Locate in a well ventilated area.
- Mount high enough above the cabinet bottom to avoid exposure to flooding or splashing water.
- Ensure that the ambient temperature does not exceed the ambient temperature ratings for each component.
- Cover if appliance is cleaned with water, steam, or chemicals or to avoid dust and grease accumulation.
- Avoid locating where exposure to corrosive chemical fumes or dripping water is likely.

Mount the combination gas control in the appliance vestibule on the gas manifold. If this is a replacement application, mount the control in same location as old control.

Install Piping to Control

All piping must comply with local codes and ordinances or with National Fuel Gas Code (ANSI Z223.1 NFPA No. 54), whichever applies. Tubing installation must comply with approved standards and practices.

1. Use new, properly reamed pipe free from chips. If tubing is used, make sure ends are square, deburred, and clean. All tubing bends must be smooth and without deformation.
2. Run pipe or tubing to the control. If tubing is used, obtain a tube-to-pipe coupling to connect tubing to the control.
3. Install sediment trap in gas supply line (Refer to Fig. 4).

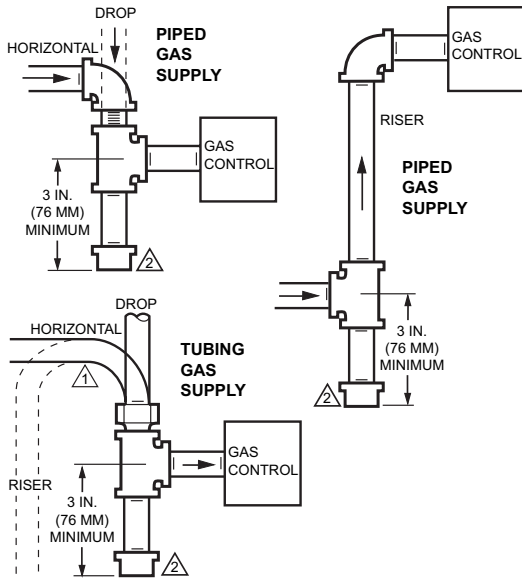

⚠ ALL BENDS IN METALLIC TUBING SHOULD BE SMOOTH.
 ⚠ CAUTION: SHUT OFF THE MAIN GAS SUPPLY BEFORE REMOVING END CAP TO PREVENT GAS FROM FILLING THE WORK AREA. TEST FOR GAS LEAKAGE WHEN INSTALLATION IS COMPLETE. M3077A

Fig. 4. Sediment Trap Installation.

Install Control

1. This control can be mounted 0-90 degrees, in any direction, from the upright position of the gas control knob, including vertically.
2. Mount the control so gas flow is in direction of arrow on bottom of control.
3. Thread pipe the amount shown in Table 6 for insertion into control. DO NOT THREAD PIPE TOO FAR. Valve distortion or malfunction may result if pipe is inserted too deeply.

Table 3. NPT Pipe Thread Length in inches.

Pipe Size (in.)	Thread Pipe this Amount (in.)	Maximum Depth Pipe can be Inserted Into Control (in.)
3/8	9/16	3/8
1/2	3/4	1/2
3/4	13/16	3/4

4. Apply a moderate amount of good quality pipe compound (DO NOT use Teflon tape) to pipe only, leaving two end threads bare. On LP installations, use compound resistant to LP gas (See Fig. 5).

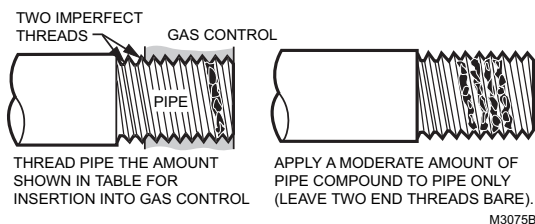

Fig. 5. Use Moderate Amount of Pipe Compound.

5. Remove seals over control inlet and outlet, if necessary.
6. Connect pipe to control inlet and outlet. To tighten inlet and outlet connections, use wrench on projecting wrench boss (See Figures 6 and 7).

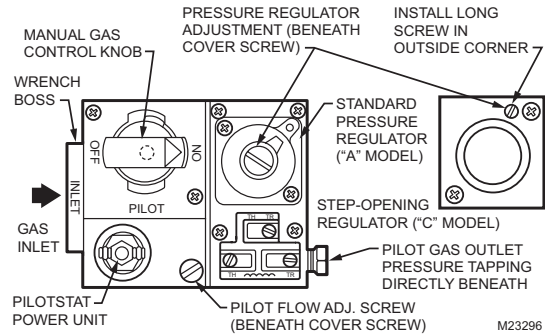

Fig. 6. Top View of Standard Capacity Gas Control.

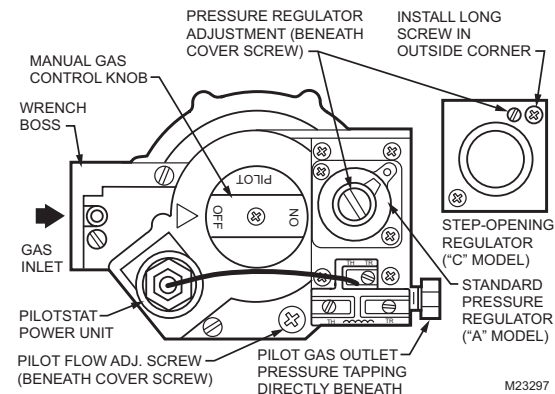

Fig. 7. Top View of High Capacity Model.

Connect Pilot Gas Tubing

1. Cut tubing to desired length and bend as necessary for routing to pilot burner. Do not make sharp bends or deform tubing. Do not bend tubing at control after compression nut has been tightened, as this may result in gas leakage at connection.
2. Square off and remove burrs from end of tubing.
3. Unscrew brass compression fitting from pilot gas outlet (Figures 6 and 7). Slip fitting over tubing and slide out of way.

NOTE: When replacing a control, cut off old compression fitting and replace with new compression fitting provided on new combination gas control. Never use old compression fitting as it may not provide a gas-tight seal. Refer to Fig. 8.

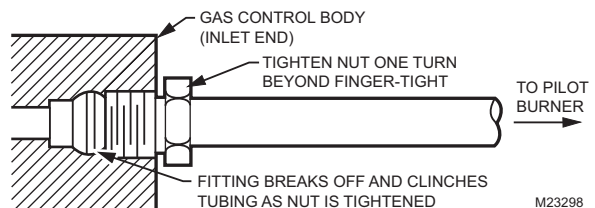

Fig. 8. Always use New Compression Fitting.

4. Push tubing into pilot gas tapping on outlet end of the control until it bottoms. While holding tubing all the way in, slide fitting into place and engage threads. Turn until finger tight. Then tighten one more turn with wrench. Do not overtighten.
5. Connect other end of tubing to pilot burner according to pilot burner manufacturer's instructions.

Connect ECO (Standard capacity 24V, 100V, 120V, and 220/240V models)

If the ECO is provided, the leadwires must be equipped with insulated 1/4 in. female quick-connect terminals. Leadwire lengths must not exceed the lengths shown in Tables 5 and 6. Connect the high-limit or ECO leadwires to the two terminals on the ECO.

Connect Thermocouple (24V, 100V, 120V, and 220/240V models)

The thermocouple connection to the power unit or electrical cut-off (ECO) connector (Figures 6 and 7) is an electrical connection and must be clean and dry. Never use pipe compound. Tighten only 1/4 turn beyond finger tight to give good electrical continuity.

If ECO is not provided, connect a Q313B thermopile generator in place of the thermocouple to act as the high-limit for the system.

Table 4. Maximum Length of Supplementary Limit Leadwires When Using Q340A Thermocouple.

Thermocouple Length		Maximum Leadwire Length x 2 (Wires)					
		AWG No. 14		AWG No. 16		AWG No. 18	
Inches	Meters	Inches	Meters	Inches	Meters	Inches	Meters
18	0.5	35	0.9	22	0.6	13	0.3
24	0.6	29	0.7	18	0.5	11	0.3
30	0.8	23	0.6	15	0.4	9	0.2
36	0.9	17	0.4	11	0.3	6	0.2
48	1.2	DO NOT USE					
72	1.8						

Table 5. Maximum Length of Supplementary Limit Leadwires When Using Q309A Thermocouple.

Thermocouple Length		Maximum Leadwire Length x 2 (Wires)					
		AWG No. 14		AWG No. 16		AWG No. 18	
Inches	Meters	Inches	Meters	Inches	Meters	Inches	Meters
12	0.3	47	1.2	30	0.8	18	0.5
18	0.5	41	1.0	26	0.7	16	0.4
24	0.6	35	0.9	22	0.6	14	0.4
30	0.8	29	0.8	18	0.5	11	0.3
36	0.9	23	0.6	15	0.4	9	0.2
40	1.0	19	0.5	12	0.3	7	0.2
48	1.2	11	0.3	7	0.2		
60	1.5	DO NOT USE					

WIRING

Follow wiring instructions furnished by appliance manufacturer, if available, or use general instructions provided below. Where instructions differ, follow appliance manufacturer's instructions.

All wiring must comply with applicable electrical codes and ordinances or with the National Electrical Code (ANSI/NFPA 70), whichever applies.

Disconnect power supply before making wiring connections to prevent electrical shock or equipment damage.

Wiring 24V Models

NOTE: The V800 and V801 have a blue terminal block. Terminals and markings are identical.

1. Make sure the power supply rating on each control matches the available supply. Install transformer, low voltage thermostat, and other controls as required.
2. Connect control circuit to operator terminals. Refer to Fig. 9 for typical 24V wiring diagram.
3. Adjust thermostat heat anticipator to 0.2 A rating stamped on valve operator.

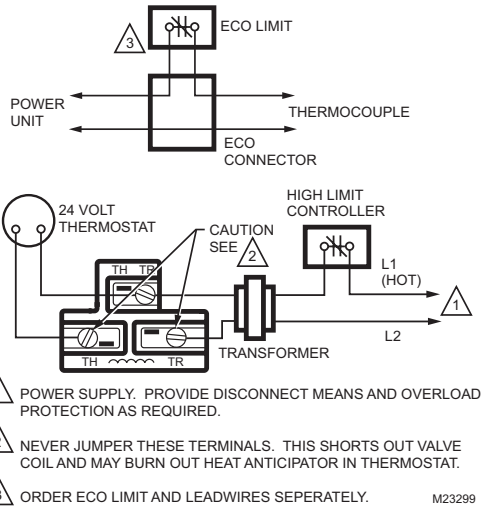

Fig. 9. Typical Wiring Hookup for 24V Systems.

Wiring 110V, 120V, 220/240V Models

1. Make sure power supply rating on each control matches available supply. Install line voltage thermostat (or controller) and other controls as required. See Fig. 10 for typical wiring diagram.
2. Use junction box, as shown, when connecting control circuit to gas control operator. Make conduit connection to operator as follows:
 - a. Slip conduit fittings over integral leadwires and screw securely into hole in operator cover.
 - b. Cut flexible conduit to appropriate length. Slip conduit over leadwires and attach to fittings.
 - c. Route and connect both flexible conduits to junction box. Connect integral wires to control circuit. Do not splice except within a junction box.

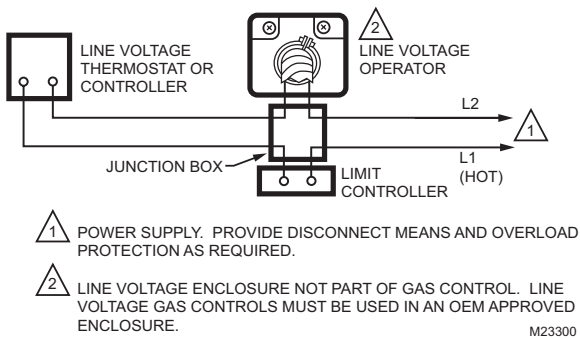

Fig. 10. Typical Wiring Hookup for 120V System.

Wiring Powerpile Models

IMPORTANT

1. Since the entire control system is powered by the millivoltage generated by the Powerpile generator, clean and scrape all wires before connecting. Solder and tape all necessary splices using rosin flux to prevent corrosion.
2. Control circuit cable length must not exceed 30 ft. (9 mm) of 2-wire, 18 gauge cable, or 50 ft. (15 m) of 2-wire, 16 gauge cable.

Follow appliance manufacturer's wiring instructions, if available, or use general instructions provided below. Where instructions differ, follow appliance manufacturer instructions.

Never connect these millivoltage controls to line voltage or to a transformer.

To prevent electrical shock or equipment damage, disconnect power supply before making wiring connections.

1. After Powerpile generator is installed in pilot burner, route generator lead to gas control.
2. Connect lead to gas control terminals labeled PP.
3. Connect thermostat leads as shown in Figures 11 or 12.

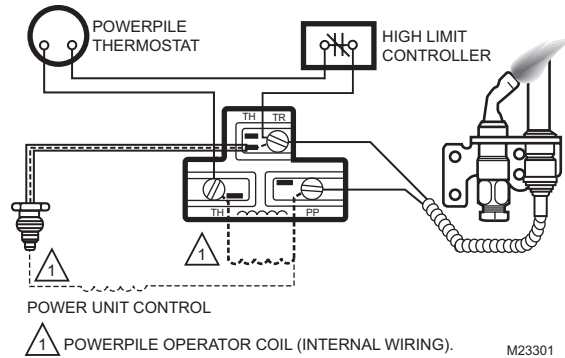

Fig. 11. Typical Wiring Connections for Gas Control with Three-Terminal Operator.

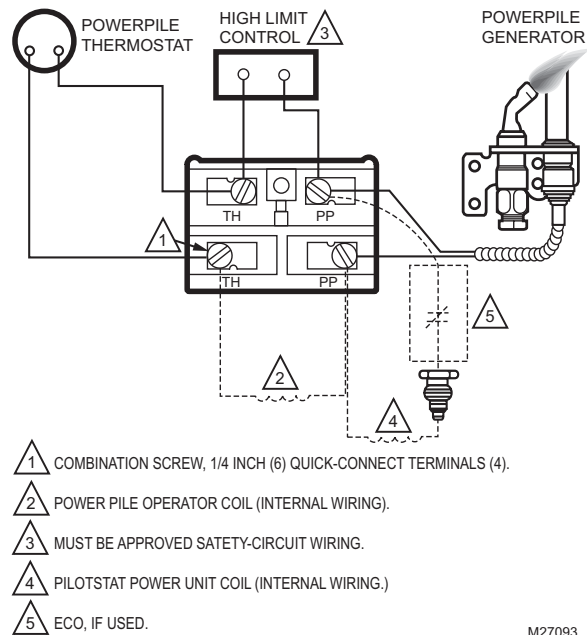

Fig. 12. Typical Wiring Connections for Gas Control with Four-Terminal Operator

STARTUP AND CHECKOUT

! WARNING

Fire or Explosion Hazard
Can cause property damage, severe injury or death.

1. Do not force the gas control knob. Use only your hand to push down the reset button or turn the gas control knob. Never use any tools.
2. If the gas control knob or reset button will not operate by hand, or if the reset button stays depressed after it is released, have a qualified service technician replace the gas control.

Gas Control Knob Settings

The gas control knob has three settings:

- OFF: Prevents pilot and main burner gas flow.
- PILOT: Permits pilot gas flow only. Gas control knob must be held depressed or thermocouple/thermopile must be heated sufficiently to hold the Pilotstat safety control valve open.
- ON: Permits pilot or main burner gas flow into gas control body. Under control of thermostat and ignition module, gas can flow to pilot and main burners.

Perform Gas Leak Test

! WARNING





Fire or Explosion Hazard.
Can cause property damage, severe injury or death.

Check for gas leaks with rich soap and water solution any time work is done on a gas control.

Gas Leak Test



1. Paint all pipe connections upstream from the gas control with a rich soap and water solution. Bubbles indicate a gas leak.
2. If a gas leak is detected, tighten the pipe connection.
3. Stand clear while lighting main burner to prevent injury caused from hidden gas leaks that could cause flashback in the appliance vestibule. Light the main burner.
4. With the main burner in operation, paint all pipe joints (including adapters) and gas control inlet and outlet with rich soap and water solution.
5. If another gas leak is detected, tighten adapter screws, joints, and pipe connections.
6. Replace the part if gas leak cannot be stopped.

Light Pilot

1. Turn gas control knob clockwise  to OFF. Wait five minutes to dissipate any unburned gas. Sniff around the appliance near the floor. Don't relight pilot if you smell gas.
2. Turn gas control knob counterclockwise  to PILOT. Push down and hold the knob while you light pilot burner.
3. Hold the gas control knob down about one minute, then release. If the pilot goes out, turn gas control knob clockwise  to OFF. Repeat steps 1-3.
4. Release gas control knob. If pilot remains lit, turn counterclockwise  to ON.

Adjust Pilot Flame

The pilot flame should envelop 3/8 to 1/2 in. (10 to 13 mm) of the tip of the thermocouple or generator. See Fig 13. To adjust:

1. Remove pilot adjustment cover screw. Refer to Figures 6 or 7.
2. Turn inner adjustment screw clockwise  to decrease or counterclockwise  to increase pilot flame.
3. Always replace cover screw after adjustment and tighten firmly to ensure proper operation.

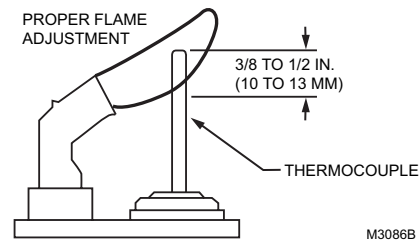

Fig. 13. Proper Flame Adjustment.

Turn on Main Burner

Follow instructions provided by appliance manufacturer or turn up thermostat to call for heat.

Check and Adjust Gas Input to Main Burner

! CAUTION



Do not exceed input rating stamped on appliance nameplate, or manufacturer's recommended burner orifice pressure for size orifice(s) used. Make certain primary air supply to main burner is properly adjusted for complete combustion. Follow appliance manufacturer's instructions.

If checking gas input by clocking gas meter: Make certain there is no gas flow through the meter other than to the appliance being checked. Other appliances must remain off with their pilots extinguished (or their consumption must be deducted from the meter reading). Convert flow rate to Btuh as described in Literature No. 70-2602. Gas Controls Handbook, and compare to the Btuh input rating on appliance nameplate.

If checking gas input with manometer: Make certain gas control is in PILOT position before removing outlet pressure tap plug to connect manometer (pressure gauge). Also turn gas control knob back to PILOT when removing gauge and replacing plug. Before removing inlet pressure tap plug, shut off gas supply at the manual valve in the gas piping to the appliance or, for LP, at the tank. Also shut off gas supply before disconnecting manometer and replacing plug. Repeat Gas Leak Test at plug with main burner operating.

(Refer to Tables 6 or 7), replace gas control. Otherwise, take the necessary steps to provide proper gas pressure on the control.

Standard Pressure Regulator

1. Check the manifold pressure listed on the appliance nameplate. Gas control outlet pressure should match the nameplate.
2. With main burner operating, check gas control flow rate using the meter clocking method or pressure using a manometer connected to the outlet pressure tap on the gas control (Refer to Figures 6 or 7 depending on model).
3. If necessary, adjust the pressure regulator to match the appliance rating. Refer to Tables 6 or 7 for factory set nominal outlet pressure and adjustment range.
 - a. Remove pressure regulator adjustment cap screw.
 - b. Using screw driver, turn inner adjustment screw clockwise  to increase or counterclockwise  to decrease gas pressure to burner.
 - c. Always replace cap screw and tighten firmly to prevent gas leakage.
4. If desired outlet pressure or flow rate cannot be achieved by adjusting the gas control, check gas control inlet pressure using a manometer at the gas control inlet pressure tap. If inlet pressure is in the nominal range

Step-Opening Pressure Regulator



1. The gas control outlet pressure should match the full rate manifold pressure listed on the appliance nameplate.
2. With main burner operating, check gas control flow rate using the meter clocking method or check gas pressure using a manometer connected to the gas control outlet pressure tap (See Figures 6 or 7).
3. If necessary, adjust pressure regulator to match appliance rating. Refer to Tables 6 or 7 for factory set nominal outlet pressures and adjustment ranges.
 - a. Remove pressure regulator adjustment cap and screw.
 - b. Using screw driver, turn inner adjustment screw clockwise  to increase or counterclockwise  to decrease gas pressure to main burner.
 - c. Always replace cap screw and tighten firmly to ensure proper operation.
4. If desired outlet pressure or gas flow rate cannot be achieved by adjusting the gas control, check gas control inlet pressure using a manometer at the gas control inlet pressure tap. If inlet pressure is in the normal range (See Tables 6 or 7), replace existing gas control. Otherwise, take the necessary steps to provide proper gas pressure to the control.
5. Carefully check burner lightoff at step pressure. Make sure burner lights smoothly and without flashback to orifice. Make sure all ports remain lit. Cycle burner several times, allowing at least 30 seconds between cycles for regulator to resume step function. Repeat after allowing burner to cool. Readjust full rate outlet pressure if necessary to improve lightoff characteristics.

Table 6. Pressure Regulator Specification Pressures (in. wc).

Model	Type of Gas	Nominal Inlet pressure Range	Outlet Pressure			
			Nominal Factory Setting		Setting Range	
			Step	Full Rate	Step	Full Rate
VS820A,H,V; VS821A	Natural	5.0 - 7.0	--	3.5	--	3.0-5.0
	LP	12.0 - 14.0	--	11.0	--	8.0- 2.0
VS820C, VS821C	Natural	5.0 - 7.0	0.9 ^a	3.5	None	3.0-5.0
	LP	12.0 - 14.0	2.2 ^b	11.0	None	8.0-12.0

^a Unregulated step pressure at 7.0 in. wc inlet pressure.

^b Unregulated step pressure at 14.0 in. wc inlet pressure.

Table 7. Pressure Regulator Specification Pressures (kPa).

Model	Type of Gas	Nominal Inlet pressure Range	Outlet Pressure			
			Nominal Factory Setting		Setting Range	
			Step	Full Rate	Step	Full Rate
VS820A, H,V; VS821A	Natural	1.2 - 1.7	--	0.9	--	0.7 - 1.2
	LP	2.9 - 3.9	--	2.7	--	2.0 - 3.0
VS820C, VS821C	Natural	1.2 - 1.7	0.2 ^a	0.9	None	0.7 - 1.2
	LP	2.9 - 3.9	0.5 ^b	2.7	None	2.0 - 2.0

^a Unregulated step pressure at 1.7 kPa inlet pressure.

^b Unregulated step pressure at 3.9 kPa inlet pressure.

Check Safety Shutdown Performance

WARNING

Fire or Explosion Hazard.
Can cause property damage, severe injury or death.

Perform the safety shutdown test every time work is done on a gas system.

1. Place gas control knob in PILOT position. Main burner should go off and pilot should remain lit.
2. Extinguish pilot flame. Pilot gas flow should stop within 2-1/2 minutes. Safety shutoff of pilot gas proves complete shutdown because safety shutoff valve prohibits main burner and pilot gas flow.
3. Relight pilot burner and operate system through one complete cycle to ensure all controls operate properly.

MAINTENANCE

WARNING

Fire or Explosion Hazard.
Can cause property damage, severe injury, or death.

Improper cleaning or reassembly may cause gas leakage. When cleaning, ensure that control is reassembled properly and perform gas leak test.

Regular preventive maintenance is important in applications that place a heavy load on system controls, such as in the commercial cooking and agricultural and industrial industries because:

- In many such applications, particularly commercial cooking, the equipment operates 100,000-200,000 cycles per year. Such heavy cycling can wear out the gas control in one to two years.
- Exposure to water, dirt, chemicals and heat can damage the gas control and shut down the control system.

The maintenance program should include regular checkout of the gas control as outlined under STARTUP AND CHECKOUT and the control system as described in the appliance manufacturer's literature.

Maintenance frequency must be determined individually for each application. Some considerations are:

- *Cycling frequency.* Appliances that may cycle 100,000 times annually should be checked monthly.
- *Intermittent use.* Appliances that are used seasonally should be checked before shutdown and again before the next use.
- *Consequence of unexpected shutdown.* Where the cost of an unexpected shutdown would be high, the system should be checked more often.
- *Dusty, wet or corrosive environment.* Since these environments can cause the gas control to deteriorate more rapidly, the system should be checked more often.

The gas control should be replaced if:

- It does not perform properly on checkout or troubleshooting.
- The gas control knob is hard to turn or push down, or it fails to pop back up when released.
- The control is likely to have operated for more than 200,000 cycles.

OPERATION

The V800 combination gas control family provides 3-position (OFF-PILOT-ON) manual control of gas flow. In Fig. 14, the gas control knob is in the ON position, the pilot is proven by the thermocouple/generator, and the thermostat is calling for heat.

Gas Control Knob at Off

The manual safety shutoff valve and main valve are closed. No gas flows into the control.

Gas Control Knob at Pilot

The manual safety shutoff valve and main valve are closed until the gas control knob is manually depressed. When depressed, the manual safety shutoff valve is opened, allowing pilot gas flow so the pilot can be lit. After about one minute, the thermocouple/generator current is enough, so that power unit holds the manual shutoff valve open. The main valve remains closed and prevents main burner gas flow until the thermostat calls for heat.

Gas Control Knob at On; No Call for Heat

This is the standby position. The safety shutoff valve is open, but the main valve is closed. Gas flow is restricted to the pilot only.

Gas Control Knob at On; Thermostat Calls for Heat

On a call for heat, the valve operator opens the left-hand port and closes the right-hand port. Gas flows through the working gas channel, increasing the working gas pressure. The increased pressure pushes against the main valve diaphragm, opening the main valve and permitting gas flow through the control to the main burner. The servo pressure regulator controls outlet gas pressure to the main burner.

Gas Control Knob at Off; Thermostat Ends Call for Heat

When a call for heat ends, the valve operator closes the left-hand port and opens the right-hand port. Gas flow through the working gas channel is reversed, decreasing the working gas pressure. The decreased pressure allows the main valve diaphragm to retract and close the main valve. The working gas flows through the evacuation channel to the gas outlet to the main burner. The safety valve remains open, allowing pilot gas flow.

Loss of Pilot Flame

The Pilotstat safety shutoff mechanism shuts down the combination gas control if the pilot flame becomes extinguished or too small for satisfactory burner ignition.

As the pilot burns, it constantly heats the thermocouple or Powerpile generator, providing current for the Pilotstat power unit in the gas control. A properly burning pilot supplies the power unit with enough current to keep the safety valve open and allow pilot gas flow. If the pilot goes out or decreases current to the power unit, the power unit will "drop out", closing the safety valve and preventing pilot gas flow and main burner gas flow. To restart the system, the pilot flame must be manually relit and the Pilotstat must be manually reset.

The VS820 and VS821 Powerpile models generate current independent of the line voltage and continue regulating pilot and main burner gas flow. Therefore, in a power outage, the gas control continues operating.

Servo Pressure Regulators

When the pilot flame is burning properly and the thermostat calls for heat, the servo pressure regulator senses and varies the outlet pressure to the main burner. When the thermostat

calls for heat, the valve operator ON-OFF lever opens the left-hand gas supply port, lifting the servo regulator valve off its seat and allowing gas flow into the working gas channel and evacuation channel. The working gas channel gas flow increases the pressure in the working gas pressure chamber which raises the main valve diaphragm and lifts the main valve off its seat, allowing main burner gas flow.

Outlet gas pressure variations are instantly reflected through the evacuation channel to reposition the servo regulator diaphragm. Repositioning the diaphragm adjusts the outlet pressure by altering the flow rate through the servo regulator valve.

When the outlet pressure rises, the servo regulator valve opens and allows more evacuation channel gas flow. This decreases the pressure in the working gas pressure chamber and lowers the main valve toward its seat, lowering the outlet pressure.

The opposite occurs when the outlet pressure falls. The servo regulator valve closes and allows less evacuation channel gas flow. This increases the pressure in the working gas pressure chamber and raises the main valve from its seat, raising outlet pressure.

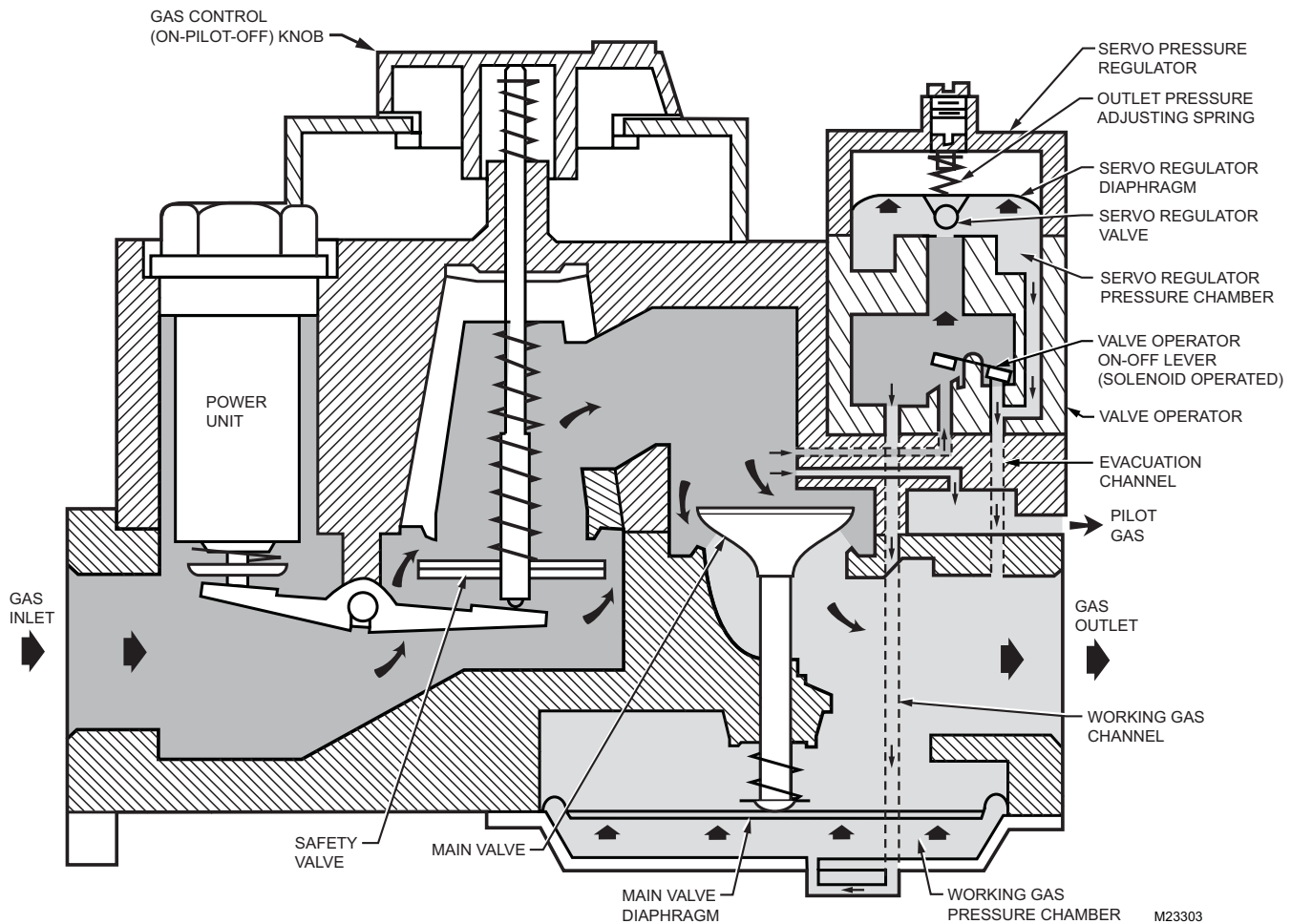

Fig. 14. Gas Flow through the V800 Combination Gas Control Family.

SERVICE

WARNING

Fire or explosion hazard.

Can cause property damage, severe injury or death.

Do not disassemble the gas control; it contains no replaceable components. Attempted disassembly or repair will damage the gas control.

CAUTION

Equipment Damage Hazard.

Can cause property damage.

Do not apply a jumper across or short the valve coil terminals. This may burn out the heat anticipator in the thermostat.

IMPORTANT

Allow 60 seconds after shutdown before re-energizing the step-opening model to ensure lightoff at step pressure.

If the Pilot will not light

1. Ensure the main gas supply valve is open and the pilot gas supply line is purged of air.
2. Attempt to light pilot burner flame following procedures in Light Pilot section. If pilot still will not light:
 - a. Check the pilot gas adjustment screw. If closed, readjust the pilot flame. Refer to Adjust the Pilot Burner Flame section.
 - b. Perform the Gas Leak Test at the compression fitting. If a gas leak is detected, replace the old compression fitting or tighten the newly installed one (Refer to Fig. 8).
 - c. Ensure that the pilot burner tubing or pilot burner orifice is not clogged. If clogged, replace combination gas control.

If the Pilot goes out when the gas control knob is released

1. Ensure the gas control knob is held in at least one minute to allow the thermocouple or generator time to heat.
2. Adjust thermostat several degrees above room temperature.
3. For VS820 and VS821, disconnect leadwires to lower left TH terminal and lower right PP terminal to isolate valve operator coil from balance of circuit. Measure resistance of coil. If coil is not 2 ohms \pm 10 percent, replace VS824A Valve Operator.
4. In Powerpile applications, ensure jumper between valve operator and power unit is secure and connections are clean.
5. In thermocouple applications, ensure connection to power unit is tightened 1/4 turn beyond finger tight.
6. If pilot still goes out, measure the open and closed thermocouple or generator circuit output voltages. Compare it to the acceptable range charts in the thermocouple or generator specifications or in the Gas Controls Handbook. Replace the thermocouple or generator circuit if voltages are outside the acceptable range.

7. Check the power unit resistance. If above 11 ohms, replace the gas control.

If the Main Burner will not come on with a call for heat

1. Ensure the gas control knob is in the ON position.
2. Adjust the thermostat several degrees above room temperature.
3. For VS820 and VS821, disconnect leadwires to lower left the TH terminal and lower right PP terminal to isolate valve operator coil from balance of circuit. Measure resistance of coil. If coil is not 2 ohms \pm 10 percent, replace VS824A Valve Operator.
4. For all other models, use an ac voltmeter to measure the voltage across terminals TH and TR.
 - a. If no voltage is present, check the control circuit for proper operation.
 - b. If proper control system voltage is present, but first operator did not "click" open, check for excessive inlet gas pressure. If inlet gas pressure is correct, replace the gas control.
 - c. If proper control system voltage is present and first valve operator "clicked" open, replace second operator assembly.
5. Measure the open and closed thermocouple or generator output voltages and compare to the acceptable range charts in the thermocouple or generator specifications or in the Gas Controls Handbook. Replace the thermocouple or generator if voltages are outside the acceptable range.

If Burner is overfiring

Adjust the gas control pressure regulator to the correct pressure. If the regulator cannot be adjusted and supply pressure is in the normal range, replace the gas control.

INSTRUCTIONS TO THE APPLIANCE OWNER

For Your Safety, Read Before Lighting

WARNING

Fire or Explosion Hazard.

Can cause property damage, severe injury or death.

If you do not exactly follow the warning below and the lighting instructions, a fire or explosion can result in property damage, personal injury or loss of life.

1. Before lighting, smell all around the appliance area for gas. If the appliance uses LP (bottled) gas, also be sure to smell next to the floor because LP gas is heavier than air. If you smell gas, immediately shut off the manual valve in the gas piping to the appliance, or ON LP SYSTEM, AT THE TANK. Do not try to light any appliance. Do not touch any electrical switch or use the phone. LEAVE THE BUILDING and call your gas supplier. If your gas supplier cannot be reached, call the fire department.

2. Do not force the gas control knob on the appliance. Use only your hand to push down the reset button or turn the gas control knob. Never use any tools. If the knob or reset button will not operate by hand, replace the control using a qualified service technician. Force or attempted repair can result in fire or explosion.
3. Replace the gas control if it has been flooded with water. Call a qualified service technician.
4. If the red reset button stays depressed after it is released, replace the gas control.
5. The gas control is a safety device. It must be replaced in event of any physical damage such as bent terminals, missing or broken parts, stripped threads, or evidence of exposure to heat.

IMPORTANT

Follow the operating instructions provided by the manufacturer of your heating appliance. Use the information below for a typical control application; however, the specific controls used and the procedures outlined by the manufacturer of your appliance can differ, requiring special instructions.



To Light the Main Burner

STOP: Read the safety information above.

This appliance has a pilot burner that must be lit by hand. If the pilot flame has gone out, follow these instructions exactly:

1. Set thermostat to lowest setting and shut off electric power to appliance.
2. Remove control access panel if provided on your appliance.
3. Push in gas control knob (Refer to Figures 6 or 7) clockwise  to OFF position.

NOTES: Knob cannot be turned from PILOT to OFF unless knob is pushed in slightly. Do not force.

4. Wait five (5) minutes to clear out any gas. If you smell gas, STOP! Follow Item 1 in the Warnings on the previous page. If you don't smell gas, go to next step.
5. Remove the pilot access panel located below and behind the gas control unit.
6. Find the pilot - follow metal tube from gas control. The pilot is between the two burner tubes behind the pilot access panel.
7. Turn knob on gas control counterclockwise  to PILOT.
8. Push in control knob all the way and hold in. Immediately light the pilot with a match. Continue to hold the control knob in for about one (1) minute after the pilot is lit. Release knob and it will pop back up. Pilot should remain lit. If it goes out repeat steps 5-8.
9. Replace pilot access panel.
10. Turn gas control knob counterclockwise  to ON.
11. Replace burner access panel.
12. Turn on electrical power to the appliance.
13. Set thermostat to desired temperature.

To Turn Off Appliance

VACATION SHUTDOWN

Turn gas control knob clockwise  from ON to PILOT. Pilot remains lit, ready for return to normal service without relighting.

COMPLETE SHUTDOWN

Push in gas control knob slightly and turn clockwise  to OFF. Do not force. Both pilot and main burner are shut off. The pilot must be manually relit when normal burner operation is desired. Follow the provided instructions.

Automation and Control Solutions

Honeywell International Inc.
1985 Douglas Drive North
Golden Valley, MN 55422
customer.honeywell.com

Honeywell Limited-Honeywell Limitée
35 Dynamic Drive
Toronto, Ontario M1V 4Z9

® U.S. Registered Trademark
© 2008 Honeywell International Inc.
60-2019—8 J.I. Rev. 02-08



Printed in U.S.A. on recycled
paper containing at least 10%
post-consumer paper fibers.

Honeywell