

## Section 6

## Transformers

<b>Miscellaneous</b>	<b>6-1</b>
Class 7400	6-2
<b>General Purpose Dry Type 600 Volts and Below</b>	<b>6-3</b>
K-Rated Transformers	6-3
Drive Isolation Transformers	6-5
Open Core and Coil Transformers	6-6
<b>Industrial Control</b>	<b>6-7</b>
Type EO Transformers	6-7
Type T and MultiTap™ Transformers	6-7
<b>Instrument 600 Volt Class</b>	<b>6-8</b>
Voltage and Current Transformers	6-9
Toroidal Current Transformers	6-10
Toroidal Current Transformers (64R, 74R, 66R, 76R)	6-10
Toroidal Current Transformers (110R, 110R, 120R, 140R)	6-10
Toroidal Current Transformers (152R, 170R, 180R, 210R)	6-11
Toroidal Current Transformers (200R, 201R, 202R, 203R)	6-12
Shorting Terminal Blocks	6-12
Current Transformers: Multi-Ratio, Rectangular, Split-Core	6-12
Multi-Ratio Current Transformers	6-12
Rectangular Window Current Transformers	6-13
Split-Core Current Transformers	6-13
Current Transformers: Bushing, Auxiliary	6-14
Bushing Current Transformers 50–400 Hz	6-14
Auxiliary Current Transformers	6-14
Transformers—Obsolete	6-15
Obsolete—January 1, 2016 Energy Efficient Three-Phase	6-15
Obsolete—January 1, 2016 EE Watchdog Transformers	6-16
Obsolete—January 1, 2016 EE NL and NLP Series Transformers	6-17

Enclosure Dimensions and Accessories [1]

Enclosure Number/ Style		Height		Width		Depth		Mounting	Weather-shield	Wall Mounting Bracket	Ceiling Mounting Bracket	Insulation Class °C	
		In.	mm	In.	mm	In.	mm						
1	A	5.00	127	4.47	114	3.44	87	Wall	[2]	[3]	—	105	
2	A	5.50	140	4.47	114	3.44	87	Wall			—	105	
3	A	5.00	127	4.85	123	3.75	95	Wall			—	105	
4	A	5.50	140	5.23	133	4.06	103	Wall			—	130	
5	A	6.19	157	6.19	157	4.69	119	Wall			—	130	
6	A	6.69	170	6.19	157	4.69	119	Wall			—	180	
7	A	8.13	270	6.94	176	5.31	135	Wall			—	180	
8	A	8.25	210	8.68	220	6.56	167	Wall			—	180	
9	A	9.56	243	8.68	220	6.56	167	Wall			—	180	
10	A	10.50	267	8.62	219	6.50	165	Wall			—	180	
11	A	12.56	319	8.62	219	6.50	165	Wall			—	180	
12	C	13.50	343	14.75	375	9.00	229	Wall			—	180	
13	B	14.75	375	9.75	248	11.75	298	Wall			—	180	
14	C	14.75	375	19.10	485	12.25	311	Wall			—	180	
15	B	20.00	508	15.00	381	13.50	343	Wall			—	180	
16	C	22.00	559	25.00	635	13.50	343	Wall			—	180	
17	D	27.00	686	20.00	508	16.00	406	Floor	WS363	WMB361362	CMB363	220	
	E	27.00	686	20.00	508	16.00	406	Floor	[4]	WMB361362	CMB363	220	
	H	37.00	940	20.00	508	16.00	406	Floor	WS363	WMB361362	CMB363	220	
18	D	30.00	762	20.00	508	20.00	508	Floor	WS363	WMB363364	CMB363	220	
	E	30.00	762	20.00	508	20.00	508	Floor	[4]	WMB363364	CMB363	220	
	H	37.00	940	20.00	508	20.00	508	Floor	WS363	WMB363364	CMB363	220	
19	D	30.00	762	30.00	762	20.00	508	Floor	WS364	WMB363364	CMB364	220	
	E	30.00	762	30.00	762	20.00	508	Floor	[4]	WMB363364	CMB364	220	
20	D	37.00	940	30.00	762	20.00	508	Floor	WS364	WMB363364	CMB364	220	
	E	37.00	940	30.00	762	20.00	508	Floor	[4]	WMB363364	CMB364	220	
21	D	37.00	940	30.00	762	24.00	610	Floor	WS364	—	CMB364	220	
	E	37.00	940	30.00	762	24.00	610	Floor	[4]	—	CMB364	220	
22	D	43.75	1111	32.00	813	27.00	686	Floor	WS380	—	CMB380	220	
	E	43.75	1111	32.00	813	27.00	686	Floor	[4]	—	CMB380	220	
23	E	48	1219	48	1219	29.5	749	Floor	[5]	—	—	220	
24	D	49.5	1257	35	889	28.5	724	Floor	WS381	—	CMB381	220	
	E	49.5	1257	35	889	28.5	724	Floor	Note 5	—	CMB381	220	
25	D	49.5	1257	41	1041	32	813	Floor	WS382	—	—	220	
	E	49.5	1257	41	1041	32	813	Floor	[4]	—	—	220	
26	D	57.5	1461	41	1041	32	813	Floor	WS382	—	—	220	
28	D	60	1524	56	1422	36	914	Floor	WS370A	—	—	220	
	E	60	1524	56	1422	36	914	Floor	[4]	—	—	220	
29	D	68	1727	56	1422	36	914	Floor	WS370A	—	—	220	
30	D	71	1803	48	1219	36	914	Floor	WS383	—	—	220	
	E	71	1803	48	1219	36	914	Floor	[4]	—	—	220	
31	D	74	1880	56	1422	40.5	1029	Floor	WS384	—	—	220	
	E	74	1880	56	1422	40.5	1029	Floor	[4]	—	—	220	
32	F	91.5	2388	56	1422	54	1372	Floor	[6]	—	—	220	
33	F	94	2388	72	1829	54	1372	Floor		—	—	—	220
34	F	94	2388	84	2134	54	1372	Floor		—	—	—	220
35	F	94	2388	96	2438	54	1372	Floor		—	—	—	220
36	D	40.5	1031	36.5	916	21.75	553	Floor		—	—	—	220
37	D	51.5	1310	40.5	1031	26.5	674	Floor		—	—	—	220
38	D	66	1679	50.5	1285	32	814	Floor		—	—	—	220
39	F	90	2290	80	2036	50	1272	Floor		—	—	—	220
40	F	90	2290	90	2290	50	1272	Floor		—	—	—	220
41	F	100	2545	100	2545	60	1527	Floor		—	—	—	220
42	F	108	2748	108	2748	60	1527	Floor		—	—	—	220
43	F	90	2290	64	1628	44	1120	Floor		—	—	—	220
44	F	90	2290	72	1832	50	1272	Floor	—	—	—	220	
45	D	80	2036	64	1628	44	1120	Floor	—	—	—	220	
51	X	9.5	24	10	25	7.75	20	Wall	[7]	[3]	—	180	
52	X	12	30	13.75	35	13.75	35	Wall			—	180	
53	X	24	61	21.5	55	16.38	42	Wall			—	180	
54	X	23	58	25.5	65	13.75	35	Wall			—	180	
55	X	31.5	80	31.5	80	16.25	41	Wall			—	180	
61	HX												
62	HX												
63	HX												

Contact your local Schneider Electric representative for details.

**NOTE:** Wall mounting brackets are used with units weighing no more than 700 lbs. Ceiling mounting brackets are used with units weighing no more than 1200 lbs. Weathershields are available for units 600 Volts and below. For 2.4, 5, and 15 kV units suitable for outdoor use, contact the factory.

[1] These dimensions are not for construction. Contact your local Schneider Electric representative for certified prints.  
 [2] Transformer is NEMA Type 3R Standard. Weathershield not required for outdoor use.  
 [3] Wall mounting brackets are a standard part of transformer enclosure. Accessory not required.  
 [4] Indoor/outdoor enclosure standard. Weathershield not required.  
 [5] Indoor/outdoor enclosure standard. Weathershield not required.  
 [6] Special outdoor construction required for NEMA Type 3R applications. Contact your local Schneider Electric representative for details.  
 [7] Transformer is NEMA Type 4X Standard. Weathershield not required.

**Obsolete—October 1, 2015**  
**K-Rated, Three-Phase (15–1000 kVA)**

K-rated transformers mitigate Triplen harmonics via a Delta-Wye configuration.

- Aluminum or copper windings
- Isolation transformer with electrostatic shield
- K-4 and K-13 levels

**Harmonic Mitigating, Three-Phase (15–1000 kVA)**

Harmonic Mitigating transformers mitigate Triplen harmonics via electromagnetic phase relations. They remove 5th and 7th harmonics when using dual devices with a 0° and a +30° phase shift. They further reduce 11th and 13th harmonics when a +15° or -15° shift is added to the dual devices. Available with:

- Aluminum or copper windings
- Isolation transformer

**NEMA Premium**

**Table 6.1: 480 V Delta Primary, 208Y/120 Secondary**

kVA	Catalog No.	Taps	Weight (lbs)	Enclosure
<b>NP Series for Typical Non-Linear Load Service—K-9 Rated—Copper Windings; 130 °C Rise</b>				
15	EP15T3HNISCUNP	6–2.5% 2+4–	310	17D
30	EP30T3HNISCUNP	6–2.5% 2+4–	340	18D
45	EP45T3HNISCUNP	6–2.5% 2+4–	418	20D
75	EP75T3HNISCUNP	6–2.5% 2+4–	642	21D
112.5	EP112T3HNISCUNP	6–2.5% 2+4–	725	22D
150	EP150T3HNISCUNP	6–2.5% 2+4–	915	24D
225	EP225T3HNISCUNP	6–2.5% 2+4–	1125	25D
300	EP300T3HNISCUNP	4–2.5% 2+2–	1535	30D
<b>NP Series for Typical Non-Linear Load Service—K-9 Rated—Copper Windings; 115 °C Rise</b>				
15	EP15T3HFISCUNP	6–2.5% 2+4–	310	17D
30	EP30T3HFISCUNP	6–2.5% 2+4–	340	18D
45	EP45T3HFISCUNP	6–2.5% 2+4–	418	20D
75	EP75T3HFISCUNP	6–2.5% 2+4–	642	20D
112.5	EP112T3HFISCUNP	6–2.5% 2+4–	725	22D
150	EP150T3HFISCUNP	6–2.5% 2+4–	915	24D
225	EP225T3HFISCUNP	6–2.5% 2+4–	1125	25D
300	EP300T3HFISCUNP	4–2.5% 2+2–	1535	25D
<b>NLP Series for More Severe Non-Linear Load Service—K-13 Rated—Copper Windings; 150 °C Rise</b>				
15	EP15T3HISCUNLP	6–2.5% 2+4–	260	17D
30	EP30T3HISCUNLP	6–2.5% 2+4–	430	18D
45	EP45T3HISCUNLP	6–2.5% 2+4–	730	20D
75	EP75T3HISCUNLP	6–2.5% 2+4–	640	20D
112.5	EP112T3HISCUNLP	6–2.5% 2+4–	985	22D
150	EP150T3HISCUNLP	6–2.5% 2+4–	1135	24D
225	EP225T3HISCUNLP	6–2.5% 2+4–	1477	25D
300	EP300T68HISCUNLP	4–2.5% 2+2–	2650	30D

As a partner in the NEMA Premium Transformer Program, Schneider Electric has determined that this product meets the NEMA Premium Efficiency specifications for premium energy efficiency.



Obsolete—October 1, 2015



**Table 6.2: Harmonic Mitigating, 480 Primary to 208zz/120 Secondary; Copper Windings**

kVA	Catalog No.	Taps	Weight (lbs)	Enclosure
<b>0° Phase Shift</b>				
15	HM15T208HNCUEP	6-2.5% 2+4-	310	17D
30	HM30T208HNCUEP	6-2.5% 2+4-	340	17D
45	HM45T208HNCUEP	6-2.5% 2+4-	418	18D
75	HM75T208HNCUEP	6-2.5% 2+4-	642	20D
112.5	HM112T208HNCUEP	6-2.5% 2+4-	725	21D
150	HM150T208HNCUEP	6-2.5% 2+4-	915	22D
225	HM225T208HNCUEP	6-2.5% 2+4-	1125	24D
300	HM300T208HNCUEP	6-2.5% 2+4-	1535	25D
<b>30° Phase Shift</b>				
15	HM15T255HNCUEP	3-5% 1+2-	310	17D
30	HM30T255HNCUEP	3-5% 1+2-	340	17D
45	HM45T255HNCUEP	3-5% 1+2-	418	18D
75	HM75T255HNCUEP	3-5% 1+2-	642	20D
112.5	HM112T255HNCUEP	3-5% 1+2-	725	21D
150	HM150T255HNCUEP	3-5% 1+2-	915	22D
225	HM225T255HNCUEP	3-5% 1+2-	1125	24D
300	HM300T255HNCUEP	3-5% 1+2-	1535	25D
<b>+15° Phase Shift</b>				
15	HM15T251HNCUEP	6-2.5% 2+4-	310	17D
30	HM30T251HNCUEP	6-2.5% 2+4-	340	17D
45	HM45T251HNCUEP	6-2.5% 2+4-	418	18D
75	HM75T251HNCUEP	6-2.5% 2+4-	642	20D
112.5	HM112T251HNCUEP	6-2.5% 2+4-	725	21D
150	HM150T251HNCUEP	6-2.5% 2+4-	915	22D
225	HM225T251HNCUEP	6-2.5% 2+4-	1125	24D
300	HM300T251HNCUEP	6-2.5% 2+4-	1535	25D
<b>-15° Phase Shift</b>				
15	HM15T259HNCUEP	6-2.5% 2+4-	310	17D
30	HM30T259HNCUEP	6-2.5% 2+4-	340	17D
45	HM45T259HNCUEP	6-2.5% 2+4-	418	18D
75	HM75T259HNCUEP	6-2.5% 2+4-	642	20D
112.5	HM112T259HNCUEP	6-2.5% 2+4-	725	21D
150	HM150T259HNCUEP	6-2.5% 2+4-	915	22D
225	HM225T259HNCUEP	6-2.5% 2+4-	1125	24D
300	HM300T259HNCUEP	6-2.5% 2+4-	1535	25D

Additional temperature rises are available; for part numbers, see the Schneider Electric Product Configurator.

**Drive Isolation Transformers**

Special design considerations must be made for the requirements of both adjustable frequency and dc motor drive power isolation. Allowance for high surge, harmonic and offset currents are taken into account in the design of Square D™ brand drive isolation transformers. Drive isolation transformers are not shielded isolation transformers, but act to lessen transient generation into the supply power and act as a buffer for SCR current surges.

**Table 6.3: Three-Phase 60 Hz; Class B  
(IEEE Standard 597-1983); 460 V Delta Primary**

kVA	Catalog No.	Full Capacity Taps	Weight (lbs) [1]	Enclosure [1][2]
<b>460 V Delta Primary, 460Y/265 V Secondary, 150 °C Rise</b>				
7.5	7T145HDIT	2-5%1 + 1-	180	17D
11	11T145HDIT	2-5%1 + 1-	180	17D
15	15T145HDIT	2-5%1 + 1-	190	17D
20	20T145HDIT	2-5%1 + 1-	210	17D
27	27T145HDIT	2-5%1 + 1-	250	17D
34	34T145HDIT	2-5%1 + 1-	295	18D
40	40T145HDIT	2-5%1 + 1-	350	18D
51	51T145HDIT	2-5%1 + 1-	445	20D
63	63T145HDIT	2-5%1 + 1-	465	20D
75	75T145HDIT	2-5%1 + 1-	550	20D
93	93T145HDIT	2-5%1 + 1-	845	22D
118	118T145HDIT	2-5%1 + 1-	920	22D
145	145T145HDIT	2-5%1 + 1-	1025	22D
175	175T145HDIT	2-5%1 + 1-	1120	25D
220	220T145HDIT	2-5%1 + 1-	1200	25D
275	275T145HDIT	2-5%1 + 1-	1500	25D
330	330T145HDIT	2-5%1 + 1-	1390	25D
440	440T145HDIT	2-5%1 + 1-	2700	30D
550	550T145HDIT	2-5%1 + 1-	3800	30D
<b>460 V Delta Primary, 230Y/132 V Secondary, 150 °C Rise</b>				
7.5	7T144HDIT	2-5%1 + 1-	180	17D
11	11T144HDIT	2-5%1 + 1-	180	17D
15	15T144HDIT	2-5%1 + 1-	190	17D
20	20T144HDIT	2-5%1 + 1-	210	17D
27	27T144HDIT	2-5%1 + 1-	250	17D
34	34T144HDIT	2-5%1 + 1-	295	18D
40	40T144HDIT	2-5%1 + 1-	350	18D
51	51T144HDIT	2-5%1 + 1-	445	20D
63	63T144HDIT	2-5%1 + 1-	465	20D
75	75T144HDIT	2-5%1 + 1-	550	20D
93	93T144HDIT	2-5%1 + 1-	845	22D
118	118T144HDIT	2-5%1 + 1-	920	22D
145	145T144HDIT	2-5%1 + 1-	1025	22D
175	175T144HDIT	2-5%1 + 1-	1120	25D
220	220T144HDIT	2-5%1 + 1-	1200	25D
275	275T144HDIT	2-5%1 + 1-	1500	25D
330	330T144HDIT	2-5%1 + 1-	1390	25D
440	440T144HDIT	2-5%1 + 1-	2700	30D
550	550T144HDIT	2-5%1 + 1-	3800	30D

**Table 6.4: Three-Phase 60 Hz; Class B  
(IEEE Standard 597-1983); 230 V Delta Primary**

kVA	Catalog No.	Full Capacity Taps	Weight (lbs) [1]	Enclosure [1][2]
<b>230 V Delta Primary, 460Y/265 V Secondary, 150 °C Rise</b>				
7.5	7T143HDIT	2-5%1 + 1-	180	17D
11	11T143HDIT	2-5%1 + 1-	180	17D
15	15T143HDIT	2-5%1 + 1-	190	17D
20	20T143HDIT	2-5%1 + 1-	210	17D
27	27T143HDIT	2-5%1 + 1-	250	17D
34	34T143HDIT	2-5%1 + 1-	295	18D
40	40T143HDIT	2-5%1 + 1-	350	18D
51	51T143HDIT	2-5%1 + 1-	445	20D
63	63T143HDIT	2-5%1 + 1-	465	20D
75	75T143HDIT	2-5%1 + 1-	550	20D
93	93T143HDIT	2-5%1 + 1-	845	22D
118	118T143HDIT	2-5%1 + 1-	920	22D
145	145T143HDIT	2-5%1 + 1-	1025	22D
175	175T143HDIT	2-5%1 + 1-	1120	25D
220	220T143HDIT	2-5%1 + 1-	1200	25D
275	275T143HDIT	2-5%1 + 1-	1500	25D
330	330T143HDIT	2-5%1 + 1-	1390	25D
440	440T143HDIT	2-5%1 + 1-	2700	30D
550	550T143HDIT	2-5%1 + 1-	3800	30D
<b>230 V Delta Primary, 230Y/132 V Secondary, 150 °C Rise</b>				
7.5	7T142HDIT	2-5%1 + 1-	180	17D
11	11T142HDIT	2-5%1 + 1-	180	17D
15	15T142HDIT	2-5%1 + 1-	190	17D
20	20T142HDIT	2-5%1 + 1-	210	17D
27	27T142HDIT	2-5%1 + 1-	250	17D
34	34T142HDIT	2-5%1 + 1-	295	18D
40	40T142HDIT	2-5%1 + 1-	350	18D
51	51T142HDIT	2-5%1 + 1-	445	20D
63	63T142HDIT	2-5%1 + 1-	465	20D
75	75T142HDIT	2-5%1 + 1-	550	20D
93	93T142HDIT	2-5%1 + 1-	845	22D
118	118T142HDIT	2-5%1 + 1-	920	22D
145	145T142HDIT	2-5%1 + 1-	1025	22D
175	175T142HDIT	2-5%1 + 1-	1120	25D
220	220T142HDIT	2-5%1 + 1-	1200	25D
275	275T142HDIT	2-5%1 + 1-	1500	25D
330	330T142HDIT	2-5%1 + 1-	1390	25D
440	440T142HDIT	2-5%1 + 1-	2700	30D
550	550T142HDIT	2-5%1 + 1-	3800	30D

NOTE: Lugs are furnished by customer.

[1] Not for construction. Contact your nearest Schneider Electric sales office for certified prints.  
[2] For enclosure styles, see the dimensions table in Digest Section for Transformers.

### Open Core and Coil Transformers Designed for General Applications for 600 V and Below

Units are designed with 220 °C insulation, aluminum windings, top terminations, compact design to save space, and are UL component recognized for:

- Non-energy efficiency (less than 15 kVA)  
Single-phase 5–10 VA  
Three-phase 3–9 VA
- Energy efficiency (meets Table 4-2 of NEMA TP1–2002)  
Single-phase 15–75 kVA  
Three-phase 15–112.5 kVA

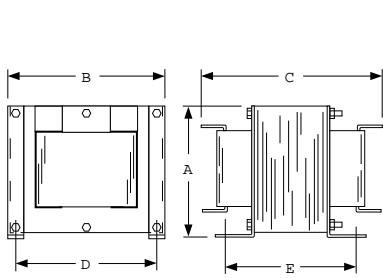

Figure 1

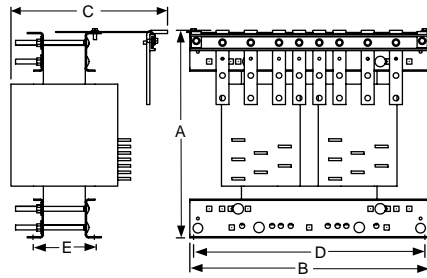

Figure 2

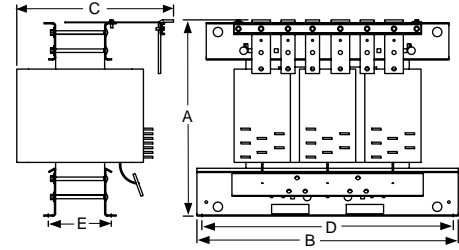

Figure 3

Table 6.5: Single-Phase Open Core and Coil Transformers—240 X 480 V Primary, 120/240 V Secondary, 60 Hz

kVA	Catalog No.	Deg. C Temp. Rise	Full Capacity Taps	Dimensions [3]										Weight (lbs)	Figure		
				A		B		C		D		E[4]					
				in	mm	in	mm	in	mm	in	mm	in	mm	in	mm		
5	5S1HFOC	115	—	8.00	203	9.00	229	11.00	279	8.00	203	8.00	203	66	1		
7.5	7S1HFOC	115	—	8.00	203	9.00	229	14.25	362	8.00	203	8.50	216	80	1		
10	10S1HFOC	115	—	20.50	521	18.5	470	14.00	356	17.0	432	4.25	108	140	2		
15	EE15S3HOC	150	6–2.5% 2+4–[5]	20.50	521	18.5	470	14.00	356	17.0	432	4.25	108	140	2		
25	EE25S3HOC	150	6–2.5% 2+4–[5]	20.25	514	18.5	470	14.00	356	17.0	432	5.00	127	200	2		
37.5	EE37S3HOC	150	6–2.5% 2+4–[5]	22.00	559	18.5	470	18.00	457	17.0	432	5.50	140	255	2		
50	EE50S3HOC	150	6–2.5% 2+4–[5]	22.00	559	18.5	470	18.00	457	17.0	432	6.50	165	310	2		
75	EE75S3HOC	150	6–2.5% 2+4–[5]	22.25	565	28.0	711	22.00	559	27.0	686	8.50	216	460	2		

[3] Not for construction. Contact your nearest Schneider Electric sales office for certified prints.

[4] Dimensions may vary due to manufacturing process.

[5] When 240 V tap is used, there will be 3–5% taps, 1 above and 2 below.



**Table 6.6: Regulation Chart for Type EO Transformers**

VA (60 Hz)	Secondary Voltage					
	Inrush UL VA at 20% Power Factor			Inrush UL VA at 40% Power Factor		
	95%	90%	85%	95%	90%	85%
25	95	—	146	60	—	119
50	164	213	277	123	168	225
75	387	487	622	284	375	798
100	479	606	770	346	463	613
150	755	1177	1532	567	930	1252
200	1260	1883	2419	910	1462	1950
250	1530	2327	2995	1115	1811	2419
300	2030	2981	3800	1455	2290	3038
350	2920	4586	5981	2180	3637	4903
500	4230	5984	7707	3120	4661	6229
750	7430	11460	14736	5380	8907	11891
1000	10300	16873	21734	7450	13145	17571
1500	19200	30042	39217	14500	23859	32179
2000	27750	45194	60022	21750	36901	50994
3000	31800	82333	108205	26750	66072	89509
5000	86100	148768	202077	72600	126887	175552

**Type EO Transformers**

Type EO units are designed with exceptional voltage regulation. These control transformers are constructed using traditional materials and manufacturing techniques, and are designed for 25–5000 VA with a 55 °C temperature rise. When exceptional regulation and very low temperature rise are an absolute necessity, choose Type EO units.

**Table 6.7: Type EO Transformer Dimensions**

VA (60 Hz)	Catalog Number Class 9070	A		B		C		Weight	
		IN	mm	IN	mm	IN	mm	lbs	kg
<b>220x440 V Primary, 110 V Secondary; 230x460 V Primary, 115 V Secondary; or 240x480 V Primary, 120 V Secondary</b>									
25	9070EO17D1	3.31	84	3.00	76	2.50	64	1.9	0.9
50	9070EO1D1	3.31	84	3.00	76	2.50	64	2.2	1.0
75	9070EO18D1	3.78	96	3.38	86	2.81	71	3.5	1.6
100	9070EO2D1	3.78	96	3.38	86	2.81	71	3.8	1.7
150	9070EO3D1	4.44	113	3.75	95	3.13	80	6.0	2.7
200	9070EO19D1	4.81	122	4.50	114	3.75	95	10.5	4.8
250	9070EO15D1	5.19	132	4.50	114	3.75	95	13.2	6.0
300	9070EO4D1	5.56	141	4.50	114	3.75	95	17.2	7.8
500	9070EO51D1	6.56	167	5.25	133	4.38	111	24.5	11.1
750	9070EO61D1	7.94	202	5.25	133	4.38	111	30.5	13.8
1000	9070EO71D1	7.94	202	6.00	152	5.00	127	45.0	20.4
1500	9070EO81D1	8.59	218	7.06	179	6.03	153	56.0	25.4
2000	9070EO91D1	9.22	234	7.06	179	6.03	153	72.0	32.7
3000	9070EO10D1	9.44	239	9.00	229	7.50	191	115.0	52.2
<b>240x480 V Primary, 24 V Secondary</b>									
25	9070EO17D2	3.31	84	3.00	76	2.50	64	1.9	0.9
50	9070EO10D2	3.31	84	3.00	76	2.50	64	2.2	1.0
75	9070EO18D2	3.78	96	3.38	86	2.81	71	3.5	1.6
100	9070EO2D2	3.78	96	3.38	86	2.81	71	3.8	1.7
250	9070EO16D2	6.19	157	4.50	114	3.75	95	13.2	6.0
<b>550 V Primary, 110 V Secondary; 575 V Primary, 115 V Secondary; or 600 V Primary, 120 V Secondary</b>									
200	9070EO19D5	5.56	4.81	122	4.50	114	3.75	10.5	4.8
300	9070EO04D5	5.56	141	4.50	114	3.75	95	17.2	7.8
500	9070EO51D5	6.56	167	5.25	133	4.38	111	24.5	11.1
750	9070EO61D5	7.94	202	5.25	133	4.38	111	30.5	13.8

**Table 6.8: Regulation Chart for Type T Transformers**

VA (60 Hz)	Secondary Voltage					
	Inrush UL VA at 20% Power Factor			Inrush UL VA at 40% Power Factor		
	95%	90%	85%	95%	90%	85%
50	193	266	339	151	215	282
75	271	396	20	210	318	430
100	339	499	659	266	404	549
150	666	893	1120	529	731	942
200	588	815	1041	459	659	866
250	1416	1910	2388	1057	1494	1936
300	1634	2184	2709	1194	1681	2169
350	1894	2592	3261	1392	2005	621
500	3197	4104	4981	2374	3195	4019
750	3770	5515	7231	2887	4391	5945
1000	6587	9079	11430	4706	6886	9051
1500	19324	23983	28607	15066	19361	23756
2000	31384	38777	6161	24794	31630	38667
3000	26539	39934	52713	19355	30721	42216
5000	53111	85265	116277	39368	66309	93882

**Type T and MultiTap™ Transformers**

Type T transformers are designed with low impedance windings for excellent voltage regulation and can accommodate the high inrush current associated with contactors, starters, solenoids, and relays. As the most popular and complete line of control transformers with unmatched design innovations for top performance, Type Ts are manufactured using the most advanced insulating materials and are the best choice if size and cost are of concern. It is available in the MultiTap version, designed to respond to the increased need for voltage and stock flexibility. It combines multiple primary voltages with one or more secondary voltages, all in a single transformer.

**Selection Guide**

- Determine the inrush and sealed VA of each coil in the control circuit, and the VA of all other components.
- Total the sealed VA of all operating coils and the VA of all other loads. (This determines the minimal VA size required for the circuit.)
- Total the inrush VA of all coils that are starting at the same time, and all loads and coils that are running. (Use the regulation chart to give possible units to be used.)
- Taking the VA size from step 2, go to the standard VA size in the chart. Make sure the inrush VA from the chart is greater than the total VA from step 3. (If not, go to the next larger VA size and repeat.)

If your supply voltage is stable and fluctuates less than 5%, we recommend you use the 90% secondary voltage column. If your supply voltage is not stable and fluctuates more than 10%, we recommend you use the 95% secondary voltage column. We recommend that you never use the 85% secondary voltage column since magnetic devices lose life expectancy if they are continuously started at 85% of rated voltage.

**Table 6.9: Type T Transformer Selection**

VA	UL/CSA/NOM	CE	Catalog No.	H	W	D	Weight (lbs)
				in (mm)	in (mm)	in (mm)	
<b>120 V Primary, 120 V Secondary; 115 V Primary, 115 V Secondary; or 110 V Primary, 110 V Secondary</b>							
50		50	9070T50D24	2.58 (65.5)	3.00 (76.2)	3.09 (78.5)	2.5
75		75	9070T75D24	2.89 (73.4)	3.38 (85.8)	3.34 (84.8)	3.8
100		100	9070T100D24	2.89 (73.4)	3.38 (85.8)	3.34 (84.8)	3.8
150		150	9070T150D24	3.20 (81.3)	3.75 (95.3)	3.59 (91.2)	5.5
200		200	9070T200D24	3.20 (81.3)	3.75 (95.3)	3.59 (91.2)	5.5
250		160	9070T250D24	3.25 (82.6)	3.75 (95.3)	5.25 (133.4)	7.1
300		200	9070T300D24	3.80 (96.5)	4.50 (114.3)	4.70 (119.4)	8.5
350		250	9070T350D24	3.80 (96.5)	4.50 (114.3)	5.09 (129.3)	10.5
500		300	9070T500D24	3.80 (96.5)	4.50 (114.3)	5.46 (138.7)	11.9
750		500	9070T750D24	4.43 (112.5)	5.25 (133.4)	5.66 (143.8)	11.0
1000		630	9070T1000D24	4.43 (112.5)	5.25 (133.4)	6.04 (153.4)	20.6
1500		1000	9070T1500D24	6.16 (156.5)	7.06 (179.3)	5.81 (147.6)	34.0
2000		1500	9070T2000D24	6.16 (156.5)	7.06 (179.3)	7.04 (178.8)	47.0

Table 6.9 Type T Transformer Selection (cont'd.)

VA		Catalog No.	H	W	D	Weight (lbs)
UL/CSA/NOM	CE		in (mm)	in (mm)	in (mm)	
3000	2000	9070T3000D24	8.46 (214.9)	9.00 (228.6)	6.86 (174.2)	60.0
5000	3000	9070T5000D24	8.46 (214.9)	9.00 (228.6)	8.73 (221.7)	89.0
<b>120 V x 240 V Primary, 120/240 V Secondary; 115 V x 230 V Primary, 115/230 V Secondary; or 110 V x 220 V Primary, 110/220 V Secondary</b>						
50	50	9070T50D55	2.58 (65.5)	3.00 (76.2)	3.09 (78.5)	2.5
75	75	9070T75D55	2.89 (73.4)	3.38 (85.8)	3.34 (84.8)	3.8
100	100	9070T100D55	2.89 (73.4)	3.38 (85.8)	3.34 (84.8)	3.8
150	150	9070T150D55	3.20 (81.3)	3.75 (95.3)	3.59 (91.2)	5.5
200	200	9070T200D55	3.20 (81.3)	3.75 (95.3)	3.59 (91.20)	5.5
250	160	9070T250D55	3.25 (82.6)	3.75 (95.3)	5.25 (133.4)	7.1
300	200	9070T300D55	3.80 (96.5)	4.50 (114.3)	4.70 (119.4)	8.5
350	250	9070T350D55	3.80 (96.5)	4.50 (114.3)	5.09 (129.3)	10.5
500	300	9070T500D55	3.80 (96.5)	4.50 (114.3)	5.46 (138.7)	11.9
750	500	9070T750D55	4.43 (112.5)	5.25 (133.4)	5.66 (143.8)	11.0
1000	630	9070T1000D55	4.43 (112.5)	5.25 (133.4)	6.04 (153.4)	20.6
1500	1000	9070T1500D55	6.16 (156.5)	7.06 (179.3)	5.81 (147.6)	34.0
2000	1500	9070T2000D55	6.16 (156.5)	7.06 (179.3)	7.04 (178.8)	47.0
3000	2000	9070T3000D55	8.46 (214.9)	9.00 (228.6)	6.86 (174.2)	60.0
5000	3000	9070T5000D55	8.46 (214.9)	9.00 (228.6)	8.73 (221.7)	89.0
<b>277 V Primary, 24 V Secondary</b>						
50	50	9070T50D25	2.58 (65.5)	3.00 (76.2)	3.09 (78.5)	2.5
75	75	9070T75D25	2.89 (73.4)	3.38 (85.8)	3.34 (84.8)	3.8
100	100	9070T100D25	2.89 (73.4)	3.38 (85.8)	3.34 (84.8)	3.8
150	150	9070T150D25	3.20 (81.3)	3.75 (95.3)	3.59 (91.2)	5.5
200	200	9070T200D25	3.20 (81.3)	3.75 (95.3)	3.59 (91.20)	5.5
250	160	9070T250D25	3.25 (82.6)	3.75 (95.3)	5.25 (133.4)	7.1
300	200	9070T300D25	3.80 (96.5)	4.50 (114.3)	4.70 (119.4)	8.5
350	250	9070T350D25	3.80 (96.5)	4.50 (114.3)	5.09 (129.3)	10.5
500	300	9070T500D25	3.80 (96.5)	4.50 (114.3)	5.46 (138.7)	11.9
750	500	9070T750D25	4.43 (112.5)	5.25 (133.4)	5.66 (143.8)	11.0
1000	630	9070T1000D25	4.43 (112.5)	5.25 (133.4)	6.04 (153.4)	20.6
<b>600 V Primary, 12/24 V Secondary</b>						
50	50	9070T50D36	2.58 (65.5)	3.00 (76.2)	3.09 (78.5)	2.5
75	75	9070T75D36	2.89 (73.4)	3.38 (85.8)	3.34 (84.8)	3.8
100	100	9070T100D36	2.89 (73.4)	3.38 (85.8)	3.34 (84.8)	3.8
150	150	9070T150D36	3.20 (81.3)	3.75 (95.3)	3.59 (91.2)	5.5
200	200	9070T200D36	3.20 (81.3)	3.75 (95.3)	3.59 (91.20)	5.5
250	160	9070T250D36	3.25 (82.6)	3.75 (95.3)	5.25 (133.4)	7.1
300	200	9070T300D36	3.80 (96.5)	4.50 (114.3)	4.70 (119.4)	8.5
350	250	9070T350D36	3.80 (96.5)	4.50 (114.3)	5.09 (129.3)	10.5
500	300	9070T500D36	3.80 (96.5)	4.50 (114.3)	5.46 (138.7)	11.9
750	500	9070T750D36	4.43 (112.5)	5.25 (133.4)	5.66 (143.8)	11.0
1000	630	9070T1000D36	4.43 (112.5)	5.25 (133.4)	6.04 (153.4)	20.6
<b>480 V Primary, 240 V Secondary; 460 V Primary, 230 V Secondary; or 440 V Primary, 220 V Secondary</b>						
50	50	9070T50D12	2.58 (65.5)	3.00 (76.2)	3.09 (78.5)	2.5
75	75	9070T75D12	2.89 (73.4)	3.38 (85.8)	3.34 (84.8)	3.8
100	100	9070T100D12	2.89 (73.4)	3.38 (85.8)	3.34 (84.8)	3.8
150	150	9070T150D12	3.20 (81.3)	3.75 (95.3)	3.59 (91.2)	5.5
200	200	9070T200D12	3.20 (81.3)	3.75 (95.3)	3.59 (91.2)	5.5
250	160	9070T250D12	3.25 (82.6)	3.75 (95.3)	5.25 (133.4)	7.1
300	200	9070T300D12	3.80 (96.5)	4.50 (114.3)	4.70 (119.4)	8.5
350	250	9070T350D12	3.80 (96.5)	4.50 (114.3)	5.09 (129.3)	10.5
500	300	9070T500D12	3.80 (96.5)	4.50 (114.3)	5.46 (138.7)	11.9
750	500	9070T750D12	4.43 (112.5)	5.25 (133.4)	5.66 (143.8)	11.0
1000	630	9070T1000D12	4.43 (112.5)	5.25 (133.4)	6.04 (153.4)	20.6
1500	1000	9070T1500D12	6.16 (156.5)	7.06 (179.3)	5.81 (147.6)	34.0
2000	1500	9070T2000D12	6.16 (156.5)	7.06 (179.3)	7.04 (178.8)	47.0
3000	2000	9070T3000D12	8.46 (214.9)	9.00 (228.6)	6.86 (174.2)	60.0
5000	3000	9070T5000D12	8.46 (214.9)	9.00 (228.6)	8.73 (221.7)	89.0



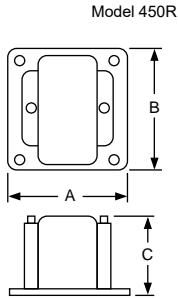

**Voltage Transformers**

These voltage transformers are designed for line-to-line or line-to-ground connection on the primary voltage indicated. See [Table 6.10 Voltage Transformers, UR/cUR Recognized, 60 Hz](#), page 6-9 to determine the applicable configuration for proper system voltage indication.

- **Model 450R**—designed for switchboard use. This model features high accuracy and burden capacity for excellent performance in metering and indication.
- **Model 460R**—a compact, lightweight design, providing exceptional performance in indicating applications.
- **Model 470R**—a compact, low cost design optimized for maximum accuracy and performance when used with Powerlogic™ circuit monitors.

**Table 6.10: Voltage Transformers, UR/cUR Recognized, 60 Hz**

Model 450R Thermal Rating: 500 VA @ 30 °C; 300 VA @ 55 °C; Accuracy 0.3W. X.M & Y: 1.2 Z	Model 460R Thermal Rating: 150 VA @ 30 °C; 100 VA @ 55 °C. Accuracy 0.6W. 1.2 X	Model 470R Thermal Rating: 150 VA @ 30 °C; 100 VA @ 55 °C. Accuracy 0.3W. 1.2 X	System Voltage	Winding Ratio
Catalog Number	Catalog Number	Catalog Number		
450R069	460R069	470R069	69/120Y	0.58:1
450R120	460R120	470R120	120/208Y	1:1
450R208	460R208	470R208	120/208Y	1.73:1
450R240	460R240	470R240	240/416Y	2:1
450R288	460R288	470R288	288/500Y <sup>[1]</sup>	2.4:1
450R300	460R300	470R300	300/520Y	2.5:1
450R380	460R380	470R380	220/380Y	3.17:1
450R480	460R480	470R480	480/480Y <sup>[2]</sup>	4:1
450R600	460R600	470R600	600/600Y	5:1

Model	Dimensions (inches)		
	A	B	C
450R	6	7-1/8	5-7/8
460R	4-3/4	4-1/2	3-7/8
470R	4-3/4	4-1/2	3-7/8

**Current Transformers**

**Table 6.12: General Purpose Compact Units, UR/cUR Recognized**

Window Size (inches)	Catalog Number (without brackets)	Current Rating (Amperes)	VA 60 Hz	VA 400 Hz	Accuracy (At Rated Current)	Rating Factor 30 °C Ambient
1-1/8	2NR500	50:5	1.0	2.0	= 2%	1.0
	2NR600	60:5	1.0	2.0	= 2%	1.0
	2NR750	75:5	1.5	3.0	= 2%	1.0
	2NR800	80:5	1.5	3.0	= 2%	1.0
	2NR101	100:5	2.0	4.0	= 1%	1.0
	2NR121	120:5	2.5	5.0	= 1%	1.0
	2NR1250	125:5	2.5	5.0	= 1%	1.0
	2NR151	150:5	2.5	5.0	= 1%	1.0
	2NR201	200:5	2.5	5.0	= 1%	1.0
	2NR251	250:5	2.5	5.0	= 1%	1.0
1-9/16	2NR301	300:5	2.5	5.0	= 1%	1.0
	5NR101	100:5	2.0	4.0	= 1%	1.0
	5NR151	150:5	2.5	5.0	= 1%	1.0
	5NR201	200:5	5.0	12.5	= 1%	1.0
	5NR251	250:5	5.0	12.5	= 1%	1.0
	5NR301	300:5	5.0	12.5	= 1%	1.0
	5NR401	400:5	12.5	25.0	= 1%	1.0
	5NR501	500:5	12.5	25.0	= 1%	1.0
1-9/16	5NR601	600:5	25.0	50.0	= 1%	1.0
	54R101	100:5	2.0	4.0	= 1%	1.0
	54R151	150:5	2.5	5.0	= 1%	1.0
	54R201	200:5	5.0	12.5	= 1%	1.0
	54R251	250:5	5.0	12.5	= 1%	1.0
	54R301	300:5	5.0	12.5	= 1%	1.0
	54R401	400:5	12.5	25.0	= 1%	1.0
	54R501	500:5	12.5	25.0	= 1%	1.0
2-1/4	54R601	600:5	25.0	50.0	= 1%	1.0
	7RL500	50:5	2.5	5.0	= 1%	1.5
	7RL101	100:5	2.5	5.0	= 1%	1.5
	7RL151	150:5	2.5	5.0	= 1%	1.5
	7RL201	200:5	5.0	10.0	= 1%	1.5
	7RL251	250:5	5.0	10.0	= 1%	1.5
	7RL301	300:5	5.0	10.0	= 1%	1.5
	7RL401	400:5	12.5	25.0	= 1%	1.5
	7RL501	500:5	12.5	25.0	= 1%	1.5
	7RL601	600:5	12.5	25.0	= 1%	1.5
	7RL751	750:5	12.5	25.0	= 1%	1.5
	7RL801	800:5	12.5	25.0	= 1%	1.5
7RL102	1000:5	25.0	50.0	= 1%	1.5	
7RL122	1200:5	25.0	50.0	= 1%	1.5	
7RL152	1500:5	25.0	50.0	= 1%	1.5	

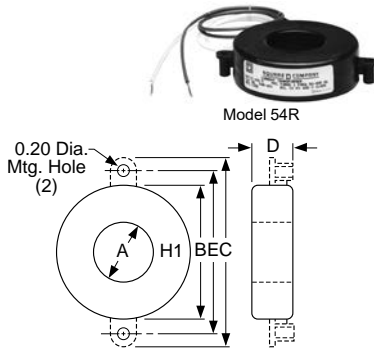

**Table 6.11: Dimensions for Models 2NR, 5NR, 54R, and 7RL**

Model	Dimensions (inches)				
	A	B	C	D	E
2NR	1.13	2.38	—	.94	—
5NR	1.56	3.50	—	1.06	—
54R	1.56	3.50	4.56	1.06	4.00
7RL	2.25	4.38	—	1.38	—

[1] For use on 277/480 Wye systems.  
[2] For use on 480 V Delta systems.

Toroidal Current Transformers (64R, 74R, 66R, 76R)

Table 6.14: Toroidal Current Transformers, UR/cUR Recognized, 25–400 Hz

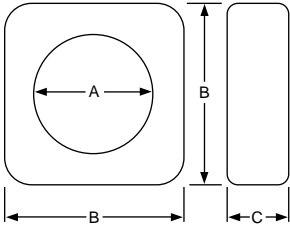

Models 64R, 66R, 74R, 76R,  
Table 6.13: Dimensions for 64R, 66R, 74R, and 76R

Model	Dimensions (inches)		
	A	B	C
64R	1-15/16	4-3/16	1-1/2
66R	1-15/16	4-3/16	31/16
74R	2-11/32	4-11/16	1-5/8
76R	2-11/32	4-11/16	3-1/4

Window Size (inches)	Catalog Number (without brackets) [3]	Current Rating (Amperes)	Relay Class	ANSI Accuracy Classification—60 Hz Metering Class					Rating Factor 30 °C Ambient
				B-0.1	B-0.2	B-0.5	B-0.9	B-1.8	
1-15/16	64R101	100:5	—	1.2	2.4	—	—	—	1.33
	64R151	150:0	—	1.2	1.2	—	—	—	1.33
	64R201	200:5	—	1.2	1.2	2.4	—	—	1.33
	64R251	250:5	—	0.6	0.6	1.2	—	—	1.33
	64R301	300:5	—	0.6	0.6	1.2	2.4	—	1.33
	64R401	400:5	—	0.3	0.6	0.6	1.2	—	1.33
	64R501	500:5	—	0.3	0.3	0.6	0.6	—	1.33
	64R601	600:5	—	0.3	0.3	0.3	0.6	1.2	1.33
1-15/16	66R101	100:5	—	1.2	2.4	—	—	—	1.33
	66R151	150:0	—	0.6	1.2	2.4	2.4	—	1.33
	66R201	200:5	C10	0.6	0.6	1.2	2.4	—	1.33
	66R251	250:5	C10	0.3	0.6	0.6	1.2	2.4	1.33
	66R301	300:5	C10	0.3	0.3	0.6	1.2	2.4	1.33
	66R401	400:5	C10	0.3	0.3	0.3	0.6	1.2	1.33
	66R501	500:5	C20	0.3	0.3	0.3	0.6	0.6	1.33
	66R601	600:5	C20	0.3	0.3	0.3	0.3	0.6	1.33
2-11/32	74R201	200:5	—	1.2	1.2	0.6	—	—	1.33
	74R251	250:5	—	1.2	1.2	0.6	1.2	—	1.33
	74R301	300:5	—	0.6	0.6	1.2	2.4	—	1.33
	74R401	400:5	—	0.3	0.3	0.6	1.2	—	1.33
	74R501	500:5	—	0.3	0.3	0.6	0.6	1.2	1.33
	74R601	600:5	—	0.3	0.3	0.3	0.6	1.2	1.33
	74R751	750:5	—	0.3	0.3	0.6	0.6	1.2	1.33
	74R801	800:5	—	0.3	0.3	0.3	0.6	1.2	1.33
	74R102	1000:5	—	0.3	0.3	0.3	0.3	0.6	1.33
	74R122	1200:5	—	0.3	0.3	0.3	0.3	0.6	1.33
2-11/32	76R152	1500:5	—	0.3	0.3	0.3	0.3	0.6	1.00
	76R201	200:5	C10	0.6	0.6	1.2	2.4	2.4	1.33
	76R251	250:5	C10	0.3	0.6	1.2	1.2	2.4	1.33
	76R301	300:5	C10	0.3	0.3	0.6	1.2	1.2	1.33
	76R401	400:5	C10	0.3	0.3	0.3	0.6	1.2	1.33
	76R501	500:5	C10	0.3	0.3	0.3	0.3	0.6	1.33
	76R601	600:5	C20	0.3	0.3	0.3	0.3	0.6	1.33
	76R751	750:5	C20	0.3	0.3	0.3	0.3	0.6	1.33
	76R801	800:5	C20	0.3	0.3	0.3	0.3	0.3	1.33
	76R102	1000:5	C20	0.3	0.3	0.3	0.3	0.3	1.33

Toroidal Current Transformers (100R, 110R, 120R, 140R)

Table 6.16: Toroidal Current Transformers, UR/cUR Recognized, 25–400 Hz



Models 100R, 110R, 120R, 140R

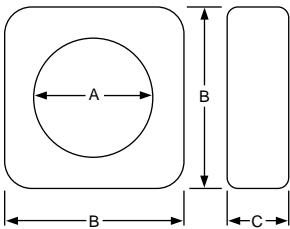

100R, 110R, 120R, and 140R  
Table 6.15: Dimensions for 100R, 110R, 120R, and 140R

Model	Dimensions (inches)		
	A	B	C
100R	4	7	2-1/8
110R	4	7	2-7/8
120R	5-3/4	8-1/2	2-1/8
140R	8-1/8	11	3

Window Size (inches)	Catalog Number (without brackets) [3]	Current Rating (Amperes)	Relay Class	ANSI Accuracy Classification—60 Hz Metering Class					Rating Factor 30 °C Ambient
				B-0.1	B-0.2	B-0.5	B-0.9	B-1.8	
4	100R201	200:5	C10	0.6	1.2	2.4	—	—	1.33
	100R301	300:5	C10	0.3	0.6	1.2	1.2	2.4	1.33
	100R401	400:5	C20	0.3	0.3	0.6	1.2	1.2	1.33
	100R501	500:5	C20	0.3	0.3	0.6	0.6	1.2	1.33
	100R601	600:5	C20	0.3	0.3	0.3	0.6	0.6	1.33
	100R801	800:5	C20	0.3	0.3	0.3	0.3	0.6	1.33
	100R102	1000:5	C50	0.3	0.3	0.3	0.3	0.3	1.33
	100R122	1200:5	C50	0.3	0.3	0.3	0.3	0.3	1.33
	100R152	1500:5	C50	0.3	0.3	0.3	0.3	0.3	1.33
	100R162	1600:5	C50	0.3	0.3	0.3	0.3	0.3	1.33
	100R202	2000:5	C50	0.3	0.3	0.3	0.3	0.3	1.33
	4	110R201	200:5	C20	0.6	0.6	1.2	2.4	—
110R301		300:5	C20	0.3	0.3	0.6	1.2	2.4	1.33
110R401		400:5	C20	0.3	0.3	0.3	0.6	1.2	1.33
110R501		500:5	C50	0.3	0.3	0.3	0.6	0.6	1.33
110R601		600:5	C50	0.3	0.3	0.3	0.6	0.6	1.33
110R801		800:5	C50	0.3	0.3	0.3	0.3	0.3	1.33
110R102		1000:5	C100	0.3	0.3	0.3	0.3	0.3	1.33
110R122		1200:5	C100	0.3	0.3	0.3	0.3	0.3	1.33
110R152		1500:5	C100	0.3	0.3	0.3	0.3	0.3	1.33
110R162		1600:5	C100	0.3	0.3	0.3	0.3	0.3	1.33
110R202		2000:5	C100	0.3	0.3	0.3	0.3	0.3	1.33
5-3/4		120R201	200:5	C10	1.2	2.4	2.4	—	—
	120R301	300:5	C10	0.6	1.2	2.4	2.4	—	1.33
	120R401	400:5	C20	0.3	0.6	1.2	1.2	2.4	1.33
	120R501	500:5	C20	0.3	0.3	0.6	1.2	2.4	1.33
	120R601	600:5	C20	0.3	0.3	0.6	0.6	1.2	1.33
	120R801	800:5	C20	0.3	0.3	0.3	0.6	0.6	1.33
	120R102	1000:5	C50	0.3	0.3	0.3	0.3	0.6	1.33
	120R122	1200:5	C50	0.3	0.3	0.3	0.3	0.3	1.33
	120R152	1500:5	C50	0.3	0.3	0.3	0.3	0.3	1.33
	120R162	1600:5	C50	0.3	0.3	0.3	0.3	0.3	1.33
	120R202	2000:5	C50	0.3	0.3	0.3	0.3	0.3	1.33
	120R252	2500:5	C50	0.3	0.3	0.3	0.3	0.3	1.33
5-3/4	120R302	3000:5	C50	0.3	0.3	0.3	0.3	0.3	1.33
	120R402	4000:5	—	0.3	0.3	0.3	0.3	0.3	1.00

[3] For mounting brackets, refer to Bushing Current Transformers 50–400 Hz, page 6-14

**Table 6.16 Toroidal Current Transformers, UR/cUR Recognized, 25–400 Hz (cont'd.)**

Window Size (inches)	Catalog Number (without brackets) [4]	Current Rating (Amperes)	Relay Class	ANSI Accuracy Classification—60 Hz Metering Class					Rating Factor 30 °C Ambient
				B-0.1	B-0.2	B-0.5	B-0.9	B-1.8	
8-1/8	140R500	50:5	—	For Ground Fault Sensing					1.33
	140R101	100:5	—	—					1.33
8-1/8	140R401	400:5	C20	0.6	0.6	1.2	1.2	2.4	1.33
	140R501	500:5	C20	0.3	0.3	0.6	1.2	1.2	1.33
	140R601	600:5	C20	0.3	0.3	0.6	0.6	1.2	1.33
	140R801	800:5	C50	0.3	0.3	0.3	0.6	0.6	1.33
	140R102	1000:5	C50	0.3	0.3	0.3	0.3	0.6	1.33
	140R122	1200:5	C100	0.3	0.3	0.3	0.3	0.3	1.33
	140R152	1500:5	C100	0.3	0.3	0.3	0.3	0.3	1.33
	140R202	2000:5	C100	0.3	0.3	0.3	0.3	0.3	1.33
	140R252	2500:5	C100	0.3	0.3	0.3	0.3	0.3	1.33
	140R302	3000:5	C100	0.3	0.3	0.3	0.3	0.3	1.33
	140R402	4000:5	C100	0.3	0.3	0.3	0.3	0.3	1.33
	140R502	5000:5	C100	0.3	0.3	0.3	0.3	0.3	1.00
	140R602	6000:5	C100	0.3	0.3	0.3	0.3	0.3	1.00

**Toroidal Current Transformers (152R, 170R, 180R, 210R)**

**Table 6.18: Toroidal Current Transformers, UR/cUR Recognized, 25–400 Hz**

Window Size (inches)	Catalog Number (without brackets) [4]	Current Rating (Amperes)	Relay Class	ANSI Accuracy Classification—60 Hz Metering Class					Rating Factor 30 °C Ambient
				B-0.1	B-0.2	B-0.5	B-0.9	B-1.8	
6-7/8	152R500	50:5	C10	1.2	—	—	—	—	1.33
	152R101	100:5	C20	1.2	2.4	—	—	—	1.33
	152R151	150:5	C50	0.6	1.2	2.4	—	—	1.33
	152R201	200:5	C50	0.6	0.6	1.2	2.4	2.4	1.33
	152R251	250:5	C50	0.3	0.6	0.6	1.2	2.4	1.33
	152R301	300:5	C100	0.3	0.3	0.6	1.2	1.2	1.33
	152R401	400:5	C100	0.3	0.3	0.3	0.6	1.2	1.33
	152R501	500:5	C100	0.3	0.3	0.3	0.3	0.6	1.33
	152R601	600:5	C200	0.3	0.3	0.3	0.3	0.6	1.33
	152R801	800:5	C200	0.3	0.3	0.3	0.3	0.3	1.33
	152R102	1000:5	C200	0.3	0.3	0.3	0.3	0.3	1.33
	152R122	1200:5	C400	0.3	0.3	0.3	0.3	0.3	1.33
	152R152	1500:5	C400	0.3	0.3	0.3	0.3	0.3	1.33
	152R162	1600:5	C400	0.3	0.3	0.3	0.3	0.3	1.33
152R202	2000:5	C400	0.3	0.3	0.3	0.3	0.3	1.33	
152R252	2500:5	C400	0.3	0.3	0.3	0.3	0.3	1.33	
4-1/4	152R302	3000:5	C400	0.3	0.3	0.3	0.3	0.3	1.33
	152R402	4000:5	C800	0.3	0.3	0.3	0.3	0.3	1.33
	170R201	200:5	—	1.2	0.6	2.4	—	—	1.33
	170R251	250:5	—	0.6	0.6	2.4	—	—	1.33
	170R301	300:5	—	0.6	0.6	1.2	2.4	—	1.33
	170R401	400:5	—	0.6	0.6	0.6	1.2	—	1.33
	170R501	500:5	—	0.3	0.6	0.6	1.2	—	1.33
	170R601	600:5	—	0.3	0.3	0.6	1.2	2.4	1.33
	170R751	750:5	C10	0.3	0.3	0.6	0.6	1.2	1.33
	170R801	800:5	C10	0.3	0.3	0.3	0.6	1.2	1.33
	170R102	1000:5	C10	0.3	0.3	0.3	0.3	0.6	1.33
	170R122	1200:5	C10	0.3	0.3	0.3	0.3	0.6	1.33
	170R152	1500:5	—	0.3	0.3	0.3	0.3	0.6	1.33
	170R162	1600:5	—	0.3	0.3	0.3	0.3	0.6	1.33
170R202	2000:5	—	0.3	0.3	0.3	0.3	0.3	1.33	
170R252	2500:5	—	0.3	0.3	0.3	0.3	0.3	1.33	
2-1/2	180R101	100:5	—	2.4	2.4	—	—	—	1.33
	180R151	150:5	—	1.2	2.4	—	—	—	1.33
	180R201	200:5	—	1.2	1.2	2.4	—	—	1.33
	180R251	250:5	—	0.6	1.2	2.4	2.4	—	1.33
	180R301	300:5	—	0.6	0.6	1.2	2.4	—	1.33
	180R401	400:5	—	0.3	0.3	0.6	1.2	2.4	1.33
	180R501	500:5	—	0.3	0.3	0.6	0.6	1.2	1.33
	180R601	600:5	—	0.3	0.3	0.3	0.6	1.2	1.33
	180R751	750:5	—	0.3	0.3	0.3	0.3	0.6	1.33
	180R801	800:5	—	0.3	0.3	0.3	0.6	1.2	1.33
2-1/2	180R102	1000:5	—	0.3	0.3	0.3	0.6	0.6	1.33
	180R122	1200:5	—	0.3	0.3	0.3	0.3	0.6	1.33
	180R152	1500:5	—	0.3	0.3	0.3	0.3	0.3	1.33
	210R122	1200:5	C100	0.3	0.3	0.3	0.3	0.3	1.33
	210R162	1600:5	C100	0.3	0.3	0.3	0.3	0.3	1.33
	210R202	2000:5	C100	0.3	0.3	0.3	0.3	0.3	1.33
	210R252	2500:5	C200	0.3	0.3	0.3	0.3	0.3	1.33
	210R302	3000:5	C200	0.3	0.3	0.3	0.3	0.3	1.0
210R402	4000:5	C200	0.3	0.3	0.3	0.3	0.3	1.0	

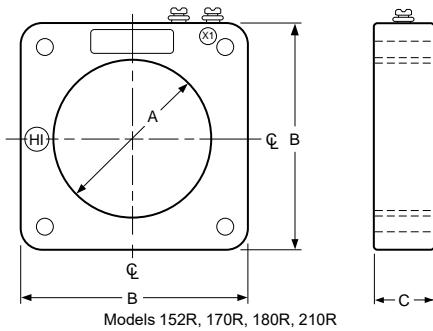

**Table 6.17: Dimensions for Models 152R, 170R, 180R, and 210R**

Model	Dimensions (inches)		
	A	B	C
152R	6.88	12.25	4.12
170R	4.25	6.75	1.31
180R	2.50	4.50	2.12
210R	6.25	9.50	2.87

[4] For mounting brackets, refer to Bushing Current Transformers 50–400 Hz, page 6-14

Toroidal Current Transformers (200R, 201R, 202R, 203R)

Table 6.20: Toroidal Current Transformers, UR/cUR Recognized, 25–400 Hz

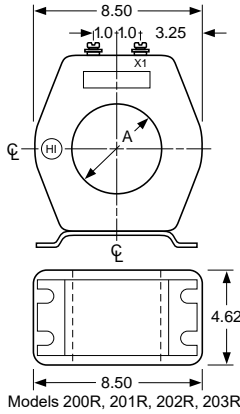

Models 200R, 201R, 202R, 203R

Table 6.19: Dimensions for Models 200R, 201R, 202R, and 203R

Model [5]	Dimensions A (inches)
200R	2.50
201R	3.50
202R	4.50
203R	5.25

Window Size (inches)	Catalog Number (without brackets) [6]	Current Rating (Amperes)	Relay Class	ANSI Accuracy Classification—60 Hz Metering Class					Rating Factor 30 °C Ambient
				B-0.1	B-0.2	B-0.5	B-0.9	B-1.8	
2-1/2	200R101	100:5	C50	0.6	1.2	1.2	—	—	1.5
	200R151	150:0	C50	0.3	0.6	0.6	1.2	2.4	1.5
	200R201	200:5	C100	0.3	0.3	0.6	1.2	1.2	1.5
	200R251	250:5	C100	0.3	0.3	0.3	0.6	1.2	1.5
	200R301	300:5	C100	0.3	0.3	0.3	0.3	0.6	1.5
	200R401	400:5	C200	0.3	0.3	0.3	0.3	0.3	1.5
3-1/2	201R101	100:5	C20	1.2	1.2	2.4	2.4	—	1.5
	201R151	150:5	C50	0.3	0.6	1.2	2.4	2.4	1.5
	201R201	200:5	C50	0.3	0.3	0.6	1.2	2.4	1.5
	201R251	250:5	C100	0.3	0.3	0.6	1.2	1.2	1.5
	201R301	300:5	C100	0.3	0.3	0.3	0.6	1.2	1.5
	201R401	400:5	C100	0.3	0.3	0.3	0.3	0.6	1.5
4-1/2	202R101	100:5	C20	1.2	2.4	2.4	—	—	1.5
	202R151	150:5	C20	1.2	1.2	2.4	2.4	—	1.5
	202R201	200:5	C50	0.3	0.6	1.2	1.2	2.4	1.5
	202R251	250:5	C50	0.3	0.3	0.6	1.2	1.2	1.5
	202R301	300:5	C50	0.3	0.3	0.6	0.6	1.2	1.5
	202R401	400:5	C100	0.3	0.3	0.3	0.3	0.6	1.5
5-1/4	203R101	100:5	C20	1.2	2.4	—	—	—	1.5
	203R151	150:5	C20	0.6	1.2	2.4	2.4	—	1.5
	203R201	200:5	C20	0.3	0.6	1.2	2.4	2.4	1.5
	203R251	250:5	C20	0.3	0.6	1.2	1.2	2.4	1.5
	203R301	300:5	C50	0.3	0.3	0.6	1.2	1.2	1.5
	203R401	400:5	C50	0.3	0.3	0.6	0.6	1.2	1.5
5-1/4	203R501	500:5	C100	0.3	0.3	0.3	0.3	0.6	1.5
	203R601	600:5	C100	0.3	0.3	0.3	0.3	0.6	1.5
	203R751	750:5	C100	0.3	0.3	0.3	0.3	0.3	1.5
	203R801	800:5	C100	0.3	0.3	0.3	0.3	0.3	1.5
	203R102	1000:5	C200	0.3	0.3	0.3	0.3	0.3	1.5
	203R122	1200:5	C200	0.3	0.3	0.3	0.3	0.3	1.5
	203R152	1500:5	C200	0.3	0.3	0.3	0.3	0.3	1.5
	203R162	1600:5	C200	0.3	0.3	0.3	0.3	0.3	1.33
	203R202	2000:5	C200	0.3	0.3	0.3	0.3	0.3	1.33
	203R252	2500:5	C200	0.3	0.3	0.3	0.3	0.3	1.33
	203R302	3000:5	C200	0.3	0.3	0.3	0.3	0.3	1.33

Shorting Terminal Blocks

Table 6.21: Shorting Terminal Blocks

Catalog No.	Description
3090TB4	Shorting terminal block (4-pole)
3090TB6	Shorting terminal block (6-pole)

Multi-Ratio Current Transformers

Table 6.23: Multi-Ratio Transformers, UR/cUR Recognized 60 Hz-Model 312R, 25–400 Hz-Model 151R

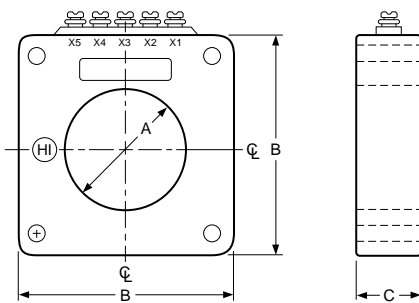

Models 151R, 312R

Table 6.22: Dimensions for Models 151R and 312R

Model	Dimensions (inches)		
	A	B	C
151R	6.88	12.25	4.12
312R	4.50	11.00	2.38

Window Size (inches)	Catalog Number (without brackets) [6]	Current Rating [7] (Amperes)	Relay Class [8]	ANSI Accuracy Classification – 60 Hz Metering Class					Rating Factor 30 °C Ambient
				B-0.1	B-0.2	B-0.5	B-0.9	B-1.8	
4-1/2	312R601	600:5MR	C100	—	—	—	—	—	1.5
	312R122	1200:5MR	C200	—	—	—	—	—	1.5
	312R202	2000:5MR	C400	—	—	—	—	—	1.5
	312R302	3000:5MR	C400	—	—	—	—	—	1.5
	312R402	4000:5MR	C400	—	—	—	—	—	1.33
	6-7/8	151R601	600:5MR	C200	—	—	—	—	—
151R122		1200:5MR	C400	—	—	—	—	—	1.33
151R202		2000:5MR	C400	—	—	—	—	—	1.33
151R302		3000:5MR	C400	—	—	—	—	—	1.33
151R402		4000:5MR	C800	—	—	—	—	—	1.33

Table 6.24: Multi-Ratio Taps (Models 151R, 312R, 781R, 786R)

Nominal Ratio	Current Ratio [9] (Amperes)
600:5	600/500/450/400/300/250/200/150/100/50:5
1200:5	1200/1000/900/800/600/500/400/300/200/100:5
2000:5	2000/1600/1500/1200/1100/800/500/400/300:5
3000:5	3000/2500/2200/2000/1500/1200/1000/800/500/300:5
4000:5	4000/3500/3000/2500/2000/1500/1000/500

[5] Base is included.

[6] For mounting brackets, refer to Bushing Current Transformers 50–400 Hz, page 6-14

[7] For multi-ratio (MR) taps, refer to the Multi-Ratio Taps table.

[8] Relay class applies to nominal ratio only.

[9] Taps in accordance with ANSI C57.13 and NEMA SG-4.

**Rectangular Window Current Transformers**

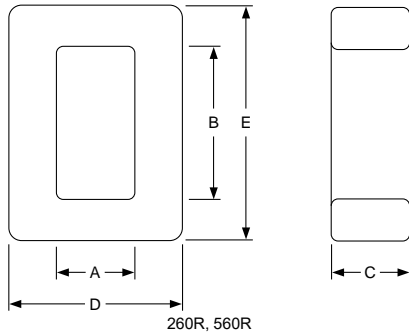

260R, 560R

**Table 6.25: Dimensions for Models 260R, and 560R**

Model	Dimensions (inches)				
	A	B	C	D	E
260R	2.13	4.25	2.12	4.88	7.25
560R	3.75	7.45	1.13	5.53	11.19

**Table 6.26: Rectangular Window Transformers, UR/cUR Recognized, 50–400 Hz**

Window Size (inches)	Catalog Number (without brackets) [10]	Current Rating (Amperes)	ANSI Accuracy Classification—60 Hz Metering Class					Rating Factor 30 °C Ambient
			B-0.1	B-0.2	B-0.5	B-0.9	B-1.8	
2-1/8 x 4-1/4	260R101	100:5	1.2	2.4	—	—	—	1.33
	260R151	150:5	1.2	2.4	—	—	—	1.33
	260R201	200:5	1.2	1.2	—	—	—	1.33
	260R301	300:5	0.6	0.6	—	—	—	1.33
	260R401	400:5	0.6	0.6	—	—	—	1.33
	260R601	600:5	0.3	0.3	—	—	—	1.33
	260R801	800:5	0.3	0.3	—	—	—	1.33
	260R122	1200:5	0.3	0.3	—	—	—	1.33
	260R162	1600:5	0.3	0.3	—	—	—	1.33
	260R202	2000:5	0.3	0.3	—	—	—	1.33
	260R252	2500:5	0.3	0.3	—	—	—	1.0
	260R302	3000:5	0.3	0.3	—	—	—	1.0
260R402	4000:5	0.3	0.3	—	—	—	1.0	
3-3/4 x 7-7/16	560R401	400:5	1.2	1.2	2.4	—	—	1.33
	560R501	500:5	0.6	1.2	2.4	—	—	1.33
	560R601	600:5	0.6	0.6	1.2	2.4	2.4	1.33
	560R751	750:5	0.6	0.6	1.2	1.2	2.4	1.33
	560R801	800:5	0.6	0.6	1.2	1.2	2.4	1.33
	560R102	1000:5	0.3	0.3	0.6	1.2	1.2	1.33
	560R122	1200:5	0.3	0.3	0.6	0.6	1.2	1.33
	560R152	1500:5	0.3	0.3	0.3	0.6	0.6	1.33
	560R162	1600:5	0.3	0.3	0.3	0.6	0.6	1.33
	560R202	2000:5	0.3	0.3	0.3	0.6	0.6	1.33
	560R252	2500:5	0.3	0.3	0.3	0.3	0.6	1.33
	560R302	3000:5	0.3	0.3	0.3	0.3	0.6	1.33
560R322	3200:5	0.3	0.3	0.3	0.3	0.6	1.33	
560R402	4000:5	0.3	0.3	0.3	0.3	0.6	1.33	
560R502	5000:5	0.3	0.3	0.3	0.3	0.6	1.33	

**Split-Core Current Transformers**

**Table 6.28: Split-Core Transformers, Model 270R is UR/cUR Recognized, 60 Hz**

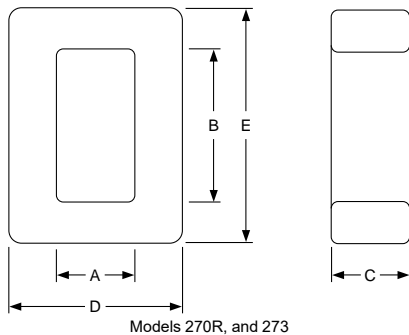

Models 270R, and 273

**Table 6.27: Dimensions for Models 270R, and 273**

Model	Dimensions (inches)				
	A	B	C	D	E
270R	3.56	8.81	3.00	9.25	13.06
273	3.50	6.25	3.27	9.25	11.28

Window Size (inches)	Catalog Number (without brackets) [10]	Current Rating (Amperes)	ANSI Accuracy Classification — 60 Hz Metering Class					Rating Factor 30 °C Ambient
			B-0.1	B-0.2	B-0.5	B-0.9	B-1.8	
3-9/16 x 8-3/16	270R401	400:5	—	—	—	—	—	1.33
	270R501	500:5	—	—	—	—	—	1.33
	270R601	600:5	—	—	—	—	—	1.33
3-9/16 x 8-3/16	270R801	800:5	1.2	2.4	—	—	—	1.33
	270R102	1000:5	1.2	1.2	2.4	—	—	1.33
	270R122	1200:5	1.2	1.2	2.4	—	—	1.33
	270R152	1500:5	1.2	1.2	2.4	—	—	1.33
	270R162	1600:5	1.2	1.2	2.4	—	—	1.33
	270R202	2000:5	1.2	1.2	1.2	2.4	—	1.33
	270R252	2500:5	1.2	1.2	1.2	2.4	—	1.33
	270R302	3000:5	1.2	1.2	1.2	1.2	2.4	1.0
	270R402	4000:5	1.2	1.2	1.2	1.2	1.2	1.0
270R502	5000:5	1.2	1.2	1.2	1.2	1.2	1.0	
3-1/2 x 6-1/4	273201	200:5	—	—	—	—	—	1.33
	273251	250:5	—	—	—	—	—	1.33
	273301	300:5	2.4	—	—	—	—	1.33
	273401	400:5	2.4	—	—	—	—	1.33
	273501	500:5	2.4	—	—	—	—	1.33
	273601	600:5	2.4	2.4	—	—	—	1.33
	273801	800:5	1.2	2.4	—	—	—	1.33
	273102	1000:5	1.2	1.2	2.4	—	—	1.33
	273122	1200:5	1.2	1.2	2.4	—	—	1.33
	273162	1600:5	1.2	1.2	2.4	—	—	1.33
	273202	2000:5	1.2	1.2	1.2	2.4	—	1.33
	273252	2500:5	1.2	1.2	1.2	2.4	—	1.33
273302	3000:5	1.2	1.2	1.2	1.2	2.4	1.00	
273402	4000:5	1.2	1.2	1.2	1.2	1.2	1.00	

[10] For mounting brackets, refer to [Bushing Current Transformers 50–400 Hz](#), page 6-14

Bushing Current Transformers 50–400 Hz

Table 6.31: Bushing Current Transformers

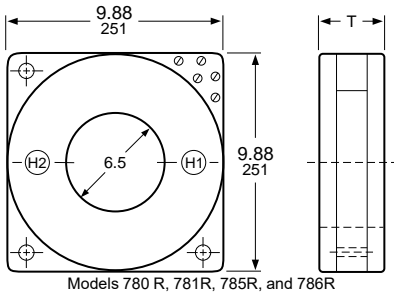

Models 780 R, 781R, 785R, and 786R

Table 6.29: Dimensions for Models 780R, 781R, 785R, and 786R

Model	T (inches)
780R	3.38
781R	3.38
785R	6.75
786R	6.75

Table 6.30: Mounting Brackets

Model	Bracket
2NR	MB1
5NR	MB1
7RL	MB7
54R	Included
64R	MB10
66R	MB12
74R	MB16
76R	MB18
81X	MB81
100R	MB31
110R	MB32
120R	MB31
140R	MB32
151R	MB30
152R	MB30
170R	MB30
180R	MB9
200R	Included
201R	Included
202R	Included
203R	Included
210R	MB32
260R	Not Available
270R	Not Available
273	Not Available

Window Size (inches)	Catalog Number	Current Rating [1] (Amperes)	Relay Class	ANSI Accuracy Classification—60 Hz Metering Class					Rating Factor 30°C Ambient
				B-0.1	B-0.2	B-0.5	B-0.9	B-1.8	
6-1/2	780R500	50:5	—	—	—	—	—	—	2.0
	780R750	75:5	C10	1.2	2.4	—	—	—	2.0
	780R101	100:5	C10	2.4	2.4	—	—	—	2.0
	780R151	150:5	C20	0.6	1.2	—	—	—	2.0
	780R201	200:5	C20	0.6	1.2	2.4	—	—	2.0
	780R251	250:5	C20	0.6	0.6	1.2	2.4	—	2.0
	780R301	300:5	C50	0.3	0.6	1.2	1.2	2.4	2.0
	780R401	400:5	C50	0.3	0.3	0.6	1.2	1.2	2.0
	780R501	500:5	C50	0.3	0.3	0.6	0.6	1.2	2.0
	780R601	600:5	C100	0.3	0.3	0.3	0.6	0.6	2.0
	780R751	750:5	C100	0.3	0.3	0.3	0.3	0.6	2.0
	780R801	800:5	C100	0.3	0.3	0.3	0.3	0.6	2.0
	780R102	1000:5	C100	0.3	0.3	0.3	0.3	0.3	2.0
	780R122	1200:5	C200	0.3	0.3	0.3	0.3	0.3	2.0
	780R152	1500:5	C200	0.3	0.3	0.3	0.3	0.3	2.0
	780R162	1600:5	C200	0.3	0.3	0.3	0.3	0.3	2.0
	780R202	2000:5	C200	0.3	0.3	0.3	0.3	0.3	2.0
	780R252	2500:5	C200	0.3	0.3	0.3	0.3	0.3	2.0
	780R302	3000:5	C200	0.3	0.3	0.3	0.3	0.3	2.0
	780R402	4000:5	C200	0.3	0.3	0.3	0.3	0.3	1.5
6-1/2	781R601	600:5 MR	C100	0.3	0.3	0.3	0.6	0.6	2.0
	781R122	1200:5 MR	C200	0.3	0.3	0.3	0.3	0.3	2.0
	781R202	2000:5 MR	C200	0.3	0.3	0.3	0.3	0.3	2.0
	781R302	3000:5 MR	C200	0.3	0.3	0.3	0.3	0.3	2.0
	781R402	4000:5 MR	C200	0.3	0.3	0.3	0.3	0.3	1.5
	785R500	50:5	C10	2.4	2.4	—	—	—	2.0
	785R750	75:5	C20	1.2	1.2	—	—	—	2.0
	785R101	100:5	C20	1.2	1.2	2.4	—	—	2.0
	785R151	150:5	C50	0.6	0.6	1.2	2.4	—	2.0
	785R201	200:5	C50	0.6	0.6	1.2	2.4	2.4	2.0
6-1/2	785R251	250:5	C50	0.3	0.6	1.2	1.2	2.4	2.0
	785R301	300:5	C100	0.3	0.3	0.6	0.6	1.2	2.0
	785R401	400:5	C100	0.3	0.3	0.3	0.6	1.2	2.0
	785R501	500:5	C100	0.3	0.3	0.3	0.6	0.6	2.0
	785R601	600:5	C200	0.3	0.3	0.3	0.3	0.6	2.0
	785R751	750:5	C200	0.3	0.3	0.3	0.3	0.3	2.0
	785R801	800:5	C200	0.3	0.3	0.3	0.3	0.3	2.0
	785R102	1000:5	C200	0.3	0.3	0.3	0.3	0.3	2.0
	785R122	1200:5	C400	0.3	0.3	0.3	0.3	0.3	2.0
	785R152	1500:5	C400	0.3	0.3	0.3	0.3	0.3	2.0
6-1/2	785R162	1600:5	C400	0.3	0.3	0.3	0.3	0.3	2.0
	785R202	2000:5	C400	0.3	0.3	0.3	0.3	0.3	2.0
	785R252	2500:5	C400	0.3	0.3	0.3	0.3	0.3	2.0
	785R302	3000:5	C400	0.3	0.3	0.3	0.3	0.3	2.0
	785R402	4000:5	C400	0.3	0.3	0.3	0.3	0.3	1.5
	786R601	600:5 MR	C200	0.3	0.3	0.3	0.3	0.3	2.0
	786R122	1200:5 MR	C400	0.3	0.3	0.3	0.3	0.3	2.0
	786R202	2000:5 MR	C400	0.3	0.3	0.3	0.3	0.3	2.0
	786R302	3000:5 MR	C400	0.3	0.3	0.3	0.3	0.3	2.0
	786R402	4000:5 MR	C400	0.3	0.3	0.3	0.3	0.3	1.5

Auxiliary Current Transformers

Table 6.32: Auxiliary Current Transformers

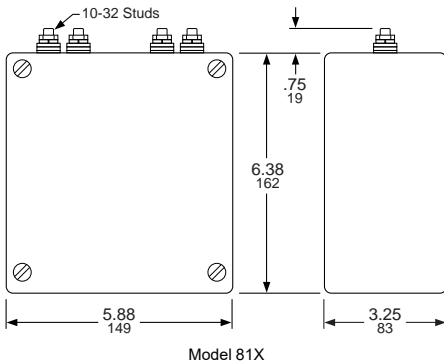

Model 81X

Catalog Number (without brackets)	Ratio
81X05000100	5:1
81X05000200	5:2
81X05000250	5:2.5
81X05000500	5:5
81X07500500	7.5:5
81X10000500	10:5
81X12500500	12.5:5
81X15000500	15:5

NOTE: Model 81X Accuracy 0.3B0.1, B0.2, B0.5@60 Hz, RF=1.5@30 °C

[1] For multi-ratio (MR) taps, refer to Table 6.24 Multi-Ratio Taps (Models 151R, 312R, 781R, 786R), page 6-12

**Obsolete—January 1, 2016**  
**Energy Efficient Three-Phase**

NOTE: International products—for export use only.

**Table 6.33: EE Three Phase; 60HZ; 208Y/120 Secondary; cULus Listed**

kVA	Catalog No.	Minimum Efficiency @ 35% 75° C	Full Capacity Taps	Degree C Temp. Rise	Insulation Class	%IZ	Sound Level dB	Weight (lbs)	Enclosure
<b>480 V Delta Primary, Aluminum Windings</b>									
15	EE15T3H	97.0%	6-2.5%2+4-	150	220	5.1%	45	220	17D
30	EE30T3H	97.5%	6-2.5%2+4-	150	220	5.5%	45	260	17D
45	EE45T3H	97.7%	6-2.5%2+4-	150	220	6.0%	45	368	18D
75	EE75T3H	98.0%	6-2.5%2+4-	150	220	3.7%	50	585	20D
112.5	EE112T3H	98.2%	6-2.5%2+4-	150	220	5.2%	50	620	21D
150	EE150T3H	98.3%	6-2.5%2+4-	150	220	6.0%	50	835	22D
225	EE225T3H	98.5%	6-2.5%2+4-	150	220	6.5%	55	1110	24D
300	EE300T3H	98.6%	6-2.5%2+4-	150	220	5.9%	55	1350	25D
500	EE500T68H	98.7%	4-2.5%2+2-	150	220	6.1%	60	1875	30D
750	EE750T68H	98.8%	4-2.5%2+2-	150	220	5.4%	64	2965	31D
1000	EE1000T77H	98.9%	2-5%1+1-	150	220	5.7%	64	5200	33F
<b>600 V Delta Primary, Aluminum Windings</b>									
15	EE15T65H	97.0%	6-2.5%2+4-	150	220	4.5%	45	240	17D
30	EE30T65H	97.5%	6-2.5%2+4-	150	220	5.9%	45	290	17D
45	EE45T65H	97.7%	6-2.5%2+4-	150	220	6.4%	45	372	18D
75	EE75T65H	98.0%	6-2.5%2+4-	150	220	3.6%	50	585	20D
112.5	EE112T65H	98.2%	6-2.5%2+4-	150	220	5.0%	50	712	21D
150	EE150T65H	98.3%	6-2.5%2+4-	150	220	3.7%	50	790	22D
225	EE225T65H	98.5%	6-2.5%2+4-	150	220	5.1%	55	945	24D
300	EE300T65H	98.6%	6-2.5%2+4-	150	220	5.6%	55	1305	25D
500	EE500T79H	98.7%	4-2.5%2+2-	150	220	6.0%	60	1870	30D
750	EE750T79H	98.8%	4-2.5%2+2-	150	220	5.4%	64	2990	31D
1000	EE1000T79H	98.9%	4-2.5%2+2-	150	220	—	64	5800	33F
<b>208 V Delta Primary, Aluminum Windings</b>									
15	EE15T211H	97.0%	3-5%1+2-	150	220	5.1%	45	210	17D
30	EE30T211H	97.5%	3-5%1+2-	150	220	6.1%	45	210	17D
45	EE45T211H	97.7%	3-5%1+2-	150	220	5.7%	45	374	18D
75	EE75T211H	98.0%	3-5%1+2-	150	220	3.8%	50	575	20D
112.5	EE112T211H	98.2%	3-5%1+2-	150	220	5.3%	50	604	21D
150	EE150T211H	98.3%	3-5%1+2-	150	220	3.6%	50	795	22D
225	EE225T211H	98.5%	3-5%1+2-	150	220	4.9%	55	1000	24D
300	EE300T211H	98.6%	3-5%1+2-	150	220	5.2%	55	1425	25D
500	EE500T211H	98.7%	3-5%1+2-	150	220	6.2%	60	1870	30D
<b>240 V Delta Primary, Aluminum Windings</b>									
15	EE15T67H	97.0%	6-2.5%2+4-	150	220	4.1%	45	240	17D
30	EE30T67H	97.5%	6-2.5%2+4-	150	220	6.2%	45	260	17D
45	EE45T67H	97.7%	6-2.5%2+4-	150	220	5.7%	45	379	18D
75	EE75T67H	98.0%	6-2.5%2+4-	150	220	4.2%	50	590	20D
112.5	EE112T67H	98.2%	6-2.5%2+4-	150	220	6.0%	50	620	21D
150	EE150T67H	98.3%	6-2.5%2+4-	150	220	3.3%	50	805	22D
225	EE225T67H	98.5%	6-2.5%2+4-	150	220	5.2%	55	972	24D
300	EE300T239H	98.6%	3-5%1+2-	150	220	5.4%	55	1360	25D
500	EE500T239H	98.7%	3-5%1+2-	150	220	6.3%	60	1900	25D
<b>480 V Delta Primary, Copper Windings</b>									
15	EE15T3HCU	97.0%	6-2.5%2+4-	150	220	4.6%	45	310	17D
30	EE30T3HCU	97.5%	6-2.5%2+4-	150	220	4.6%	45	340	17D
45	EE45T3HCU	97.7%	6-2.5%2+4-	150	220	4.4%	45	418	18D
75	EE75T3HCU	98.0%	6-2.5%2+4-	150	220	3.5%	50	642	20D
112.5	EE112T3HCU	98.2%	6-2.5%2+4-	150	220	3.9%	50	725	21D
150	EE150T3HCU	98.3%	6-2.5%2+4-	150	220	4.7%	50	915	22D
225	EE225T3HCU	98.5%	6-2.5%2+4-	150	220	3.8%	55	1125	24D
300	EE300T3HCU	98.6%	6-2.5%2+4-	150	220	4.8%	55	1535	25D
500	EE500T68HCU	98.7%	4-2.5%2+2-	150	220	4.1%	60	2350	30D
750	EE750T68HCU	98.8%	4-2.5%2+2-	150	220	4.7%	—	3485	31D

**Table 6.34: EE Three Phase; 60HZ; 480Y/277 Secondary; cULus Listed**

kVA	Catalog No.	Minimum Efficiency @ 35% 75° C	Full Capacity Taps	Degree C Temp. Rise	Insulation Class	%IZ	Sound Level dB	Weight (lbs)	Enclosure	H	W	D
<b>208 V Delta Primary, Aluminum Windings</b>												
15	EE15T212H	97.0%	3-5%1+2-	150	220	4.2%	45	220	17D	27.00 / 686	20.00 / 508	16.00 / 406
30	EE30T212H	97.5%	3-5%1+2-	150	220	6.5%	45	260	17D	27.00 / 686	20.00 / 508	16.00 / 406
45	EE45T212H	97.7%	3-5%1+2-	150	220	6.0%	45	368	18D	30.00 / 762	20.00 / 508	20.00 / 508
75	EE75T212H	98.0%	3-5%1+2-	150	220	6.9%	50	585	20D	37.00 / 940	30.00 / 762	20.00 / 508
112.5	EE112T212H	98.2%	3-5%1+2-	150	220	5.4%	50	620	21D	37.00 / 940	30.00 / 762	24.00 / 610
150	EE150T212H	98.3%	3-5%1+2-	150	220	6.4%	50	835	22D	43.75 / 1111	32.00 / 813	27.00 / 686
225	EE225T212H	98.5%	3-5%1+2-	150	220	4.7%	55	1110	24D	49.5 / 1257	35 / 889	28.5 / 724
300	EE300T212H	98.6%	3-5%1+2-	150	220	5.1%	55	1350	25D	49.5 / 1257	41 / 1041	32 / 813
500	EE500T212H	98.7%	3-5%1+2-	150	220	6.5%	60	1875	30D	71 / 1803	48 / 1219	36 / 914
<b>480 V Delta Primary, Aluminum Windings</b>												
15	EE15T1814H	97.0%	6-2.5%2+4-	150	220	4.8%	45	240	17D	27.00 / 686	20.00 / 508	16.00 / 406
30	EE30T1814H	97.5%	6-2.5%2+4-	150	220	4.7%	45	290	17D	27.00 / 686	20.00 / 508	16.00 / 406
45	EE45T1814H	97.7%	6-2.5%2+4-	150	220	5.7%	45	372	18D	30.00 / 762	20.00 / 508	20.00 / 508
75	EE75T1814H	98.0%	6-2.5%2+4-	150	220	4.5%	50	585	20D	37.00 / 940	30.00 / 762	20.00 / 508
112.5	EE112T1814H	98.2%	6-2.5%2+4-	150	220	5.1%	50	712	21D	37.00 / 940	30.00 / 762	24.00 / 610
150	EE150T1814H	98.3%	6-2.5%2+4-	150	220	3.3%	50	790	22D	43.75 / 1111	32.00 / 813	27.00 / 686
225	EE225T1814H	98.5%	6-2.5%2+4-	150	220	4.0%	55	945	24D	49.5 / 1257	35 / 889	28.5 / 724
300	EE300T1814H	98.6%	6-2.5%2+4-	150	220	4.9%	55	1305	25D	49.5 / 1257	41 / 1041	32 / 813
500	EE500T76H	98.7%	4-2.5%2+2-	150	220	5.8%	60	1870	30D	71 / 1803	48 / 1219	36 / 914

TRANSFORMERS 6

Obsolete—January 1, 2016

Table 6.35: EE Three Phase; 60HZ; 240 Delta Secondary; cULus Listed

kVA	Catalog No.	Minimum Efficiency @ 35% 75° C	Full Capacity Taps	Degree C Temp. Rise	Insulation Class	%Z	Sound Level dB	Weight (lbs)	Enclosure
<b>480 V Delta Primary, Aluminum Windings</b>									
15	EE15T6H	97.0%	6-2.5%2+4-	150	220	4.1%	45	220	17D
30	EE30T6H	97.5%	6-2.5%2+4-	150	220	5.6%	45	260	17D
45	EE45T6H	97.7%	6-2.5%2+4-	150	220	6.1%	45	368	18D
75	EE75T6H	98.0%	6-2.5%2+4-	150	220	3.9%	50	585	20D
112.5	EE112T6H	98.2%	6-2.5%2+4-	150	220	5.4%	50	620	21D
150	EE150T6H	98.3%	6-2.5%2+4-	150	220	3.9%	50	835	22D
225	EE225T6H	98.5%	6-2.5%2+4-	150	220	4.4%	55	1110	24D
300	EE300T6H	98.6%	6-2.5%2+4-	150	220	5.3%	55	1350	25D
500	EE500T63H	98.7%	4-2.5%2+2-	150	220	5.7%	60	1875	30D
750	EE750T63H	98.8%	4-2.5%2+2-	150	220	5.2%	64	2965	31D
1000	EE1000T78H	98.9%	2-5%1+1-	150	220	5.3%	64	5200	33F
<b>480 V Delta Primary, Aluminum Windings</b>									
240 Delta with 120 center taps have historically been limited to 5% capacity on the center tap. The new units from Schneider Electric offer greater limits on 120 V center tap. Limits are determined by the total transformer loading and the following formula used to size new 120 V center tap units: (240 V balanced loads) + 2.5 x (120 V loads) = kVA required									
15	EE15T151HCT	97.0%	2-5%-	150	220	5.3%	45	220	17D
30	EE30T151HCT	97.5%	2-5%-	150	220	5.6%	45	295	17D
45	EE45T151HCT	97.7%	2-5%-	150	220	5.7%	45	385	18D
75	EE75T151HCT	98.0%	2-5%-	150	220	4.7%	50	590	19D
112.5	EE112T151HCT	98.2%	2-5%-	150	220	4.3%	50	635	21D
150	EE150T151HCT	98.3%	2-5%-	150	220	3.1%	50	783	22D
225	EE225T151HCT	98.5%	2-5%-	150	220	3.8%	55	1080	24D
300	EE300T151HCT	98.6%	2-5%-	150	220	4.6%	55	1355	25D
500	EE500T151HCT	98.7%	2-5%-	150	220	5.1%	60	2137	30D
750	EE750T151HCT	98.8%	2-5%-	150	220	5.6%	64	2982	31D
1000	EE1000T151HCT	98.9%	2-5%-	150	220	—	64	5800	33F

Obsolete—January 1, 2016

EE Watchdog Transformers

NOTE: International products—for export use only.

Table 6.36: EE Three Phase Watchdog Transformers: 60HZ, cULus Listed

kVA	Catalog No.	Minimum Efficiency @ 35% 75° C	Full Capacity Taps	Degree C Temp. Rise	Insulation Class	%Z	Sound Level dB	Weight (lbs)	Enclosure
<b>480 V Delta Primary, 208Y/120 Secondary, Aluminum Windings</b>									
15	EE15T3HF	97.0%	6-2.5%2+4-	115	220	5.3%	45	220	17D
30	EE30T3HF	97.5%	6-2.5%2+4-	115	220	5.3%	45	368	18D
45	EE45T3HF	97.7%	6-2.5%2+4-	115	220	5.2%	45	585	20D
75	EE75T3HF	98.0%	6-2.5%2+4-	115	220	6.3%	50	620	21D
112.5	EE112T3HF	98.2%	6-2.5%2+4-	115	220	5.3%	50	835	22D
150	EE150T3HF	98.3%	6-2.5%2+4-	115	220	5.1%	50	980	24D
225	EE225T3HF	98.5%	6-2.5%2+4-	115	220	6.0%	55	1349	25D
300	EE300T68HF	98.6%	4-2.5%2+2-	115	220	3.7%	55	2050	30D
500	EE500T68HF	98.7%	4-2.5%2+2-	115	220	6.6%	60	2330	30D
<b>480 V Delta Primary, 208Y/120 Secondary, Copper Windings</b>									
15	EE15T3HFCU	97.0%	6-2.5%2+4-	115	220	5.0%	45	260	17D
30	EE30T3HFCU	97.5%	6-2.5%2+4-	115	220	2.8%	45	420	18D
45	EE45T3HFCU	97.7%	6-2.5%2+4-	115	220	2.0%	45	642	20D
75	EE75T3HFCU	98.0%	6-2.5%2+4-	115	220	3.4%	50	675	21D
112.5	EE112T3HFCU	98.2%	6-2.5%2+4-	115	220	3.7%	50	471	22D
150	EE150T3HFCU	98.3%	6-2.5%2+4-	115	220	2.5%	50	1050	24D
225	EE225T3HFCU	98.5%	6-2.5%2+4-	115	220	3.8%	55	1220	25D
300	EE300T68HFCU	98.6%	4-2.5%2+2-	115	220	4.8%	55	2300	30D
500	EE500T68HFCU	98.7%	4-2.5%2+2-	115	220	4.1%	60	2409	30D
<b>480 V Delta Primary, 208Y/120 Secondary, Aluminum Windings</b>									
15	EE15T3HB	97.0%	6-2.5%2+4-	80	220	5.1%	45	220	17D
30	EE30T3HB	97.5%	6-2.5%2+4-	80	220	3.7%	45	368	18D
45	EE45T3HB	97.7%	6-2.5%2+4-	80	220	2.1%	45	585	20D
75	EE75T3HB	98.0%	6-2.5%2+4-	80	220	3.3%	50	620	21D
112.5	EE112T3HB	98.2%	6-2.5%2+4-	80	220	3.7%	50	835	22D
150	EE150T3HB	98.3%	6-2.5%2+4-	80	220	3.1%	50	980	24D
225	EE225T3HB	98.5%	6-2.5%2+4-	80	220	4.2%	55	1349	25D
300	EE300T68HB	98.6%	4-2.5%2+2-	80	220	4.8%	55	2400	30D
500	EE500T68HB	98.7%	4-2.5%2+2-	80	220	3.6%	60	2964	30D
<b>480 V Delta Primary, 208Y/120 Secondary, Copper Windings</b>									
15	EE15T3HBCU	97.0%	6-2.5%2+4-	80	220	4.7%	45	260	17D
30	EE30T3HBCU	97.5%	6-2.5%2+4-	80	220	2.7%	45	418	18D
45	EE45T3HBCU	97.7%	6-2.5%2+4-	80	220	1.8%	45	642	20D
75	EE75T3HBCU	98.0%	6-2.5%2+4-	80	220	2.5%	50	725	21D
112.5	EE112T3HBCU	98.2%	6-2.5%2+4-	80	220	2.2%	50	910	22D
150	EE150T3HBCU	98.3%	6-2.5%2+4-	80	220	2.3%	50	1125	24D
225	EE225T3HBCU	98.5%	6-2.5%2+4-	80	220	3.6%	55	1425	25D
300	EE300T68HBCU	98.6%	4-2.5%2+2-	80	220	4.3%	55	2400	30D
500	EE500T68HBCU	98.7%	4-2.5%2+2-	80	220	5.0%	60	2578	30D

6 TRANSFORMERS



**Obsolete—January 1, 2016**  
**EE NL and NLP Series Transformers**

- International products—for export use only.
- Three-phase dry type transformers, 480 Delta to 208Y/120
- Aluminum or copper windings
- Electrostatic shield
- Class 220 insulation
- Double size neutral terminal for additional customer neutral cables
- Additional coil capacity to compensate for higher non-linear load loss
- cULus Listed

**Table 6.37: EE Three Phase; 60HZ; 480 V Delta Primary, 208Y/120 Secondary; cULus Listed**

kVA	Catalog No.	Minimum Efficiency @ 35% 75° C	Full Capacity Taps	Degree C Temp. Rise	Insulation Class	%IZ	Sound Level dB	Weight (lbs)	Enclosure
<b>NL Series for Typical Non-Linear Load Services, K-4 Rated, Aluminum Windings</b>									
15	EE15T3HFISNL	97.0%	6-2.5%2+4-	115	220	4.0%	45	256	17D
30	EE30T3HFISNL	97.5%	6-2.5%2+4-	115	220	4.6%	45	320	18D
45	EE45T3HFISNL	97.7%	6-2.5%2+4-	115	220	3.3%	45	515	20D
75	EE75T3HFISNL	98.0%	6-2.5%2+4-	115	220	4.4%	50	535	21D
112.5	EE112T3HFISNL	98.2%	6-2.5%2+4-	115	220	5.2%	50	800	22D
150	EE150T3HFISNL	98.3%	6-2.5%2+4-	115	220	3.4%	50	1110	24D
225	EE225T3HFISNL	98.5%	6-2.5%2+4-	115	220	4.4%	55	1349	25D
300	EE300T68HFISNL	98.6%	6-2.5%2+4-	115	220	4.8%	55	1750	30D
500	EE500T68HFISNL	98.7%	4-2.5%2+2-	115	220	4.2%	60	2295	31D
<b>NL Series for Typical Non-Linear Load Services, K-4 Rated, Copper Windings</b>									
15	EE15T3HFISCUNL	97.0%	6-2.5%2+4-	115	220	4.7%	45	260	17D
30	EE30T3HFISCUNL	97.5%	6-2.5%2+4-	115	220	3.4%	45	395	18D
45	EE45T3HFISCUNL	97.7%	6-2.5%2+4-	115	220	5.2%	45	730	20D
75	EE75T3HFISCUNL	98.0%	6-2.5%2+4-	115	220	6.5%	50	640	20D
112.5	EE112T3HFISCUNL	98.2%	6-2.5%2+4-	115	220	3.8%	50	935	22D
150	EE150T3HFISCUNL	98.3%	6-2.5%2+4-	115	220	4.6%	50	1300	24D
225	EE225T3HFISCUNL	98.5%	6-2.5%2+4-	115	220	3.6%	55	1450	24D
300	EE300T68HFISCUNL	98.6%	6-2.5%2+4-	115	220	4.7%	55	2450	25D
500	EE500T68HFISCUNL	98.7%	4-2.5%2+2-	115	220	5.0%	60	—	31D
<b>NLP Series for Typical Non-Linear Load Services, K-13 Rated, Aluminum Windings</b>									
15	EE15T3HFISNLP	97.0%	6-2.5%2+4-	115	220	4.0%	45	256	17D
30	EE30T3HFISNLP	97.5%	6-2.5%2+4-	115	220	4.6%	45	375	18D
45	EE45T3HFISNLP	97.7%	6-2.5%2+4-	115	220	3.3%	45	500	20D
75	EE75T3HFISNLP	98.0%	6-2.5%2+4-	115	220	3.3%	50	560	21D
112.5	EE112T3HFISNLP	98.2%	6-2.5%2+4-	115	220	4.7%	50	800	22D
150	EE150T3HFISNLP	98.3%	6-2.5%2+4-	115	220	3.4%	50	1110	24D
225	EE225T3HFISNLP	98.5%	6-2.5%2+4-	115	220	4.4%	55	1335	25D
300	EE300T68HFISNLP	98.6%	6-2.5%2+4-	115	220	4.4%	55	2350	30D
500	EE500T68HFISNLP	98.7%	4-2.5%2+2-	115	220	5.0%	60	3200	31D
<b>NLP Series for Typical Non-Linear Load Services, K-13 Rated, Copper Windings</b>									
15	EE15T3HFISCUNLP	97.0%	6-2.5%2+4-	115	220	3.8%	45	260	17D
30	EE30T3HFISCUNLP	97.5%	6-2.5%2+4-	115	220	3.4%	45	430	18D
45	EE45T3HFISCUNLP	97.7%	6-2.5%2+4-	115	220	4.5%	45	730	20D
75	EE75T3HFISCUNLP	98.0%	6-2.5%2+4-	115	220	6.5%	50	640	20D
112.5	EE112T3HFISCUNLP	98.2%	6-2.5%2+4-	115	220	3.7%	50	985	22D
150	EE150T3HFISCUNLP	98.3%	6-2.5%2+4-	115	220	4.4%	50	1135	24D
225	EE225T3HFISCUNLP	98.5%	6-2.5%2+4-	115	220	3.6%	55	1477	24D
300	EE300T68HFISCUNLP	98.6%	6-2.5%2+4-	115	220	3.5%	55	2650	30D
500	EE500T68HFISCUNLP	98.7%	4-2.5%2+2-	115	220	5.5%	60	—	31D

Obsolete—January 1, 2016

NOTE: International products—for export use only.

Table 6.38: Harmonic Mitigating, 480 Primary to 208zz/120 Secondary—UL Listed

kVA	Catalog No.	Minimum Efficiency @ 35% 75° C	Full Capacity Taps	Degree C Temp. Rise	Insulation Class	%IZ	Sound Level dB	Weight (lbs)	Enclosure
<b>480 V Delta Primary to 208/120 V Secondary with a 0° Phase Shift, 130° Rise</b>									
15	HM15T208NCU	97.0%	6–2.5% 2+4–	130	200	4.5%	45	310	17D
30	HM30T208NCU	97.5%	6–2.5% 2+4–	130	200	4.5%	45	340	17D
45	HM45T208NCU	97.7%	6–2.5% 2+4–	130	200	6.8%	45	418	18D
75	HM75T208NCU	98.0%	6–2.5% 2+4–	130	200	4.0%	50	642	20D
112.5	HM112T208NCU	98.2%	6–2.5% 2+4–	130	200	4.4%	50	725	21D
150	HM150T208NCU	98.3%	6–2.5% 2+4–	130	200	3.1%	50	915	22D
225	HM225T208NCU	98.5%	6–2.5% 2+4–	130	200	6.4%	55	1125	24D
300	HM300T208NCU	98.6%	4–2.5% 2+2–	130	200	5.6%	55	1535	25D
<b>480 V Primary to 208/120 V Secondary with a +30° Phase Shift, 130° C Rise</b>									
15	HM15T255NCU	97.0%	3–5% 1+3–	130	200	3.9%	45	310	17D
30	HM30T255NCU	97.5%	3–5% 1+3–	130	200	4.5%	45	340	17D
45	HM45T255NCU	97.7%	3–5% 1+3–	130	200	6.6%	45	418	18D
75	HM75T255NCU	98.0%	3–5% 1+3–	130	200	4.7%	50	642	20D
112.5	HM112T255NCU	98.2%	3–5% 1+3–	130	200	5.2%	50	725	21D
150	HM150T255NCU	98.3%	3–5% 1+3–	130	200	5.2%	50	915	22D
225	HM225T255NCU	98.5%	3–5% 1+3–	130	200	6.4%	55	1125	24D
300	HM300T255NCU	98.6%	3–5% 1+3–	130	200	6.6%	55	1535	25D
<b>480 V Delta Primary to 208/120 V Secondary with a +15° Phase Shift, 130° C Rise</b>									
15	HM15T251NCU	97.0%	6–2.5% 2+4–	130	200	2.7%	45	310	17D
30	HM30T251NCU	97.5%	6–2.5% 2+4–	130	200	2.4%	45	340	17D
45	HM45T251NCU	97.7%	6–2.5% 2+4–	130	200	4.5%	45	418	18D
75	HM75T251NCU	98.0%	6–2.5% 2+4–	130	200	4.1%	50	642	20D
112.5	HM112T251NCU	98.2%	6–2.5% 2+4–	130	200	4.1%	50	725	21D
150	HM150T251NCU	98.3%	6–2.5% 2+4–	130	200	3.2%	50	915	22D
225	HM225T251NCU	98.5%	6–2.5% 2+4–	130	200	5.6%	55	1125	24D
300	HM300T251NCU	98.6%	4–2.5% 2+2–	130	200	4.9%	55	1535	25D
<b>480 V Delta Primary to 208/120 V Secondary with a -15° Phase Shift, 130° C Rise</b>									
15	HM15T259NCU	97.0%	6–2.5% 2+4–	130	200	2.7%	45	310	17D
30	HM30T259NCU	97.5%	6–2.5% 2+4–	130	200	2.4%	45	340	17D
45	HM45T259NCU	97.7%	6–2.5% 2+4–	130	200	4.8%	45	418	18D
75	HM75T259NCU	98.0%	6–2.5% 2+4–	130	200	4.1%	50	642	20D
112.5	HM112T259NCU	98.2%	6–2.5% 2+4–	130	200	4.1%	50	725	21D
150	HM150T259NCU	98.3%	6–2.5% 2+4–	130	200	3.2%	50	915	22D
225	HM225T259NCU	98.5%	6–2.5% 2+4–	130	200	5.6%	55	1125	24D
300	HM300T259NCU	98.6%	4–2.5% 2+2–	130	200	4.9%	55	1535	25D

Additional temperature rises are available; for part numbers, see the Schneider Electric Product Configurator.