

AL Ball and Cushion Flexible Fixture Hangers

UNILETS® for Use with Threaded Rigid Metal Conduit and IMC. Ball Joint Permits 20° Swing.

Applications

- Designed for suspension of HID, fluorescent and incandescent lighting fixtures.
- Functions as combination conduit outlet box and hanger.

Features

- Protects fixture against wind and vibration damage.
- Cushion type for added protection where lighting fixtures are subjected to vibration.
- Dual function—conduit outlet box and fixture hanger.
- Choice of ball or cushion type.
- Swivel joint construction—allows 20° swing from vertical.
- Cushion style, with conical spring, supports up to 120 lbs/54 kg.
- Cushion type has setscrew for locking fixture stem.
- Fixture and hanger stem can be wired at work bench.
- Connection block available for convenient wiring of fixture leads.

Standard Materials

- Malleable iron with steel cover

Standard Finishes

- Malleable iron parts: triple-coat—(1) zinc electroplate, (2) chromate, and (3) epoxy powder coat
- Steel parts: zinc electroplate

Certifications and Compliances

- UL Listed: E109438



ALA — Ball Hanger



ALC — Ball Hanger



ALL — Cushion Hanger



ALT — Cushion Hanger



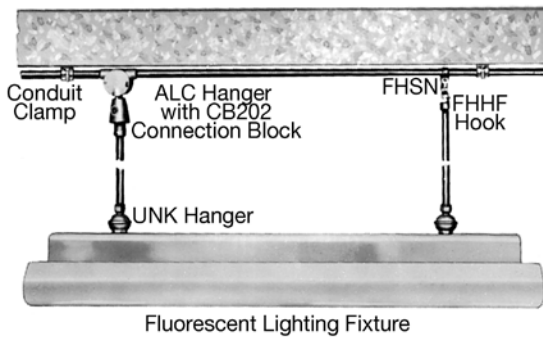

Illustrated Features



Lighting
LIGHTING: FLEXIBLE FIXTURE HANGERS — ORDINARY LOCATION

AL Ball and Cushion Flexible Fixture Hangers

UNILETS® for Use with Threaded Rigid Metal Conduit and IMC. Ball Joint Permits 20° Swing.

	Conduit Size (Inches)	Fixture Stem Size (Inches)	Support Weight (lbs/kg)	Catalog Number
ALA – Ball Hanger				
	1/2	1/2	250/112.5	ALA50-B
	3/4	1/2		ALA7550-B
	3/4	3/4	250/112.5	ALA75-B
ALA – Cushion Hanger – Furnished with a 3/4" to 1/2" reducer for 1/2" stems				
	1/2	3/4 or 1/2	3 to 12/1.4 to 5.4	ALA50-12
	3/4	3/4 or 1/2		ALA7575-12
	1/2	3/4 or 1/2	12 to 48/5.4 to 21.6	ALA50-48
	3/4	3/4 or 1/2		ALA7575-48
	1/2	3/4 or 1/2	48 to 120/21.6 to 54.0	ALA50-120
	3/4	3/4 or 1/2		ALA7575-120
ALC – Ball Hanger				
	1/2	1/2	250/112.5	ALC50-B
	3/4	1/2		ALC7550-B
	1	1/2		ALC1050-B
	3/4	3/4	250/112.5	ALC75-B
	1	3/4		ALC1075-B
ALC – Cushion Hanger – Furnished with a 3/4" to 1/2" reducer for 1/2" stems				
	1/2	3/4 or 1/2	3 to 12/1.4 to 5.4	ALC50-12
	3/4	3/4 or 1/2		ALC7575-12
	1	3/4 or 1/2		ALC1075-12
	1/2	3/4 or 1/2	12 to 48/5.4 to 21.6	ALC50-48
	3/4	3/4 or 1/2		ALC7575-48
	1	3/4 or 1/2		ALC1075-48
	1/2	3/4 or 1/2	48 to 120/21.6 to 54.0	ALC50-120
	3/4	3/4 or 1/2		ALC7575-120
	1	3/4 or 1/2		ALC1075-120

Lighting





LIGHTING: FLEXIBLE FIXTURE HANGERS – ORDINARY LOCATION

AL Ball and Cushion Flexible Fixture Hangers

UNILETS® for Use with Threaded Rigid Metal Conduit and IMC. Ball Joint Permits 20° Swing.







Lighting

LIGHTING: FLEXIBLE FIXTURE HANGERS — ORDINARY LOCATION

	Conduit Size (Inches)	Fixture Stem Size (Inches)	Support Weight (lbs/kg)	Catalog Number
ALL — Ball Hanger				
	1/2	1/2	250/112.5	ALL50-B
	3/4	1/2		ALL7550-B
	3/4	3/4	250/112.5	ALL75-B
ALL — Cushion Hanger — Furnished with a 3/4" to 1/2" reducer for 1/2" stems				
	1/2	3/4 or 1/2	3 to 12/1.4 to 5.4	ALL50-12
	3/4	3/4 or 1/2		ALL7575-12
	1/2	3/4 or 1/2	12 to 48/5.4 to 21.6	ALL50-48
	3/4	3/4 or 1/2		ALL7575-48
	1/2	3/4 or 1/2	48 to 120/21.6 to 54	ALL50-120
3/4	3/4 or 1/2	ALL7575-120		
ALT — Ball Hanger				
	1/2	1/2	250/112.5	ALT50-B
	3/4	1/2		ALT7550-B
	1	1/2		ALT1050-B
	3/4	3/4	250/112.5	ALT75-B
	1	3/4		ALT1075-B
ALT — Cushion Hanger — Furnished with a 3/4" to 1/2" reducer for 1/2" stems				
	1/2	3/4 or 1/2	3 to 12/1.4 to 5.4	ALT50-12
	3/4	3/4 or 1/2		ALT7575-12
	1	3/4 or 1/2		ALT1075-12
	1/2	3/4 or 1/2	12 to 48/5.4 to 21.6	ALT50-48
	3/4	3/4 or 1/2		ALT7575-48
	1	3/4 or 1/2		ALT1075-48
	1/2	3/4 or 1/2	48 to 120/21.6 to 54	ALT50-120
	3/4	3/4 or 1/2		ALT7575-120
	1	3/4 or 1/2		ALT1075-120

AL Flexible Fixture Hanger Parts and Dimensions

UNILETS® for Use with Threaded Rigid Metal Conduit and IMC.

	Size (Inches)	Support Weight (lbs/kg)	Catalog Number
AL — Hanger Bodies			
 ALA	1/2	<i>(Refer to Cushion and Ball Fixture Stems Below)</i>	ALA50
	3/4		ALA75
 ALC	1/2	<i>(Refer to Cushion and Ball Fixture Stems Below)</i>	ALC50
	3/4		ALC75
	1		ALC100
 ALL	1/2	<i>(Refer to Cushion and Ball Fixture Stems Below)</i>	ALL50
	3/4		ALL75
 ALT	1/2	<i>(Refer to Cushion and Ball Fixture Stems Below)</i>	ALT50
	3/4		ALT75
	1		ALT100
AL — Ball Fixture Stem			
	1/2	250/112.5	BJ50
	3/4		BJ75
AL — Cushion Fixture Stems			
Fixture stem tapped for 3/4"; 3/4" to 1/2" reducer furnished for 1/2" stems. With setscrew for locking fixture stem.			
	3/4 or 1/2	3-12 / 1.4-5.4	CJC75-12
	3/4 or 1/2	12-48 / 5.4-21.6	CJC75-48
	3/4 or 1/2	48-120 / 21.6-54.0	CJC75-120
AL — Porcelain Connection Block			
	2 Wire, 20 Amp, 277 Volt Maximum Wire Size Two No. 10 AWG Large Terminal Two No. 14 AWG Small Terminal		CB202

AL Fixture Hanger Dimensions

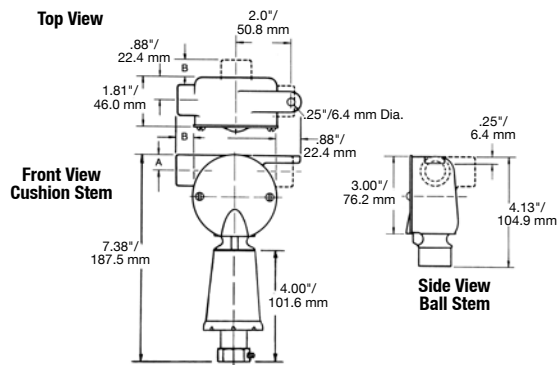

Conduit Trade Size	Dimensions in Inches/Millimeters	
	A	B
1/2"	0.56/4.2	0.69/17.5
3/4"	0.69/17.5	0.69/17.5
1"	0.88/22.4	0.81/20.6

Lighting
 LIGHTING: FLEXIBLE FIXTURE HANGERS — ORDINARY LOCATION