

Twist-Lock® Devices

50A, 250V DC, 600V AC, 3 Pole, 4 Wire Grounding

Insulgrip® Plug

HUBBELL

Features

- Super tough nylon housing offers better impact qualities
- Stainless steel shroud protects contacts and prevents mismatching
- Heavy duty two-piece external cord clamp provides maximum strain relief
- Box terminal with hex socket threaded slug, permits high clamping pressure on conductors without damaging strands
- Thermoplastic polyester interior provides heat resistance and impact strength



Ordering Information

Description	Cord Diameter	UPC	Catalog Number
Nylon cover, thermoplastic polyester interior	.830"-1.250" (21.08-31.75)	783585237855	HBL7765C

Listings

Listed to UL 498
Certified to CSA C22.2 No.42

Specifications

Housing	Nylon
Blade Holder	Polyester
Blades	Brass
Shell	Stainless Steel
Terminal Screws	Stainless steel
Cord Grip	Polyester

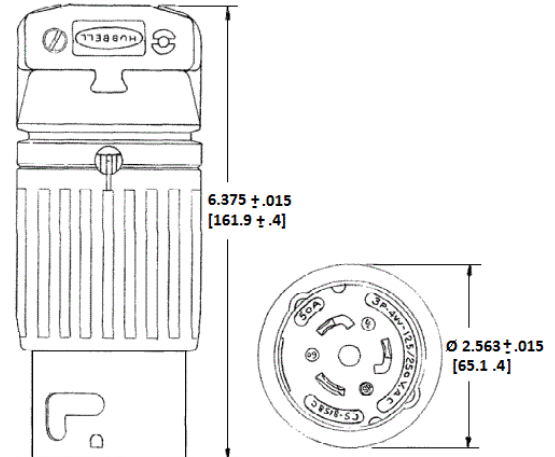

Performance

Electrical	
Current Interrupting	Certified for current interrupting at full rated current
Dielectric Voltage	Withstands 2,000V minimum

Mechanical	
Terminal Accommodation	#8 AWG - #4 AWG stranded copper wire only

Environmental	
Flammability	HB or better
Operating Temperatures	Maximum continuous 75°C; minimum -40°C (w/o impact)

Accessories

Connector	HBL7764C
Single Receptacle	HBL7379
Weatherproof Boot	HBL7716C

Online Resources

Customer Use Drawing
eCatalog
Installation Instructions

Dimensions in Inches (mm)

Hubbell Wiring Device-Kellems • Hubbell Incorporated (Delaware) • 40 Waterview Drive • Shelton, CT 06484

Phone (800) 288-6000 • Fax (800) 255-1031 • Specifications subject to change without notice.

