



Main

Range of product	Harmony 9001K Harmony 9001SK
Product or component type	Empty enclosure
Device short name	9001K
Number of cut-out	1 cut-out
Cable entry	1 entry tapped for 3/4" cable gland

Complementary

Product destination	For Ø 30 mm control and signalling units
Material	Aluminium
Net Weight	2.58 lb(US) (1.17 kg)

Environment

Protective treatment	TH
Ambient air temperature for storage	-40...158 °F (-40...70 °C)
Ambient air temperature for operation	-13...158 °F (-25...70 °C)
Overvoltage category	II IEC 61140
NEMA degree of protection	NEMA 1 NEMA 12 NEMA 13 NEMA 3 NEMA 4 NEMA 6

Ordering and shipping details

Category	21426 - 9001 K (NOT KA,KM,KX)
Discount Schedule	CS1
GTIN	00785901874423
Nbr. of units in pkg.	1
Package weight(Lbs)	2.6 lb(US) (1.18 kg)
Returnability	Yes
Country of origin	MX

Packing Units

Unit Type of Package 1	PCE
Package 1 Height	4.00 in (10.16 cm)
Package 1 width	4.20 in (10.668 cm)
Package 1 Length	4.50 in (11.43 cm)
Unit Type of Package 2	S03
Number of Units in Package 2	12
Package 2 Weight	32.97 lb(US) (14.957 kg)

Package 2 Height	11.81 in (30 cm)
Package 2 width	11.81 in (30 cm)
Package 2 Length	15.75 in (40 cm)
Unit Type of Package 3	PAL
Number of Units in Package 3	264
Package 3 Weight	705.00 lb(US) (319.782 kg)
Package 3 Height	40.00 in (101.6 cm)
Package 3 width	40.00 in (101.6 cm)
Package 3 Length	48.00 in (121.92 cm)

Offer Sustainability

Sustainable offer status	Green Premium product
California proposition 65	WARNING: This product can expose you to chemicals including: Nickel compounds, which is known to the State of California to cause cancer, and Di-isodecyl phthalate (DIDP), which is known to the State of California to cause birth defects or other reproductive harm. For more information go to www.P65Warnings.ca.gov
REACH Regulation	REACH Declaration
REACH free of SVHC	Yes
EU RoHS Directive	Pro-active compliance (Product out of EU RoHS legal scope) EU RoHS Declaration
Toxic heavy metal free	Yes
Mercury free	Yes
RoHS exemption information	Yes
China RoHS Regulation	China RoHS Declaration
Environmental Disclosure	Product Environmental Profile

Contractual warranty

Warranty	18 months
----------	-----------

Dimensions

Below drawing shows a 2-hole enclosure. Refer to the product characteristics to get the number of holes.

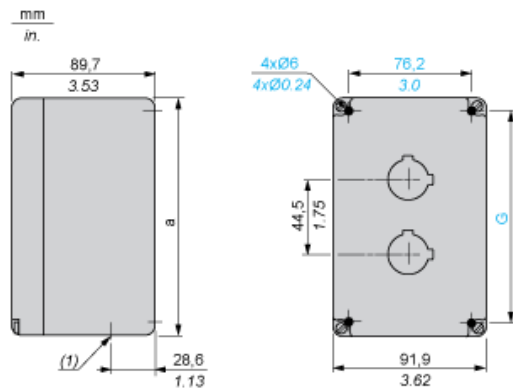

(1) Conduit thread: 9001 KY•: 3/4". 9001 TY•: 14 mm / 0.55 in.

a		G	
mm	in.	mm	in.
101.6	4.00	69.9	2.75