

NOTE: A newer document is available.

See [SD_100CT1902_SEC-11](#)

Visit [DigestPLUS](#) online for the most current **Digest content**

Section 11

Obsolescent and Obsolete Circuit Breakers

Obsolescent and Obsolete Types	11-2
Circuit Breaker Availability	11-2
Pictorial and Dimensions	11-4
Obsolescent Circuit Breakers	11-6
PowerPact™ D-Frame Circuit Breakers	11-6
Photovoltaic Circuit Breakers and Switches	11-7
F-Frame Thermal-Magnetic Circuit Breakers	11-11
K-Frame Thermal-Magnetic Circuit Breakers	11-12
L-Frame Thermal-Magnetic Circuit Breakers	11-13
L-Frame Micrologic™ Series B Trip Circuit Breakers	11-14
Mission Critical Circuit Breakers	11-17
500 Vdc Circuit Breakers	11-18
P-Frame Replacement Handles, Adapter Plate and Exchange Program	11-19
Automatic Molded-Case Switches	11-20
Mag-Gard™ Motor Circuit Protector	11-21
UL Listed Marine Circuit Breakers	11-23
Circuit Breakers for NQO, NQOB, NQOD and ML Panelboards	11-24
Rating Plugs For Obsolete Electronic Trip Circuit Breakers	11-25
EH/EHB Circuit Breakers	11-26
FJA Thermal-Magnetic Circuit Breakers	11-28
QE Metering Circuit Breakers	11-29
KD/KG Thermal-Magnetic Circuit Breakers	11-30
NHL Thermal-Magnetic Molded Case Circuit Breaker	11-31
Molded Case Circuit Breakers	11-32
M-Frame Thermal-Magnetic Circuit Breakers	11-32
Circuit Breaker Accessories	11-33
Circuit Breakers Electrical Accessories	11-33
PowerPact™ Circuit Breakers Miscellaneous Accessories	11-34
Neutral CTs and Micrologic™ Series B Trip Unit Accessories	11-36
Field-Installable Accessories	11-37
Electrical Operators and Handle Accessories	11-38
Lug Information	11-39
Electronic Products	11-42
Micrologic™ Series 2/3/A/B Trip Unit Test Sets	11-42
Ground-Fault Protection	11-43
Micrologic™ Add-On Ground-Fault Module (GFM)	11-43
Obsolescent Circuit Breakers	11-44
Masterpact™ M/MP/MC Circuit Breakers, UL 489/1066 Listed	11-44
Masterpact™ M/MP/MC Circuit Breaker Control Units	11-45
Masterpact™ M/MP/MC Circuit Breaker Accessories	11-46
Masterpact™ M/MP/MC Circuit Breaker Spare Parts	11-48
California Proposition 65	11-48

Circuit Breaker Availability

Table 11.1: Circuit Breaker Availability

Series of Cat. No.	Frame Size	Volts	Poles	Amperes	Availability	
					Obsolete No Longer Available	Obsolescent
115A-130A	MO-1 (Add-on)	120 Vac	1	15-30	X	
215A-250A	MO-2 (Add-on)	120/240 Vac	2	15-50	X	
215B-250B	MO-2B (Add-on)	120/240 Vac	2 S.P.	15-50	X	
70000	Multi-Breaker	120 Vac	4 S.P.	15-50	X	
111600	MO-2	120/240 Vac	2	15-30	X	
131600	MO-2	120/240 Vac	2	15-30	X	
151101	MO-1	120 Vac	1	15-30	X	
151600	MO-2	120/240 Vac	2	15-30	X	
161101	MO-1	120 Vac	1 With SN	15-30	X	
161600	MO-2	120/240 Vac	2 With SN	15-30	X	
161700	MO-2	120/240 Vac	2 S.P.	15-30	X	
260000	MB (Left-hand)	120 Vac	4 S.P.	15-50	X	
270000	MB (Right-hand)	120 Vac	4 S.P.	15-50	X	
460000	MO-8	120/240 Vac	4 S.P.	15-50	X	
470000	MO-4	120/240 Vac	4 S.P.	15-40	X	
480000	MO-4 (Plug-in)	120/240 Vac	4 S.P.	15-50	X	
940000	LM	600 Vac	2-3	125-800	X	
950000	50 A Form W	250 Vac	1, 2, 3	15-50	X	
951000	50 A Form W	250 Vac	2, 3	15-50	X	
952000	50 A Form W	250 Vac	2, 3	15-50	X	
953000	Flip-on Form W	230 Vac	1, 2, 3	15-50	X	
954000	100 A Form W (Trip Unit)	250 Vac	2, 3	50-100	X	
955000	100 A Form W	250 Vac	2, 3	50-100	X	
956000	225 A Form W	250 Vac	2, 3	70-225	X	
957000	400 A (KL) Form W	250 Vac	2, 3	125-400	X	
958000	600 A (WL) Form W	250 Vac	2, 3	225-600	X	
959000	KL Frame Only	600 Vac	2, 3	125-400	X	
961000	50 A Form W	600 Vac	2, 3	15-50	X	
962000	50 A Form W	600 Vac	2, 3	15-50	X	
964000	100 A Form W	600 Vac	2, 3	50-100	X	
965000	100 A Form W	600 Vac	2, 3	50-100	X	
966000	225 A Form W	600 Vac	2, 3	70-225	X	
967000	400 A (KL) Form W	600 Vac	2, 3	125-400	X	
968000	600 A (WL) Form W	600 Vac	2, 3	225-600	X	
970000	Type L Form W	240 Vac	1, 2, 3	10-50	X	
971000	Type L Form W (Flip-on)	240 Vac	1, 2, 3	10-50	X	
972000	M1 (Bolt-on)	240 Vac	2, 3	15-70	X	
973000	M2 (Bolt-on)	240 Vac	2, 3	50-100	X	
974000	MM (M) (Bolt-on)	120/240 Vac	2 S.P.	15-50	X	
975000	100 A Trip Unit	250 Vac	2, 3	50-100	X	
976000	225 A Trip Unit	250 Vac	2, 3	70-225	X	
977000	KL Trip Unit	600 Vac	2, 3	125-400	X	
978000	LM Trip Unit	600 Vac	2, 3	225-800	X	
979000	WL Frame	600 Vac	2, 3	225-600	X	
982000	50 A Form W (Flip-on)	125/250 Vac	1, 2, 3	15-50	X	
984000	ML-2	250 Vac	2, 3	50-100	X	
985000	100 A (G) Form W	600 Vac	2, 3	50-100	X	
986000	100 A (F) Form W	600 Vac	2, 3	10-100	X	
987000	ML-3	250 Vac	2, 3	125-225	X	
988000	ML-1	250 Vac	2, 3	15-100	X	
989000	ML-1	480 Vac	2, 3	15-100	X	
991000	QB	120/240 Vac	1	15-50	X	
992000	ML	120/240 Vac	1, 2, 3	10-50	X	
992900	ML Form Y	277 Vac	1	10-20	X	
994000	ML-2	600 Vac	2, 3	15-100	X	
995000	100 A (G) Form W	600 Vac	2, 3	15-100	X	
996000	100 A (F) Form W	600 Vac	2, 3	15-100	X	
997000	ML-3	600 Vac	2, 3	50-225	X	
998000	ML-1	600 Vac	2, 3	15-100	X	
999000	ML-1	600 Vac	2, 3	15-100	X	
A1B	100 A	120/240 Vac	1, 2, 3	15-100	X	
PowerPact D-Frame	600 A	600 Vac	3, 4	150-600	X	See page 11-6
EH, EHB	100 A	480Y/277 Vac	1, 2, 3	15-100	EH	See page 11-26
FC	100 A	480 Vac	2, 3	15-100	FC	See page 11-11
FD, FG, FJ	100 A	480Y/277 Vac	1, 2, 3	15-100	X	
GJL / NENL	100 A	480 Vac	3	15-100	X	
KA, KH, KC	250 A	480 Vac	2, 3	70-250	X	See page 11-6
FI, FIL	100 A	480 Vac	2, 3	20-100	X	
KI, KIL	225 A	480 Vac	2, 3	110-225	X	
LI, LIL	400 A	480 Vac	2, 3	300-400	X	
KD, KG	250 A	240 Vac	2, 3	100-250	X	See page 11-30
LA(JKL) 0000	400 A	600 Vac	2, 3	125-400	X	
MA-0000	1000 A	600 Vac	2, 3	125-1000	X	
Masterpact M/MP/MC	6300 A	600 Vac	3, 4	800-6300	—	See page 11-44 through page 11-48
MEC	225 A	600 Vac	2, 3	100-225	X	
MEC	400 A	600 Vac	2, 3	250-400	X	
MEC	800 A	600 Vac	2, 3	400-800	X	

11 OBSOLESCENT AND OBSOLETE CIRCUIT BREAKERS



by Schneider Electric

schneider-electric.us

Circuit Breaker Availability

Class 600

Obsolescent and Obsolete Types

Table 11.1 Circuit Breaker Availability (cont'd.)

Series of Cat. No.	Frame Size	Volts	Poles	Amperes	Availability	
					Obsolete No Longer Available	Obsolescent
MHAB, BC, CA	MM (Plug-on)	120/240 Vac	2 S.P.	15-50	X	
MHAB, BC, CA	M1 (Plug-on)	120/240 Vac	2, 3	15-70	X	
Q2, Q2-H, Q2H	225 A	240 Vac	2, 3	100-225	X	
QE	200 A	120/240 Vac	2, 3	70-200	X	See page 11-29
SE	4000 A	600 Vac	3	200-4000	X	
CK	1200 A	480 Vac	3	400-1200	X	
CM	2000 A	480 Vac	3	1250-2000	X	
XO	50 A	120/240 Vac	1, 2	15-50	X	
Y1B	100 A	277 Vac	1	15-100	X	
LXi	600 A	600 Vac	3	100-600	X	
ME, MEL	250 A, 400 A, 800 A	600 Vac	3	100-800	X	
MX, MXL	250 A, 400 A, 800 A	600 Vac	3	100-800	X	
NA, NAL	1200 A	600 Vac	3	600-1200	X	
NC, NCL	1200 A	600 Vac	3	600-1200	X	
NX, NXL	1200 A	600 Vac	3	600-1200	X	
NE, NEL	1200 A	600 Vac	3	600-1200	X	
PAF	2000 A	600 Vac	3	600-2000	X	
PHF	2000 A	600 Vac	2, 3	600-2000	X	
PCF	2500 A	600 Vac	2, 3	1600-2500	X	
PXF	2500 A	600 Vac	2, 3	600-2500	X	
PEF	2500 A	600 Vac	3	600-2500	X	

Contact your local Sales Office for availability.

Dimensions



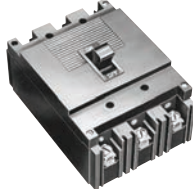
LIL



LA (W)



MA (W)



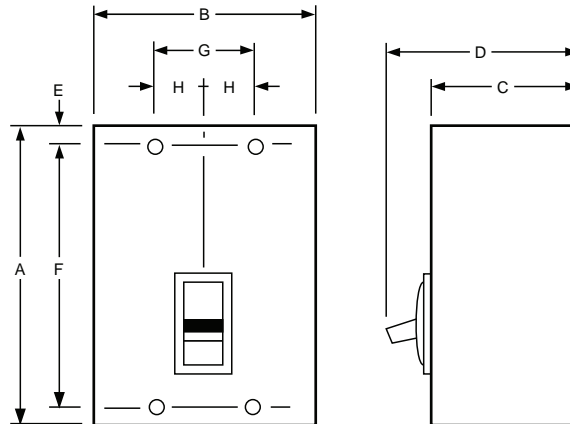
MIL-1



MIL-2

Table 11.2: Circuit Breaker Dimensions

Circuit Breaker Type	Cat. No. Prefix	Number Poles	Dimensions															
			A		B		C		D		E		F		G		H	
			in.	mm	in.	mm	in.	mm	in.	mm	in.	mm	in.	mm	in.	mm		
QB	991	1	3.75	95	1.00	25	2.50	63	3.06	78	—	—	—	—	—	—	—	
ML	992	1	6.00	152	1.00	25	3.09	78	3.91	99	.88	22	4.25	108	—	—	.33	8
	992	2	6.00	152	2.00	51	3.09	78	3.91	99	.88	22	4.25	108	—	—	.19	5
	992	3	6.00	152	3.00	76	3.09	78	3.91	99	.88	22	4.25	108	—	—	1.83	46
ML-1	999	2, 3	6.50	165	4.47	113	3.06	78	3.94	100	.94	24	4.25	108	1.50	38	.75	19
ML-2	994	2, 3	9.56	243	4.47	113	3.75	95	4.88	124	1.69	43	6.50	165	1.50	38	.75	19
ML-3	997	2, 3	10.38	264	5.97	152	3.88	98	5.31	135	1.69	43	6.63	168	2.00	51	1.00	25
LA (W)	LA	2, 3	10.75	273	8.25	209	4.31	109	5.50	140	.63	16	9.50	241	2.75	70	1.38	35
MA (W)	MA	2, 3	16.00	406	8.25	209	4.06	103	6.06	154	.88	22	14.25	362	2.75	70	1.38	35
KL	967	2, 3	22.00	559	8.25	209	5.50	140	7.00	178	.63	16	20.75	527	2.75	70	1.38	35
LM	940	2, 3	22.00	559	8.25	209	5.50	140	7.00	178	.63	16	20.75	527	2.75	70	1.38	35
FIL (4)	IFL	2, 3	8.29	210	4.46	113	3.67	93	4.70	119	.44	11	7.41	188	1.50	38	.75	19
KIL (4)	IKL	2, 3	11.00	279	6.00	152	4.02	102	5.51	140	.88	22	9.25	235	2.00	51	1.00	25
LIL	ILL	2, 3	11.00	279	12.00	305	4.05	103	6.11	155	.88	22	9.25	235	4.00	102	2.00	51
NHL	NHL	2, 3	20.00	508	12.00	305	5.75	146	8.12	206	5.87	149	7.76	197	4.00	102	2.00	51



11 OBSOLESCENT AND OBSOLETE CIRCUIT BREAKERS

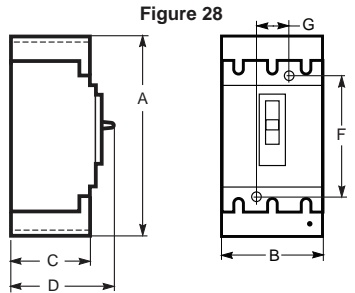
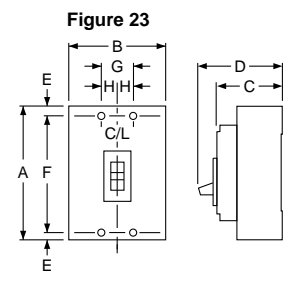
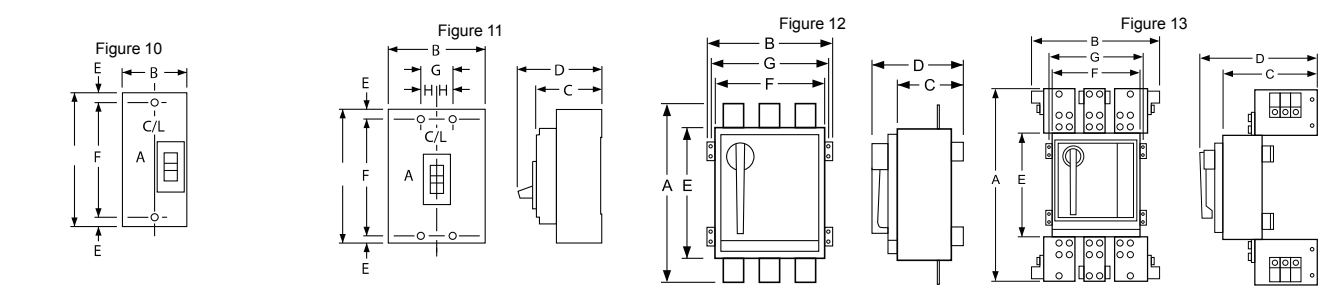
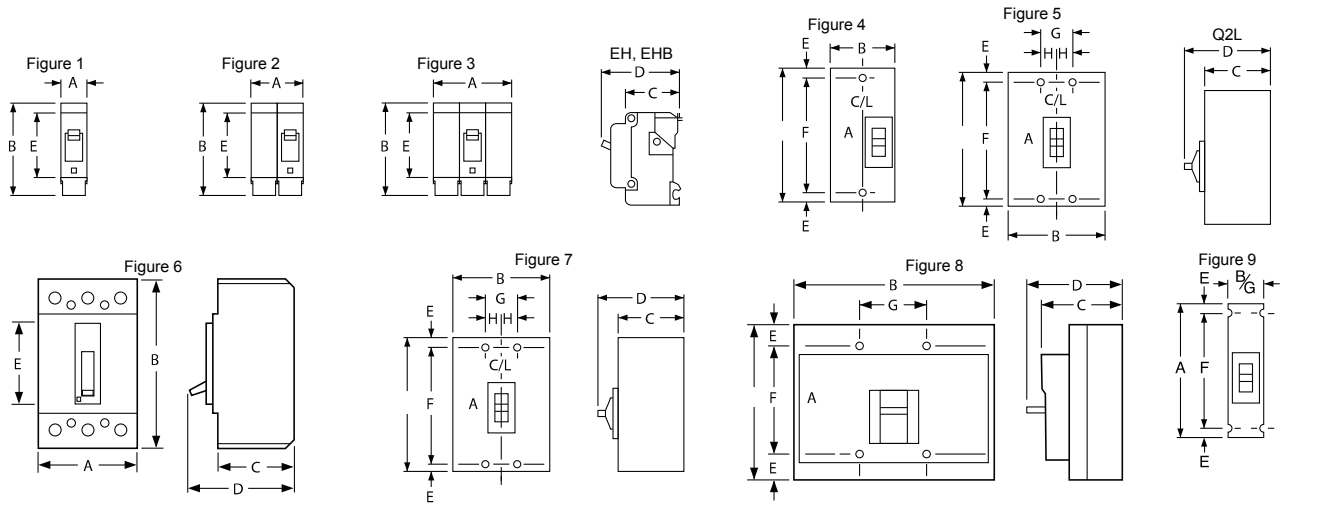


Table 11.4: Circuit Breaker Dimensions

Circuit Breaker Cat. No. Prefix	No. Poles	Fig. No.	Dimensions—In.							
			A	B	C	D	E	F	G	H
EH, EHB	1	1	1.00	3.50	2.00	2.97	2.44	—	—	—
	2	2	2.00	3.50 [1]	2.00	2.97	2.44	—	—	—
	3	3	3.00	3.50 [1]	2.00	2.97	2.44	—	—	—
FDA, FGA, FJA	1	Width 1.50								
	2, 3	Width 3.00								
FIL, KIL	2, 3	11	8.00	4.50	3.66	4.75	0.44	7.13	1.50	0.75
DG, DJ, DL	3	28	13.38	5.51	3.75	6.61	2.22	8.93	1.77	—
KAL, KCL, KHL	2, 3	23	8.00	4.50	3.66	4.75	0.44	7.13	1.50	0.75
KIL	2, 3	23	8.00	4.50	3.66	4.75	0.44	7.13	1.50	0.75
KD, KG	2, 3	6	4.12	7.35	3.20	4.17	3.34	—	—	—
LC, LI, LE, LX, LXI	2, 3	11	11.86	7.50	5.48	6.74	0.55	10.75	2.50	—
LIL, LXIL	2, 3	11	11.86	7.50	5.48	6.74	0.55	10.75	2.50	—
Q4L, LAL, LHL	2, 3	11	11.00	6.00	4.06	5.84	0.88	9.25	2.00	1.00
Q2L, Q2L-H	2	4	6.44	3.00	3.16	3.92	[2]	4.25	—	—
	3	5	6.44	4.50	3.16	3.92	[2]	4.25	1.50	0.75
MXL, MEL	2, 3	7	14.75	9.00	4.37	6.50	1.66	11.43	3.00	1.50
NAL, NCL, NEL, NXL	2, 3	8	12.12	14.98	6.40	8.07	1.69	8.75	5.00	—
FCL	1	9	6.00	1.50	3.16	4.13	0.44	5.13	1.50	—
	2	10	6.00	3.00 [3]	3.16	4.13	0.44	5.13	—	—
	3	11	6.00	4.50	3.16	4.13	0.44	5.13	1.50	0.75
MAL, MHL	2, 3	23	14.00	9.00	4.53	6.50	1.66	10.69	3.00	1.50
NA, NC, NX, NE	2, 3	8	12.12	14.98	6.40	8.07	1.69	8.75	5.0	—
PA, PH, PX, PE	2, 3	12	20.06	13.70	7.25	10.47	14.00	12.00	12.75	—
PC, PX-25, PE-20, PE-25	2, 3	13	26.10	23.30	13.33	16.55	14.10	12.00	—	—

Table 11.3: Shipping Weights

Frame Size	Approx. Shipping Weight (Lbs.)
FIL	8
KAL, KHL	7
MAL, MHL	34
PAF, PHF	69
PXF, PEF	80

[1] 70–100 A is 4.00 in.
[2] Dimensions E are 1.59 in at ON end and 0.63 in at OFF end.
[3] FCL 2-pole circuit breaker dimension B is 4.50 as in Fig. 23.



D-Frame Circuit Breaker

PowerPact D-Frame Circuit Breakers

Table 11.5: D-Frame 3P 600 A Circuit Breaker, Frame Only

Basic Frame Only (600 Vac) [1]			
Ampere Rating	Interrupting Rating		
	G	J	L
150 A	DGL36150F40	DJL36150F40	DLL36150F40
250 A	DGL36250F40	DJL36250F40	DLL36250F60
400 A	DGL36400F40	DJL36400F40	DLL36400F40
600 A	DGL36600F60	DJL36600F60	DLL36600F60

Table 11.6: D-Frame 3P 600 A Circuit Breaker Field-Installable Trip Units

Field Installable D-Frame Electronic Trip Unit Long-time, Short-time and Instantaneous Protection			
Description	Factory Code	Trip Function	Cat. No.
STR23SP	E20	LS	36940
STR53UP-F	E53	LSI	36942
STR53UP-FT	E54	LSIG	36943
STR53UP-FI	E58	LSI	36944
STR53UP-FTI	E59	LSIG	36945

Table 11.7: D-Frame (600 A 600 Vac) 3P 50/60 Hz Circuit Breaker with Lugs and Electronic Trip Units [2]

Electronic Trip Unit Type	Trip Function	Trip Unit	Continuous Current	Interrupting Rating			Terminal Wire Range (AWG/kcmil)
				Cat. No.	J	L	
Standard	LS	STR23SP	150 A	DGL36150E20	DJL36150E20	DLL36150E20	(1) 2–600 Cu or (1) 2–500 Al
			250 A	DGL36250E20	DJL36250E20	DLL36250E20	
			400 A	DGL36400E20	DJL36400E20	DLL36400E20	
			600 A	DGL36600E20	DJL36600E20	DLL36600E20	
	LSI	SR53UP-F [3]	150 A	DGL36150E53	DJL36150E53	DLL36150E53	(1) 2–600 Cu or (1) 2–500 Al
			250 A	DGL36250E53	DJL36250E53	DLL36250E53	
			400 A	DGL36400E53	DJL36400E53	DLL36400E53	
			600 A	DGL36600E53	DJL36600E53	DLL36600E53	
	LSIG	STR53UP-FT [3]	150 A	DGL36150E54	DJL36150E54	DLL36150E54	(1) 2–600 Cu or (1) 2–500 Al
			250 A	DGL36250E54	DJL36250E54	DLL36250E54	
			400 A	DGL36400E54	DJL36400E54	DLL36400E54	
			600 A	DGL36600E54	DJL36600E54	DLL36600E54	
Ammeter	LSI	STR53UP-FI [3]	150 A	DGL36150E58	DJL36150E58	DLL36150E58	(1) 2–600 Cu or (1) 2–500 Al
			250 A	DGL36250E58	DJL36250E58	DLL36250E58	
			400 A	DGL36400E58	DJL36400E58	DLL36400E58	
			600 A	DGL36600E58	DJL36600E58	DLL36600E58	
	LSIG	STR53UP-FTI [3]	150 A	DGL36150E59	DJL36150E59	DLL36150E59	(1) 2–600 Cu or (1) 2–500 Al
			250 A	DGL36250E59	DJL36250E59	DLL36250E59	
			400 A	DGL36400E59	DJL36400E59	DLL36400E59	
			600 A	DGL36600E59	DJL36600E59	DLL36600E59	

Table 11.8: D-Frame Interrupting Ratings

Voltage	Interrupting Rating		
	G	J	L
240 Vac	65 kA	100 kA	125 kA
480 Vac	35 kA	65 kA	100 kA
600 Vac	18 kA	25 kA	25 kA

Table 11.9: D-Frame Termination Options

Termination Letter	Termination Option
F	No Lugs (Includes terminal nut kit on both ends)
L	Lugs both ends
M	Lugs ON end Terminal Nut Kit Off end
P	Lugs OFF end Terminal Nut Kit On end
N	Plug-in
D	Drawout
S	Rear Connected

D G L 3 6 4 0 0

For factory-installed termination, place termination letter in the third block of the circuit breaker catalog number.

Termination Letter

D G L 3 6 4 0 0 E 2 0

Accessories see page 11-33

Dimensions see page 3-28

Table 11.10: Plug-In and Drawout Mountings for D-Frame Circuit Breakers

Description	Poles	Plug-in Mounting		Drawout Mounting		
		Factory Installed Cat. No.	Field-Installable Cat. No.	Factory Installed Cat. No.	Field-Installable Cat. No.	
Kit (stationary and moving parts)	3	N	32546	D	32548	
	4	N	M32547	D	M32549	
Stationary Part	3		32514		32514	
	4		M32515		M32515	
Moving Part			HJ00	HJ00		
	Fixed part of chassis				32532	
	Moving part of chassis				32533	
	Short terminal covers	3		32562		32562
		4		32563		32563
	Power connections	3	3x	32518	3x	32518
4		4x	32518	4x	32518	

Table 11.11: Plug-In and Drawout Accessories for D-Frame Circuit Breakers

Description	Field-Installed Cat. No.		
Secondary Disconnecting Blocks	Fixed Part	9-wire connector	29273
	Moving Part	9-wire connector	32523
		Support for 3 moving connectors	32525
Shutters	Two shutters for plug-in base	32521	
Chassis Accessories	Extended escutcheon for toggle	32534	
	Locking device (key lock is not included)	29286	
	Two position indicating switches (connected/disconnected)	29287	

[1] Available with lugs (L) or bus (F) connections only.

[2] D-frame circuit breakers 400 A and below are 100% rated. 600 A is standard (80%) rated only.

[3] F = Fault indicator; T = Residual-type ground-fault protection; I = Ammeter



Table 11.12: PV Circuit Breaker Max. Interrupting Ratings

Frame	600 Vdc	1000 Vdc
T-Frame	10 kA	3 kA
U-Frame	10 kA	5 kA

The UL listed thermal-magnetic molded case circuit breakers and switches shown below are specifically designed for use in PV applications, rated at 50°C, offering grounded or ungrounded configurations.

The products are fully tested and calibrated under the PV UL489B standard.

The products come ready to install, including specially designed serial connectors for optimal thermal response, and adapted terminal covers for optimal isolation. Circuit Breakers come 100% rated for ease of use and selection.

These two new frames are fully compatible with the current line of PowerPact accessories, from aux contacts and shunt trips to motor operators and rotary handles.

Table 11.13: PV Molded Case Circuit Breakers

Ampere Rating	600 Vdc (3 poles)		1000 Vdc (4 poles)	
	Ungrounded Part Number	Grounded Part Number	Ungrounded Part Number	Grounded Part Number
50	TGL36050L	TGL36050K	TBL41050L	TBL41050K
60	TGL36060L	TGL36060K	TBL41060L	TBL41060K
70	TGL36070L	TGL36070K	TBL41070L	TBL41070K
80	TGL36080L	TGL36080K	TBL41080L	TBL41080K
100	TGL36100L	TGL36100K	TBL41100L	TBL41100K
125	TGL36125L	TGL36125K	TBL41125L	TBL41125K
150	TGL36150L	TGL36150K	TBL41150L	TBL41150K
175	TGL36175L	TGL36175K	TBL41175L	TBL41175K
200	TGL36200L	TGL36200K	TBL41200L	TBL41200K
225	UGL36225L	UGL36225K	UCL41225L	UCL41225K
250	UGL36250L	UGL36250K	UCL41250L	UCL41250K
300	UGL36300L	UGL36300K	UCL41300L	UCL41300K
350	UGL36350L	UGL36350K	UCL41350L	UCL41350K
400	UGL36400L	UGL36400K	UCL41400L	UCL41400K
450	UGL36450L	UGL36450K	UCL41450L	UCL41450K
500 [4]	N/A	UGL36500G	UCL41500J	UCL41500G

Table 11.14: Circuit Breaker Numbering

Brand	Frame	Rating	Termination	Poles	Voltage	Amperage	Grounding	Suffix Code	Suffix Code
Blank	T	G	L	3	6	0 5 0	G	A B	S A
Brand Blank: Schneider Electric	Frame T: T-Frame U: U-Frame	Ratings B: 3 kA C: 5 kA G: 10 kA	Terminations L: Lugs Line/Load Side F: Bus Bar S: Rear Connected	Poles 3: 3P 4: 4P	Voltage 6: 600 Vdc 1: 1000 Vdc	Amperage 050: 50 A 060: 60 A 070: 70 A 080: 80 A 100: 100 A 125: 125 A 150: 150 A 175: 175 A 200: 200 A 225: 225 A 250: 250 A 300: 300 A 350: 350 A 400: 400 A 450: 450 A 500: 500 A	Grounding G: Grounded, 80% rated (500 A Only) J: Ungrounded, 80% rated (500 A Only) K: Grounded, 100% rated L: Ungrounded, 100% rated	Accessory Suffix Cells (See page 11-9)	

[4] 500 A 80% rated.

Table 11.15: PV Switches Withstand Ratings

Frame	600/1000 Vdc
T-Frame	3 kA
U-Frame	7.5 kA

Table 11.16: PV Molded Case Non-Automatic Switches

Ampere Rating	600 Vdc		1000 Vdc	
	Ungrounded Part Number	Grounded Part Number	Ungrounded Part Number	Grounded Part Number
100	TBL36000JZ10	TBL36000GZ10	TBL41000JZ10	TBL41000GZ10
150	TBL36000JZ15	TBL36000GZ15	TBL41000JZ15	TBL41000GZ15
200	TBL36000JZ20	TBL36000GZ20	TBL41000JZ20	TBL41000GZ20
250	UDL36000JZ25	UDL36000GZ25	UDL41000JZ25	UDL41000GZ25
300	UDL36000JZ30	UDL36000GZ30	UDL41000JZ30	UDL41000GZ30
400	UDL36000JZ40	UDL36000GZ40	UDL41000JZ40	UDL41000GZ40
500	UDL36000JZ50	UDL36000GZ50	UDL41000JZ50	UDL41000GZ50

Table 11.17: Switch Numbering

Brand	Frame	Rating	Termination	Poles	Voltage	Amperage	Grounding	Trip System	Suffix Code	Suffix Code	
	T	D	L	3	6	0 0 0	G	Z	1	0	A B S A
Brand Blank: Schneider Electric only	Frame T: T-Frame U: U-Frame	Ratings B: 3 kA D: 7.5 kA	Terminations L: Lugs Line/Load Side F: Bus Bar S: Rear Connected	Poles 3: 3P 4: 4P	Voltage 6: 600 Vdc 1: 1000 Vdc	Amperage 000: Switch	Grounding G: Grounded, 80% rated J: Ungrounded, 80% rated	Trip System—## (Z: Non-Automatic Switch) (##: Amperage Rating) Z10: 100 A Z15: 150 A Z20: 200 A Z25: 250 A Z30: 300 A Z40: 400 A Z50: 500 A	Accessory Suffix Cells (See page 11-9)		

Table 11.18: Auxiliary Switches

Contacts	Factory-Installed Suffix	Field-Installable Kit No.	Kit Qty.
1A/1B Standard	AA	S29450	1
2A/2B Standard	AB	S29450	2
3A/3B Standard [5]	AC	S29450	3
1A/1B Low-Level (Gold)	AE	S29452	1
2A/2B Low-Level (Gold)	AF	S29452	2
3A/3B Low-Level (Gold) [5]	AG	S29452	3

Table 11.19: Alarm/Overcurrent Trip Switches

Suffix	Switch	Kit No.	Kit Qty.
PowerPact T-Frame			
BC	Alarm Switch	S29450	1
BH	Alarm Switch, Low-Level	S29452	1
BD	Overcurrent Trip Switch, Standard	S29450	1
	SDE Actuator	S29451	1
BJ	Overcurrent Trip Switch, Low-Level	S29452	1
	SDE Actuator	S29451	1
BE	Alarm Switch and Overcurrent Trip Switch, Standard	S29450	2
	SDE Actuators	S29451	2
BK	Alarm Switch and Overcurrent Trip Switch, Low-Level	S29452	2
	SDE Actuators	S29451	2
PowerPact U-Frame			
BC	Alarm Switch	S29450	1
BH	Alarm Switch, Low-Level	S29452	1
BD	Overcurrent Trip Switch, Standard	S29450	1
BJ	Overcurrent Trip Switch, Low-Level	S29452	1
BE	Alarm Switch and Overcurrent Trip Switch, Standard	S29450	2
BK	Alarm Switch and Overcurrent Trip Switch, Low-Level	S29452	2

Table 11.20: Shunt Trips and Undervoltage Trips

Voltage	Shunt Trip (MX)		Undervoltage Trip (MN) Field-Installable Kit No.	Adjustable and Fixed Time Delay Units for Undervoltage Trip Field-Installable Kit No.
	Suffix	Field-Installable Kit No.		
120 Vac	SA	S29386	—	—
24 Vdc	SO	S29390	—	—
48 Vdc	SP	S29392	—	—
125 Vdc	SR	S29393	—	—

Table 11.21: Rotary Operated Handles

Device	Description	Factory Installed Suffix	T-Frame Field Installable Kit No.	U-Frame Field Installable Kit No.
Direct Mounted	Standard Handle Black	RD10	S29337	S32597
Door Mounted	Standard Black Handle	RE10	S29338	S32598

Table 11.22: Locks

Device	Description	Factory Installed Suffix	T-Frame Field Installable Kit No.	U-Frame Field Installable Kit No.
Handle Padlocking Device	Handle Padlock, ON or OFF	YP	S29371	S32631

NOTE: For a complete list of Field installable accessories and details, including also motor operator (electrical only) and locks, refer to accessories information for the PowerPact, J-Frame (compatible with T-Frame) and L-Frame (Compatible with U-Frame). Or consult Photovoltaic offer catalog 0611CT1302.

Table 11.23: PV Unit Mount Terminal Covers

Frame	Description [6]	Poles	Configuration				Field-Installable Kit No.
			Ungrounded		Grounded		
			Top	Bottom	Top	Bottom	
T-Frame	Long Terminal Cover (3P)	3	X	—	—	—	S35175
	Long Terminal Cover (3P/1SC)	3	—	X	X	X	S35176
	Long Terminal Cover (4P)	4	—	X	—	—	S35177
	Long Terminal Cover (4P/2SC)	4	X	—	X	—	S35178
	Long Terminal Cover (4P/1SC)	4	—	—	—	X	S35179
U-Frame	Long Terminal Cover (3P)	3	X	—	—	—	S32593
	Extended Term Cover (3P/1SC)	3	—	X	X	X	S38291
	Long Terminal Cover (4P)	4	—	X	—	—	S32594
	Extended Term Cover (4P/2SC)	4	X	—	X	—	S38293
	Extended Term Cover (4P/1SC)	4	—	—	—	X	S38294

Table 11.24: PV Rear Connection Terminal Covers and Connectors

Frame	Description [7]	Poles	Configuration				Field Installable Catalog No.
			Ungrounded		Grounded		
			Top	Bottom	Top	Bottom	
T-Frame	Short Terminal Cover (3P)	3	X	—	—	—	S29515

[5] U-Frame only.
[6] P: Poles, SC: Serial connector.
[7] P: Poles, SC: Serial connector.

Table 11.24 PV Rear Connection Terminal Covers and Connectors (cont'd.)

Frame	Description [8]	Poles	Configuration				Field Installable Catalog No.
			Ungrounded		Grounded		
			Top	Bottom	Top	Bottom	
	Long Terminal Cover (3P/1SC)	3	—	X	X	X	S35169
	Short Terminal Cover (4P)	4	—	X	—	—	S29516
	Long Terminal Cover (4P/1SC)	4	—	—	—	X	S35170
	Long Terminal Cover (4P/2SC)	4	X	—	X	—	S35178
	Short Rear Connector (set of 2) [8]	3, 4	—	X	—	X	S29235
	Long Rear Connector (set of 2) [8]	3, 4	—	X	—	—	S29236
U-Frame	Short Terminal Cover (3P)	3	X	—	—	—	S32562
	Extended Terminal Cover (3P/1SC)	3	—	X	X	X	S35171
	Short Terminal Cover (4P)	4	—	X	—	—	S32563
	Extended Term Cover (4P/1SC)	4	—	—	—	X	S35172
	Extended Term Cover (4P/2SC)	4	X	—	X	—	S38293
	Short Rear Connector (set of 2) [8][9]	3, 4	—	X	—	X	S432475
Long Rear Connector (set of 2) [8][9]	3, 4	—	X	—	—	S432476	

Table 11.25: PV T-Frame Bus Bar and Rear Connections Hardware

Description	Cat. No.
T-Frame Term Nut Insert-Metric/M8 (12)	S30554

Table 11.26: PV U-Frame Bus Bar and Rear Connections Hardware

Description	Cat. No.
Set of 4 M10 x 25 terminal screws and washers for one side	S36967

Table 11.27: Mechanical Lug Kits for T- and U-Frame Circuit Breakers and Switches

Frame	Description	Conductor			Current	Cat. No.	Qty. Per Kit
		Type	No. Per Lug	Size			
T-Frame	Lug(2) T-Frame, 12-4 AWG, Al/Cu	Al	1	#12-#4 AWG (4-25 mm ²)	50-60 A	S35167	2
		Cu	1	#14-#4 AWG (2.5-25 mm ²)			
	Lugs(2) T-Frame, 4-4/0 AWG, Al/Cu	Al/Cu	1	#4-#4/0 AWG (25-95 mm ²)	70-150 A	S29255	2
		Lug(2) T-Frame, 250-350 kcmil, Al/Cu	Al	1	#250-350 AWG (120-185 mm ²)	175-200 A	S35168
Cu	1		#2/0-350 AWG (70-185 mm ²)				
U-Frame	Lug(2) U-Frame, 2/0 AWG-500 kcmil, Al/Cu	Al	2	2/0 AWG-500 kcmil (70-240 mm ²)	225-500 A	S35180	2
		Cu	2	2/0 AWG-500 kcmil (70-240 mm ²)			

NOTE: For availability dates of field-installable accessories in Tables 7.156, 7.157, 7.158 and 7.160 contact Schneider Electric.

[8] P: Poles, SC: Serial connector.
 [8] The ungrounded configurations (3P or 4P) need 2 short and 2 long rear connectors. The grounded configurations only use 2 short rear connectors.
 [9] Parts only, no hardware is included. See page 11-10

F-Frame Circuit Breakers

NOTE: FC circuit breakers are obsolete. Please refer to Digest for PowerPact™ molded case circuit breakers for new installations or replacement.

Thermal-magnetic molded case circuit breakers shown on page 11-11 are permanent trip UL Listed, CSA Certified, IEC rated, and also meet the requirements of Federal Specification W-C-375B/GEN as indicated in Digest Section 7.

NOTE: Consider using PowerPact circuit breakers for situations requiring circuit breaker accessories. See Digest Section 7 for more information.



FAL/FHL 2P
15-100 A



FAL/FHL 3P
15-100 A



FA 2P
3 in. (76 mm)
Mounting Height



FA 3P
4.5 in. (114 mm)
Mounting Height

Table 11.28: F-Frame—100 A, Thermal-Magnetic, Individually-Mounted, 480 Vac

Ampere Rating	Fixed AC Magnetic Trip		Extra-High Interrupting		Terminal Wire Range (AWG)
	Hold	Trip	2P Cat. No. 480 Vac, 250 Vdc	3P Cat. No. 480 Vac, 250 Vdc	
15 A	275 A	600 A	—	FCL34015	CU30FA4 (1) 14-10 Cu
20 A	275 A	600 A	—	FCL34020	
25 A	275 A	600 A	—	FCL34025	
30 A	275 A	600 A	—	FCL34030	
35 A	400 A	850 A	—	FCL34035	
40 A	400 A	850 A	—	FCL34040	AL100FA4 (1) 14-3 Cu or (2) 12-1 Al
45 A	400 A	850 A	—	FCL34045	
50 A	400 A	850 A	FCL24050	FCL34050	
60 A	800 A	1450 A	FCL24060	FCL34060	
70 A	800 A	1450 A	FCL24070	FCL34070	
80 A	800 A	1450 A	FCL24080	FCL34080	
90 A	900 A	1700 A	FCL24090	FCL34090	
100 A	900 A	1700 A	FCL24100	FCL34100	

Table 11.29: Interrupting Ratings

Voltage	FAL			FHL	FCL	FIL
	240 Vac	480 Vac	600 Vac			
240 Vac	10 kA	18 kA (1P), 25 kA (2P, 3P)	25 kA	25 kA (1P) 65 kA (2P, 3P)	100 kA	200 kA
480 Vac	—	18 kA	18 kA	25 kA (2P, 3P)	65 kA	200 kA
600 Vac	—	—	14 kA	18 kA (2P, 3P)	—	100 kA

Table 11.30: Termination Option

Termination Letter	Termination Letter
F = No Lugs	For factory-installed termination, place termination letter in the third block of the circuit breaker catalog number. F A L 3 6 1 0 0
L = Lugs both ends	
P with MT Suffix = Lugs ON end	
P = Lugs OFF end	

Table 11.31: F-Frame—100 A, Thermal-Magnetic, I-Line™ Construction, 480 Vac

Ampere Rating	Fixed AC Magnetic Trip		Extra-High Interrupting		Terminal Wire Range (AWG)
	Hold	Trip	2P [10] Cat. No. 480 Vac [11]	3P Cat. No. 480 Vac	
15 A	275 A	600 A	—	FC34015	CU30FA4 (1) 14-10 Cu
20 A	275 A	600 A	—	FC34020	
25 A	275 A	600 A	—	FC34025	
30 A	275 A	600 A	—	FC34030	
35 A	400 A	850 A	—	FC34035	
40 A	400 A	850 A	—	FC34040	AL100FA4 (1) 14-3 Cu or (1) 12-1 Al
45 A	400 A	850 A	—	FC34045	
50 A	400 A	850 A	FC24050()	FC34050	
60 A	800 A	1450 A	FC24060()	FC34060	
70 A	800 A	1450 A	FC24070()	FC34070	
80 A	800 A	1450 A	FC24080()	FC34080	
90 A	900 A	1700 A	FC24090()	FC34090	
100 A	900 A	1700 A	FC24100()	FC34100	

Table 11.33: Interrupting Ratings

240 Vac	FA		FH	FC	FI
	480 Vac	600 Vac			
10 kA	18 kA (1P), 25 kA (2P, 3P)	25 kA	25 kA (1P) 65 kA (2P, 3P)	100 kA	200 kA
—	18 kA	—	—	65 kA	—
—	18 kA	18 kA	25 kA (2P, 3P)	65 kA	200 kA
—	—	14 kA	18 kA (2P, 3P)	—	100 kA

Accessories see page 11-33
Optional Lugs see page 11-39
Dimensions see page 11-4
Enclosures: see Digest Section 7

Table 11.32: Phase Options

Phase Option Letter	1P	2P	3P
A	FA14035A	—	—
B	FA14035B	—	—
C	FA14035C	—	—
AB	—	FA24030AB	—
AC	—	FA24030AC	—
BC	—	FA24030BC	—
ABC	—	—	FA34030
CBA	—	—	FA34030CBA

[10] 1P and 2P circuit breaker catalog numbers are completed by adding the required phase connection letters as a suffix. See Phase Options Table.

[11] FCL 2P circuit breakers are built using 3P module.

K-Frame Circuit Breakers

NOTE: K-frame circuit breakers are obsolete. Please refer to Digest for PowerPact™ molded case circuit breakers for new installations or replacement.

Table 11.36: K-Frame—250 A, Thermal-Magnetic, Individually-Mounted, 600 Vac

Ampere Rating	Adjustable AC Magnetic Trip [12]		Cat. No.				Terminal Wire Range	
	Low	High	Standard Interrupting	High Interrupting	Extra-High Interrupting [13]	Current Limiting		
2P, 600 Vac, 250 Vdc								
70	350 A	700 A	KAL26070	KHL26070	—	—	AL250KA (1) 4 AWG–350 kcmil Al	
80	400 A	800 A	KAL26080	KHL26080	—	—		
90	450 A	900 A	KAL26090	KHL26090	—	—		
100	500 A	1000 A	KAL26100	KHL26100	—	—		
110	550 A	1100 A	KAL26110	KHL26110	KCL24110	KIL26110		
125	625 A	1250 A	KAL26125	KHL26125	KCL24125	KIL26125		
150	750 A	1500 A	KAL26150	KHL26150	KCL24150	KIL26150		
175	875 A	1750 A	KAL26175	KHL26175	KCL24175	KIL26175		
200	1000 A	2000 A	KAL26200	KHL26200	KCL24200	KIL26200		
225	1125 A	2250 A	KAL26225	KHL26225	KCL24225	KIL26225		
250	1250 A	2500 A	KAL26250	KHL26250	KCL24250	KIL26250		
3P, 600 Vac, 250 Vdc								
70	350 A	700 A	KAL36070	KHL36070	—	—		AL250KA (1) 4 AWG–350 kcmil Al
80	400 A	800 A	KAL36080	KHL36080	—	—		
90	450 A	900 A	KAL36090	KHL36090	—	—		
100	500 A	1000 A	KAL36100	KHL36100	—	—		
110	550 A	1100 A	KAL36110	KHL36110	KCL34110	KIL36110		
125	625 A	1250 A	KAL36125	KHL36125	KCL34125	KIL36125		
150	750 A	1500 A	KAL36150	KHL36150	KCL34150	KIL36150		
175	875 A	1750 A	KAL36175	KHL36175	KCL34175	KIL36175		
200	1000 A	2000 A	KAL36200	KHL36200	KCL34200	KIL36200		
225	1125 A	2250 A	KAL36225	KHL36225	KCL34225	KIL36225		
250	1250 A	2500 A	KAL36250	KHL36250	KCL34250	KIL36250		



KAL/KHL
2P and 3P
70–250 a



KIL36250



KA/KH/KC 2P and 3P
4.5 IN. (114 mm)
Mounting Height

Table 11.34: Phase Options

Phase Option Letter	2P	3P
AB	KA26250AB	—
AC	KA26250AC	—
BC	KA26250BC	—
ABC	—	KA36250
CBA	—	KA36250CBA

Table 11.35: Interrupting Ratings

Voltage	KA, KAL	KH, KHL	KC, KCL	KI, KIL
240 Vac	42 kA	65 kA	100 kA	200 kA
480 Vac	25 kA	35 kA	65 kA	200 kA
600 Vac	22 kA	25 kA	—	100 kA

Accessories see page 11-37
Optional Lugs see page 3-25
Dimensions see page 3-28
Enclosures: see Digest Section 7

Table 11.37: K-Frame—250A, Thermal-Magnetic, I-Line™ Construction, 600 Vac

Ampere Rating	Adjustable AC Magnetic Trip [12]		Cat. No.				Terminal Wire Range	
	Low	High	Standard Interrupting	High Interrupting	Extra-High Interrupting [13]	Current Limiting		
2P, 600 Vac, 250 Vdc [14]								
70	350 A	700 A	KA26070()	KH26070()	—	—	AL250KA (1) 4 AWG–350 kcmil Al	
80	400 A	800 A	KA26080()	KH26080()	—	—		
90	450 A	900 A	KA26090()	KH26090()	—	—		
100	500 A	1000 A	KA26100()	KH26100()	—	—		
110	550 A	1100 A	KA26110()	KH26110()	KC24110()	KI26110()		
125	625 A	1250 A	KA26125()	KH26125()	KC24125()	KI26125()		
150	750 A	1500 A	KA26150()	KH26150()	KC24150()	KI26150()		
175	875 A	1750 A	KA26175()	KH26175()	KC24175()	KI26175()		
200	1000 A	2000 A	KA26200()	KH26200()	KC24200()	KI26200()		
225	1125 A	2250 A	KA26225()	KH26225()	KC24225()	KI26225()		
250	1250 A	2500 A	KA26250()	KH26250()	KC24250()	KI26250()		
3P, 600 Vac, 250 Vdc								
70	350 A	700 A	KA36070	KH36070	—	—		AL250KA (1) 4 AWG–350 kcmil Al
80	400 A	800 A	KA36080	KH36080	—	—		
90	450 A	900 A	KA36090	KH36090	—	—		
100	500 A	1000 A	KA36100	KH36100	—	—		
110	550 A	1100 A	KA36110	KH36110	KC34110	KI36110		
125	625 A	1250 A	KA36125	KH36125	KC34125	KI36125		
150	750 A	1500 A	KA36150	KH36150	KC34150	KI36150		
175	875 A	1750 A	KA36175	KH36175	KC34175	KI36175		
200	1000 A	2000 A	KA36200	KH36200	KC34200	KI36200		
225	1125 A	2250 A	KA36225	KH36225	KC34225	KI36225		
250	1250 A	2500 A	KA36250	KH36250	KC34250	KI36250		

Table 11.38: Walking Beam Mechanical Interlock Components [15][16]

Circuit Breaker Prefix	Manually Operated			Electrically Operated		
	Operator Suffix	Walking Beam Ass'y. Cat. No.	Mounting Pan Cat. No.	Operator Suffix	Walking Beam Ass'y. Cat. No.	Mounting Pan Cat. No.
KAL	WB	KA4WB	KAWB P4	WBMO	KA9WB	KAWB P9



[12] UL magnetic trip setting tolerances are ±25% for low and ±20% for high from nominal value shown.

[13] KC circuit breakers are 480 Vac.

[14] 2P and 3P circuit breaker catalog numbers are completed by adding the required phase connection letters as a suffix. See Phase Options Table.

[15] Walking Beam Mechanical Interlock requires 2 circuit breakers with WB suffix, 1 walking beam assembly and 1 mounting pan.

[16] Fully enclosed interlocked units are available in Type 1 and Type 3R enclosures, with two neutrals provided in each enclosure. The completely enclosed assembly is not UL Listed. Contact the nearest sales office for more information.



LIL36600
2P and 3P 300–600 A

L-Frame Molded Case Circuit Breaker

NOTE: Consider using PowerPact™ circuit breakers for situations requiring circuit breaker accessories. See Digest for more information.

Table 11.39: L-Frame—600 A, Current-Limiting, Individually-Mounted Circuit Breakers, 600 Vac

Ampere Rating	Adjustable AC Magnetic Trip		Cat. No.		Terminal Wire Range
	Low	High	Extra-High Interrupting	Current Limiting	
2P, 600 Vac					
300 A	1500 A	3200 A	LCL26300	LIL26300	AL600LI5 (2) 4/0 AWG–500 kcmil Al
350 A	1750 A	3200 A	LCL26350	LIL26350	
400 A	2000 A	3200 A	LCL26400	LIL26400	
450 A	2250 A	4200 A	LCL26450	LIL26450	
500 A	2500 A	4200 A	LCL26500	LIL26500	
600 A	3000 A	4200 A	LCL26600	LIL26600	
3P, 600 Vac					
300 A	1500 A	3200 A	LCL36300	LIL36300	AL600LI5 (2) 4/0 AWG–500 kcmil Al
350 A	1750 A	3200 A	LCL36350	LIL36350	
400 A	2000 A	3200 A	LCL36400	LIL36400	
450 A	2250 A	4200 A	LCL36450	LIL36450	
500 A	2500 A	4200 A	LCL36500	LIL36500	
600 A	3000 A	4200 A	LCL36600	LIL36600	

Table 11.40: Interrupting Ratings

Voltage	LCL	LIL
240 Vac	100 kA	200 kA
480 Vac	65 kA	200 kA
600 Vac	35 kA	100 kA

Accessories see [page 11-37](#)
Optional Lugs see [page 3-25](#)
Dimensions see [page 3-28](#)
Enclosures see Digest Section 7



Micrologic Standard-Function Trip Systems (LXL, LXIL)



Micrologic Full-Function Trip Systems (LEL)

Standard-Function Features:

- 80% rated
- True RMS sensing
- Interchangeable rating plugs
- LSI, LS(I)G, trip configurations
- Short-time delay = I^2t IN and ground-fault delay = I^2t OUT
- Integral ground-fault testing
- LED long-time pickup indication
- Thermal and magnetic backup protection
- Long-time and ground-fault memory
- Optional local trip indicators—overload, short circuit, ground-fault
- Optional local ammeter/trip indicator
- Universal test set available
- Optional I-Line™ mounting (LX, LXI)
- Optional neutral current transformer for 4-wire systems

Full-Function Features:

- 100% rated (600 A sensor LE/LEL circuit breakers are 80% rated)
- True RMS sensing
- Interchangeable rating plugs
- PowerLogic™ compatible
- LI, LIG, LS(I), LS(I)G (instantaneous OFF) configurations
- Short-time delay = I^2t IN & I^2t OUT and ground-fault delay = I^2t IN & I^2t OUT
- Short-time withstand rating
- Integral ground-fault testing
- Optional ground-fault alarm (no trip) (Requires CIM3F with PowerLogic, see Bulletin 0502DB0001.)
- LED long-time pickup indication
- Zone-selective interlocking (short-time & ground-fault)
- Long-time and ground-fault memory
- Local Trip Indicators—overload, short circuit, ground-fault
- Local ammeter/trip indicator
- Universal test set available
- Optional I-Line™ mounting (LE)
- Optional neutral current transformer for 4-wire systems

11-14
OBSCULENT AND OBSOLETE
CIRCUIT BREAKERS

L-Frame, Individually Mounted

Table 11.41: L-Frame—600 A, Micrologic Series B Trip System, Individually-Mounted, 3P, 600 Vac

Sensor Size	Ampere Rating	Trip Function	Cat. No.			Installed Rating Plug	Terminal Wire Range			
			Standard Function	Standard Function Current Limiting	100% Rated Full Function [17]					
250	100	LI	—	—	LEL36100LI	ARP040	AL600LI5 (2) 1 AWG–350 kcmil Al/Cu			
		LSI	LXL36100	LXIL36100	LEL36100LS					
		LIG	—	—	LEL36100LIG					
	LSIG	LXL36100G	LXIL36100G	LEL36100LSG	ARP050					
	LI	—	—	LEL36125LI						
	LSI	LXL36125	LXIL36125	LEL36125LS						
	125	125	LIG	—	—	LEL36125LIG		ARP050		
			LSIG	LXL36125G	LXIL36125G	LEL36125LSG				
			LI	—	—	LEL36150LI			ARP060	
	150	150	LSI	LXL36150	LXIL36150	LEL36150LS		ARP060		
			LIG	—	—	LEL36150LIG				
			LSIG	LXL36150G	LXIL36150G	LEL36150LSG				
	250	175	LI	—	—	LEL36175LI		ARP070		
			LSI	LXL36175	LXIL36175	LEL36175LS				
			LIG	—	—	LEL36175LIG				
		200	200	LSIG	LXL36175G	LXIL36175G		LEL36175LSG	ARP070	
				LI	—	—		LEL36200LI		ARP080
				LSI	LXL36200	LXIL36200		LEL36200LS		
		225	225	LIG	—	—		LEL36200LIG	ARP080	
				LSIG	LXL36200G	LXIL36200G		LEL36200LSG		
				LI	—	—		LEL36225LI		ARP090
		250	250	LSI	LXL36225	LXIL36225		LEL36225LS	ARP090	
				LIG	—	—		LEL36225LIG		
				LSIG	LXL36225G	LXIL36225G		LEL36225LSG		
400	300	LI	—	—	LEL36250LI	ARP100				
		LSI	LXL36250	LXIL36250	LEL36250LS					
		LIG	—	—	LEL36250LIG					
	350	350	LSIG	LXL36250G	LXIL36250G	LEL36250LSG	ARP100			
			LI	—	—	LEL36300LI		ARP075		
			LSI	LXL36300	LXIL36300	LEL36300LS				
	400	400	LIG	—	—	LEL36300LIG	ARP075			
			LSIG	LXL36300G	LXIL36300G	LEL36300LSG				
			LI	—	—	LEL36350LI		ARP088		
	450	450	LSI	LXL36350	LXIL36350	LEL36350LS	ARP088			
			LIG	—	—	LEL36350LIG				
			LSIG	LXL36350G	LXIL36350G	LEL36350LSG				
600	450	LI	—	—	LEL36400LI	ARP100				
		LSI	LXL36400	LXIL36400	LEL36400LS					
		LIG	—	—	LEL36400LIG					
	500	500	LSIG	LXL36400G	LXIL36400G	LEL36400LSG	ARP100			
			LI	—	—	LEL36450LI		ARP075		
			LSI	LXL36450	LXIL36450	LEL36450LS				
	600 [18]	600	LIG	—	—	LEL36450LIG	ARP075			
			LSIG	LXL36450G	LXIL36450G	LEL36450LSG				
			LI	—	—	LEL36500LI		ARP083		
	600	600	LSI	LXL36500	LXIL36500	LEL36500LS	ARP083			
			LIG	—	—	LEL36500LIG				
			LSIG	LXL36500G	LXIL36500G	LEL36500LSG				
600	600	LI	—	—	LEL36600LI	ARP100				
		LSI	LXL36600	LXIL36600	LEL36600LS					
		LIG	—	—	LEL36600LIG					
		LSIG	LXL36600G	LXIL36600G	LEL36600LSG					

NOTE: Consider using PowerPact™ circuit breakers for situations requiring circuit breaker accessories.

Table 11.42: Interrupting Ratings

Voltage	LXL	LEL	LXIL
240 V	100 kA	100 kA	200 kA
480 V	65 kA	65 kA	200 kA
600 V	35 kA	35 kA	100 kA

Accessories see page 11-37
Optional Lugs see page 3-25
Dimensions see page 3-28

[17] Substitute (A) in place of (G) for ground-fault alarm (pickup indication only). Requires CIM3F and Powerlogic, or see Data Bulletin 0502DB0001. No instantaneous OFF position for LI or LIG trip function type circuit breakers.

[18] 600 A Sensor is 80% rated.

L-Frame Micrologic™ Series B Trip Circuit Breakers

NOTE: Consider using PowerPact™ circuit breakers for situations requiring circuit breaker accessories. See Digest Section 7 for more information.

Table 11.43: L-Frame—600 A, Micrologic Series B Trip System, I-Line™ Construction, 3P, 600 Vac [19]

Ampere Rating	Trip Function	Cat. No.			Installed Rating Plug	Terminal Wire Range		
		Standard Function	Standard Function Current Limiting	100% Rated Full Function [20]				
100	LI	—	—	LE36100LI	ARP040	(2) 1 AWG–350 kcmil Al/Cu		
	LSI	LX36100	LXI36100	LE36100LS				
	LIG	—	—	LE36100LIG				
	LSIG	LX36100G	LXI36100G	LE36100LSG				
125	LI	—	—	LE36125LI	ARP050		(2) 1 AWG–350 kcmil Al/Cu	
	LSI	LX36125	LXI36125	LE36125LS				
	LIG	—	—	LE36125LIG				
	LSIG	LX36125G	LXI36125G	LE36125LSG				
150	LI	—	—	LE36150LI	ARP060			(2) 1 AWG–350 kcmil Al/Cu
	LSI	LX36150	LXI36150	LE36150LS				
	LIG	—	—	LE36150LIG				
	LSIG	LX36150G	LXI36150G	LE36150LSG				
175	LI	—	—	LE36175LI	ARP070	(2) 1 AWG–350 kcmil Al/Cu		
	LSI	LX36175	LXI36175	LE36175LS				
	LIG	—	—	LE36175LIG				
	LSIG	LXL36175G	LXI36175G	LE36175LSG				
200	LI	—	—	LE36200LI	ARP080		(2) 1 AWG–350 kcmil Al/Cu	
	LSI	LX36200	LXI36200	LE36200LS				
	LIG	—	—	LE36200LIG				
	LSIG	LX36200G	LXI36200G	LE36200LSG				
225	LI	—	—	LE36225LI	ARP090			(2) 1 AWG–350 kcmil Al/Cu
	LSI	LX36225	LXI36225	LE36225LS				
	LIG	—	—	LE36225LIG				
	LSIG	LX36225G	LXI36225G	LE36225LSG				
250	LI	—	—	LE36250LI	ARP100	(2) 1 AWG–350 kcmil Al/Cu		
	LSI	LX36250	LXI36250	LE36250LS				
	LIG	—	—	LE36250LIG				
	LSIG	LX36250G	LXI36250G	LE36250LSG				
300	LI	—	—	LE36300LI	ARP075		(2) 4/0 AWG– 500 kcmil Al/Cu	
	LSI	LX36300	LXI36300	LE36300LS				
	LIG	—	—	LE36300LIG				
	LSIG	LX36300G	LXI36300G	LE36300LSG				
350	LI	—	—	LE36350LI	ARP088			(2) 4/0 AWG– 500 kcmil Al/Cu
	LSI	LX36350	LXI36350	LE36350LS				
	LIG	—	—	LE36350LIG				
	LSIG	LX36350G	LXI36350G	LE36350LSG				
400	LI	—	—	LE36400LI	ARP100	(2) 4/0 AWG– 500 kcmil Al/Cu		
	LSI	LX36400	LXI36400	LE36400LS				
	LIG	—	—	LE36400LIG				
	LSIG	LX36400G	LXI36400G	LE36400LSG				
450	LI	—	—	LE36450LI	ARP075		(2) 4/0 AWG– 500 kcmil Al/Cu	
	LSI	LX36450	LXI36450	LE36450LS				
	LIG	—	—	LE36450LIG				
	LSIG	LX36450G	LXI36450G	LE36450LSG				
500	LI	—	—	LE36500LI	ARP083			(2) 4/0 AWG– 500 kcmil Al/Cu
	LSI	LX36500	LXI36500	LE36500LS				
	LIG	—	—	LE36500LIG				
	LSIG	LX36500G	LXI36500G	LE36500LSG				
600 [21]	LI	—	—	LE36600LI	ARP100	(2) 4/0 AWG– 500 kcmil Al/Cu		
	LSI	LX36600	LXI36600	LE36600LS				
	LIG	—	—	LE36600LIG				
	LSIG	LX36600G	LXI36600G	LE36600LSG				

Table 11.44: Interrupting Ratings

Voltage	LX	LE	LXI
240 Vac	100 kA	100 kA	200 kA
480 Vac	65 kA	65 kA	200 kA
600 Vac	35 kA	35 kA	100 kA

Accessories see page 11-37
 Optional Lugs see page 3-25
 Dimensions see page 3-28

[19] Type LX, LXI and LE circuit breakers are NOT recommended for use on single motor branch circuits.

[20] Substitute (A) in place of (G) for ground-fault alarm (pickup indication only). Requires CIM3F and Powerlogic, or see Data Bulletin 0502DB0001. No instantaneous OFF position for LI or LIG trip function type circuit breakers.

[21] 600 A Sensor is 80% rated.

PowerPact™ Mission Critical Circuit Breakers

PowerPact D-Frame Mission Critical Circuit Breakers

When the D-frame Mission Critical circuit breaker is used as a main circuit breaker with QO branch circuit breakers, the D-frame MC will remain closed during any fault that occurs downstream of the QO circuit breaker up to 30kA at 208Y/120 Vac.

Ratings:

- UL 489 Listed
- CSA Certified
- Voltage: 208Y/120 V
- Handle ratings: 60–600 A
- AIR: 65 kA

Available Configurations:

- Four sizes: 150 A, 250 A, 400 A, and 600 A
- Main circuit breaker in NQ panelboards
- Unit mount for OEM users
- Plug-in base for OEM users
- Drawout base for OEM users

Table 11.45: D-Frame Termination Options

Frame	Termination Letter	Termination Option
D-Frame	F	No Lugs (Includes terminal nut kit on both ends)
	L	Lugs both ends
	M	Lugs ON end Terminal Nut Kit Off end
	P	Lugs OFF end Terminal Nut Kit On end
	N	Plug-in
	S	Rear Connected

For factory-installed termination, place termination letter in the third block of the circuit breaker catalog number.
D G L 3 6 4 0 0 E 2 0

Table 11.46: D-Frame Mission Critical Circuit Breakers

Circuit Breaker Cat. No. [22]	Continuous Current Rating	Terminal	
		Cat. No.	Wire Range (AWG/kcmil)
DJL32150W	150 A	32508	#2-600 Cu or #2-500 Al
DJL32250W	250 A		
DJL32400W	400 A		
DJL32600W	600 A	32510	(2) 2/0-350 Cu or (2) 2/0-500Al

Accessories see page 11-33
Optional Lugs see page 3-25
Dimensions see page 3-28



LA/LHL MC
For Mission Critical Power Loads
Available in 200, 225, 250, and 400 A
@ 480 Vac

LA Mission Critical Circuit Breakers

The LA High Magnetic Withstand MC Circuit Breakers are designed to trip at a higher magnetic trip level (18–20 times handle rating) than typical molded case circuit breakers (MCCBs) (which trip at 5–10 times the handle rating).

The high magnetic withstand value of these LA circuit breakers allow the downstream branch circuit breaker to clear the fault.

Table 11.48: L-Frame—400 A, Thermal-Magnetic, High Magnetic Withstand Circuit Breakers For Mission Critical Loads

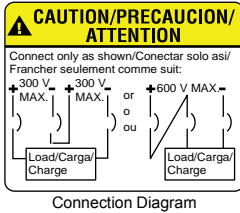
Ampere Rating	AC Magnetic Level Factory Set		Circuit Breaker		Terminal	
	Hold	Trip	Standard Interrupting Cat. No.	High Interrupting Cat. No.	Cat. No.	Wire Range
LA/LH MC Circuit Breaker, 3P, 480 Vac						
200 A	3400 A	4000 A	LAL34200MC	LHL34200MC	AL250-LAMC	(1) 250–350 kcmil Al (1) 3/0 AWG–350 kcmil Cu
225 A	3825 A	4500 A	LAL34225MC	LHL34225MC		
250 A	4250 A	5000 A	LAL34250MC	LHL34250MC	AL400LA	(1) 1 AWG–600 kcmil Al or (2) 1 AWG–250 kcmil Al
400 A	6000 A	7200 A	LAL34400MC	LHL34400MC		

Table 11.47: L-Frame Interrupting Table

	LAL	LHL
240 Vac	42 kA	65 kA
480 Vac	30 kA	35 kA

Accessories see page 11-37
Optional Lugs see page 3-25
Dimensions see page 3-28

[22] D-Frame circuit breakers 400 A and below are 100% rated.



500 Vdc Circuit Breakers

The UL Listed thermal-magnetic molded case circuit breakers shown below are specifically designed for use on ungrounded dc systems having a maximum floating (unloaded) voltage of 600 Vdc. The circuit breakers are suitable for use only with UPS (uninterruptible power supplies) and ungrounded systems.

This two-level voltage rating allows these circuit breakers to be applied to battery sources having a short-circuit availability of 20,000 amperes for LH, and MH circuit breakers and 25,000 amperes for PAF circuit breakers at 500 Vdc.

LH and MH circuit breakers are provided with an adjustable magnetic trip that is readily accessible by means of a single adjustment on the face of the circuit breaker. PAF circuit breakers have a fixed magnetic trip range.

These circuit breakers are UL Listed for the interrupting ratings shown only if applied with three poles connected in series (series connection is external to circuit breaker). See diagram.

Obsolete DC circuit breakers are listed below. New PowerPact and Masterpact DC circuit breakers can be found in Digest Section 7.

NOTE: Due to external series connection, I-Line™ circuit breakers are not available for this application.

Table 11.49: Obsolete DC Molded Case Circuit Breakers

Ampere Rating	Circuit Breaker Cat. No.	Adjustable Magnetic Trip Range—DC Amperes ^[23]		Interrupting Rating @ 500 Vdc
		Low	High	
250 A	LHL3625025DC	625	1250	20 k AIR
300 A	LHL3630026DC	750	1500	
350 A	LHL3635029DC	875	1750	
400 A	LHL3640030DC	1000	2000	
450 A	MHL3645031DC	1125	2250	
500 A	MHL3650032DC	1250	2500	20 k AIR
600 A	MHL3660033DC	1500	3000	
700 A	MHL3670035DC	1750	3500	
800 A	MHL3680036DC	2000	4000	
900 A	MHL3690039DC	2500	5000	
1000 A	MHL36100040DC	2500	5000	25 k AIR
1200 A	MHL36120040DC [24]	2500	5000	
450 A	MHL3645031DCH	1125	2250	
500 A	MHL3650032DCH	1250	2500	
600 A	MHL3660033DCH	1500	3000	
700 A	MHL3670035DCH	1750	3500	
800 A	MHL3680036DCH	2000	4000	
900 A	MHL3690039DCH	2500	5000	
1000 A	MHL36100040DCH	2500	5000	
1200 A	MHL36120040DCH [24]	2500	5000	50 k AIR

Table 11.50: DC Molded Case Circuit Breakers—Fixed Magnetic Trip

Ampere Rating	Circuit Breaker Cat. No.	Fixed Magnetic Trip Range—DC Amperes ^[23]		Interrupting Rating @ 500 Vdc
		Hold	Trip	
1200 A	PAF361200DC	1200	1620	25 k AIR
1600 A	PAF361600DC	1600	2160	
2000 A	PAF362000DC	2000	2700	
2500 A	PCF362500DC	2500	3375	

Accessories see Supplemental Digest Section 3 and Digest Section 7

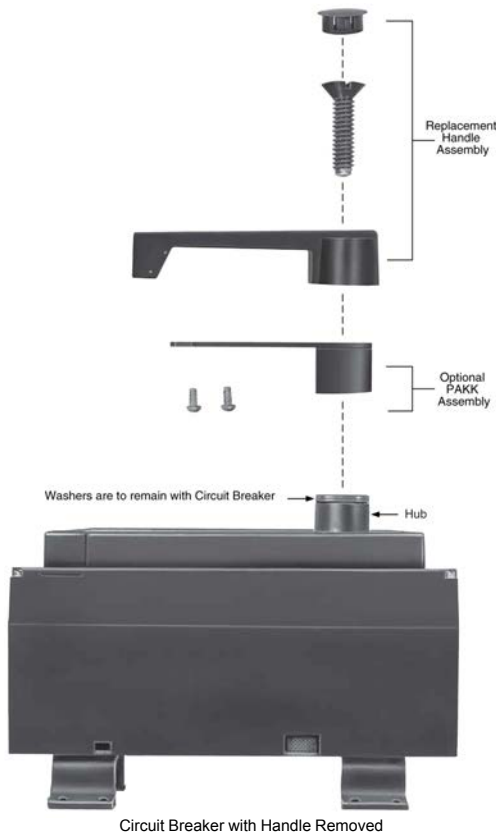
Optional Lugs see Supplemental Digest Section 3 and Digest Section 7

Dimensions see Digest Section 7

Enclosures see Digest Section 7

[23] Magnetic trip tolerances are -20%/+30% from the nominal values shown.

[24] Suitable for use only in ventilated enclosure. Minimum enclosure dimensions are 38" h x 20" w x 7" d with a minimum of 300 square inches of ventilation near the top and bottom of the enclosure.



P-Frame Replacement Handle

NOTE: The “hub” under normal conditions is insulated. When the phenolic handle is removed, a label is exposed warning of the hub being energized. That can only happen if a short circuit or severe overload occurs. The ionized gasses inside the circuit breaker could momentarily (1-2 cycles) put a high voltage potential on the hub.

Replacement handle assemblies for PA, PC, PE, PX and PH circuit breakers (produced after March 1975) are available.

Table 11.51: P-Frame Replacement Handle

Circuit Breaker Cat. No. Prefix	Replacement Handle Cat. No.
PAF, PAE, PHF, PHE, PCF, PEC, PEF, PXF	HRPA

P-Frame Key Interlock Adapter Plate

PAKK Kit – An adapter plate that is added under the circuit breaker handle to allow mechanical interlocking with a key interlock (not included). The kit includes all the necessary hardware to mount onto the circuit breaker handle.

Table 11.52: P-Frame Key Interlock Adapter Plate

Cat. No.
PAKK

Exchange Guarantee Prices, Permanent Trip Molded Case Circuit Breakers

When a Square D permanent trip circuit breaker is supplied to meet a specification requiring an interchangeable trip unit, it may be exchanged for another circuit breaker of the same type with a different trip setting.

When entering an order for the replacement circuit breaker:

- Reference “Exchange Price Guarantee” as a line item marking on the replacement order. The replacement order will be billed at normal authorized selling net price.
- Request Return Material Authorization referencing “Exchange Price Guarantee” and the replacement exchange price guarantee invoice number.

When the circuit breaker is returned to Cedar Rapids, credit will be issued for the difference between the replacement net price billed and the exchange list price (from the table below) times the same multiplier used on the replacement order. The list price used to determine credit will be based on the highest trip setting of the circuit breakers involved in the exchange.

Only those circuit breaker types below are eligible for this exchange guarantee program.

Table 11.53: Exchange Guarantee Circuit Breakers

Circuit Breaker Type	Trip Range
LA	All
LH	All
LC	All

Automatic Molded Case Switches

NOTE: These automatic molded case switches are in obsolescence. Do not use on new applications. Limited service stock is available for replacement or fill purposes. Contact the nearest sales office for product availability.

Automatic molded case switches open instantaneously at a factory preset magnetic trip point, calibrated to protect only the molded case switch itself, when it is subjected to high fault currents. The trip point is nonadjustable and provides no overload or low level fault protection.

Molded case switches open when the handle is switched to the OFF position or in response to an auxiliary tripping device such as a shunt trip.

Automatic switches will accept the same lugs and accessories as equivalent thermal-magnetic circuit breakers.

Automatic molded case switches are UL Listed per UL 489 and are CSA Certified.

Table 11.54: Automatic Molded Case Switches, 600 Vac

Ampere Rating	2P		3P		Withstand Rating ^{[25][26]}				Trip Point (A) ^[27]		Lug Kit Installed
	Cat. No.	Availability	Cat. No.	Availability	240 Vac	480 Vac	600 Vac	250 Vdc	AC	DC	
100	FHL26000M ^[28]	—	FHL36000M ^[28]	—	65k	25k	18k	10k	1500	1725	AL100FA
150	—	—	FHL3600015M ^[28]	—	65k	25k	18k	—	2500	—	AL150FA
400	LHL26000M	—	LHL36000M	—	65k	35k	25k	10k	8000	9600	AL400LA
250	KHL26000M ^[28]	Not Available	KHL36000M ^[28]	Not Available	65k	35k	25k	10k	4500	5175	AL250KA
600	MHL260006M	Not Available	MHL360006M	—	65k	65k	25k	10k	9000	9900	AL900MA
800	MHL260008M	Not Available	MHL360008M	—	65k	65k	25k	10k	9000	9900	AL900MA



D-Frame Switch

Table 11.56: D-Frame (600 Vac) and Q-Frame (240 Vac) PowerPact™ Automatic Molded Case Switches

Circuit Breaker	Poles	Ampere Rating	J Interrupting Rating		Terminal	Wire Range
			Cat. No.	Trip Point		
D-Frame	3	400 A	DJL36000S40	6000 A	S32508	2 AWG–500 kcmil Al or 2 AWG–600 kcmil Cu
		600 A	DJL36000S60	6000 A	S32510	(2) 2/0 AWG–500 kcmil Al or (2) 2/0 AWG–350 kcmil Cu

Table 11.55: D-Frame Withstand Ratings ^[29]

Voltage	Interrupting Rating
	J
240 Vac	150 kA
480 Vac	100 kA
600 Vac	25 kA

Accessories see page 11-37
Optional Lugs see page 3-25
Dimensions see page 3-28

^[25] The withstand rating is the fault current at rated voltage that the molded case switch will withstand without damage when protected by a circuit breaker with an equal continuous current rating.

^[26] The short circuit current rating is the fault current, at rated voltage, that the molded case switch will withstand without damage when protected by a circuit breaker with an equal continuous current rating.

^[27] UL magnetic trip tolerances are -20% / +30% from the nominal values shown.

^[28] FHL and KHL automatic switches will not accept cylinder lock attachments.

^[29] The withstand rating is the fault current at rated voltage that the molded case switch will withstand without damage when protected by a circuit breaker with an equal continuous current rating.

Mag-Gard Motor Circuit Protector

NOTE: These Mag-Gard motor circuit protectors are obsolete. Please refer to Digest Section 7 for PowerPact™ molded case circuit breakers for new installations or replacement.

Instantaneous trip magnetic only circuit breakers have a single adjustment which simultaneously sets the magnetic trip level of each individual pole. Mag-Gard circuit breakers comply with NEC® requirements for providing motor circuit protection when installed as part of a UL Listed combination controller having motor overload protection. Interrupting ratings are established for these UL Recognized Components only when they are used in combination with motor starters with properly sized overload relays and contactors.

Mag-Gard circuit breakers will accept the same lugs and accessories as equivalent thermal-magnetic circuit breakers. Mag-Gard circuit breakers are available with I-Line construction. H-construction Mag-Gard circuit breakers are also available.

Table 11.57: Magnetic Only 3–1200 A 600 Vac, 50/60 Hz

Ampere Rating		Adjustable Trip Range [30]	Cat. No. 3P only
KAL	150 A	750–1500 A	KAL3615026M
		400–800 A	KAL3625021M
	250 A	750–1500 A	KAL3625026M
		1000–2000 A	KAL3625030M
		1125–2250 A	KAL3625031M
		1250–2500 A	KAL3625032M
FAL	3 A	8–28 A	FAL3600311M
		18–70 A	FAL3600712M
		50–180 A	FAL3601513M
	15 A	50–180 A	FAL3603013M
		100–350	FAL3603015M
	30 A	75–260	FAL3603014M
		150–580 A	FAL3605016M
	50 A	150–580 A	FAL3610016M
		300–1100 A	FAL3610018M



Accessories see page 11-37
Optional Lugs see page 3-25
Dimensions see page 3-28

Adjustable instantaneous-trip circuit breakers are intended for use in combination with motor starters with overload relays for the protection of motor circuits from short circuits. Other specific applications include rectifiers and resistance welders. These circuit breakers contain a magnetic trip element in each pole with the trip point adjustable from the front. Interrupting ratings are determined by testing the instantaneous-trip circuit breakers in combination with a contactor and overload relay.

Select instantaneous-trip circuit breakers as follows:

- Use selection table for motors, other than NEMA Design E, with locked-rotor indicating code letters per NEC Table 430.7 (b) as follows. For other motors order a special thermal-magnetic circuit breaker with magnetic trip settings for the specific motor—specify motor horsepower, voltage, frequency, full-load current and code letter or locked rotor current.

Horsepower	Motor Code Letters
1/2 or less	A–L
3/4 to 1-1/2	A–K
2 to 3	A–J
5 to 25	A–H
30 to 125	A–G
150 or more	A–F

- Determine motor hp rating from the motor nameplate.
- Refer to the table and select an instantaneous-trip circuit breaker with an ampere rating recommended for the hp and voltage involved.
- Select an adjustable trip setting of at least 800%, not to exceed 1300%, of the motor full-load Amperes. (FLA) for other than Design E motors. For Design E motors, select an adjustable trip setting of at least 1100% not to exceed 1700% of FLA.
- The NEC 1300% maximum setting may be inadequate for instantaneous-trip circuit breakers to withstand current surges typical of the magnetization current of autotransformer type reduced voltage starters, or open transition wye-delta starters during transfer from “start” to “run,” constant hp multi-speed motors, and motors labeled “high efficiency.” Select thermal-magnetic circuit breakers from Digest Section 7 for those applications.
- Part-winding motors, per NEC 430.3, should have two circuit breakers selected from the above at not more than one half the allowable trip setting for the horsepower rating. The two circuit breakers should operate simultaneously as a disconnecting means per NEC 430.103.

[30] UL magnetic trip setting tolerances are -20%/+30% from the nominal values shown.

Table 11.58: Adjustable Instantaneous-Trip Circuit Breakers for Single Motor Circuit Protection

Hp Ratings of Induction Type Squirrel-Cage and Wound Rotor Motors 3Ø 60 Hz ac				Full Load Amperes [31]	Mag-Gard Circuit Breaker Cat. No.	Magnetic Trip Settings [32]	
200 V	230 V	460 V	575 V			MIN	MAX
			1/2	0.8	FAL3600311M [31]	1000%	3500%
		1/2		1	FAL3600311M [31]	800%	2800%
			3/4	1.1	FAL3600311M	700%	2500%
		3/4		1.4	FAL3600311M	600%	2000%
			1	1.8	FAL3600311M	400%	1600%
	1/2			2	FAL3600311M	400%	1400%
			1-1/2	2.1	FAL3600311M	400%	1300%
1/2				2.3	FAL3600311M	300%	1200%
		1-1/2		2.6	FAL3600712M	700%	2700%
			2	2.7	FAL3600712M	700%	2600%
	3/4			2.8	FAL3600712M	600%	2500%
3/4				3.2	FAL3600712M	600%	2200%
		2		3.4	FAL3600712M	500%	2100%
	1			3.6	FAL3600712M	500%	1900%
			3	3.9	FAL3600712M	500%	1800%
1				4.1	FAL3600712M	400%	1700%
		3		4.8	FAL3600712M	400%	1500%
	1-1/2			5.2	FAL3600712M	300%	1300%
1-1/2				6	FAL3600712M	300%	1200%
			5	6.1	FAL3600712M	300%	1100%
	2			6.8	FAL3601513M	700%	2600%
		5		7.6	FAL3601513M	700%	2400%
2				7.8	FAL3601513M	600%	2300%
			7-1/2	9	FAL3601513M	600%	2000%
	3			9.6	FAL3601513M	500%	1900%
3		7-1/2	10	11	FAL3601513M	500%	1600%
		10		14	FAL3603015M	700%	2500%
	5			15.2	FAL3603015M	700%	2300%
			15	17	FAL3603015M	600%	2100%
5				17.5	FAL3603015M	600%	2000%
		15		21	FAL3603015M	500%	1700%
	7-1/2		20	22	FAL3605016M	700%	2600%
7-1/2				25.3	FAL3605016M	600%	2300%
		20	25	27	FAL3605016M	600%	2100%
	10			28	FAL3605016M	500%	2100%
			30	32	FAL3605016M	500%	1800%
10				32.2	FAL3605016M	500%	1800%
		25		34	FAL3605016M	400%	1700%
		30		40	FAL3605016M	400%	1500%
			40	41	FAL3610018M	700%	2700%
	15			42	FAL3610018M	700%	2600%
15				48.3	FAL3610018M	600%	2300%
		40	50	52	FAL3610018M	600%	2100%
	20			54	FAL3610018M	600%	2000%
20			60	62	FAL3610018M	500%	1800%
		50		65	FAL3610018M	500%	1700%
	25			68	FAL3610018M	400%	1600%
30				92	KAL3625025M	700%	1400%
	40			104	KAL3625026M	700%	1400%
			150	144	KAL3625030M	700%	1400%
50				150	KAL3625030M	700%	1300%
	60			154	KAL3625031M	700%	1500%
		125		156	KAL3625031M	700%	1400%
60				177.1	KAL3625032M	700%	1400%
		150		180	KAL3625032M	700%	1400%
	75		200	192	KAL3625032M	700%	1300%

11 OBSOLESCENT AND OBSOLETE CIRCUIT BREAKERS

[31] Motor full-load currents are taken from NEC Table 430.150. Select wire and circuit breakers on basis of horsepower rather than nameplate full-load current per NEC 430.6 (A) for general motor applications. Do not use these values to select overload relay thermal units. See Digest Section 15 for selection of thermal units when actual full load current is not known. The voltages listed are rated motor voltages. Corresponding nominal system voltages are 200 to 208, 220 to 240, 440 to 480 and 550 to 600 volts.

[32] Only MIN and MAX settings are shown, intermediate settings are available on all circuit breakers.

Marine Circuit Breakers

NOTE: These marine circuit breakers are obsolete. Please refer to Digest Section 7 for PowerPact™ molded case circuit breakers for new installations or replacement.

A standard for molded case circuit breakers which are intended to be installed and used aboard a boat or vessel is included in Supplement SA to UL 489, “Standard for Molded Case Circuit Breakers and Circuit Breaker Enclosures” (also referred to as UL product category DKTY). This UL Standard was established in accordance with U.S. Coast Guard regulations, applicable American Boat and Yacht Council Inc. publications, and NFPA® 302 “Standard for Motor Craft (Pleasure and Commercial)”. In order to be UL Listed for marine use, circuit breakers must not use aluminum or aluminum alloys for terminal connections and must be calibrated at an ambient temperature of 40°C. Standard circuit breakers should not be specified or used in place of marine circuit breakers.

The following table lists those circuit breakers which are UL Marine Listed for use on vessels over 65 ft. (19.8 m) in length. (PowerPact H and J-frame circuit breakers can also be used in vessels under 65 ft. [19.8 m] in length.)

Table 11.59: Circuit Breakers for Marine Applications

Cat. No. Prefix	Poles	Ampere Rating	Application	Cat. No.
FC, FCL	2, 3	15–100 A	For use only on vessels over 65 feet (19.8 m) in length.	Add the number “9” after the catalog number prefix of the standard circuit breaker catalog number. Example: Standard FAL36100 Marine FAL936100
FI, FIL	2, 3	20–100 A		
KI, KIL	2, 3	110–250 A		
KA, KAL	2, 3	70–250 A		
KH, KHL	2, 3	70–250 A		
KC, KCL	2, 3	110–250 A		



For use on vessels over 65 ft. (19.8 m) in length.

Branch Circuit Breakers and Mounting Assemblies for ML Panelboards

NOTE: NQO, NQOB, and NQOD circuit breakers and panelboards are obsolete. Do not use on new applications. Limited service stock is available for replacement or fill purposes. Contact the nearest sales office for product availability.

Replacing Obsolescent Q1 and Q1B Circuit Breakers In NQO, NQOB and NQOD Panelboards

Q1 and Q1B circuit breakers have been replaced by QO and QOB circuit breakers.

Table 1 below is used for replacing 1P, 2P or 3P Q1 and Q1B circuit breakers with QO and QOB branch circuit breakers in NQO, NQOB and NQOD panelboards.

Table 2 below is used for replacing Q1 and Q1B main circuit breakers in NQO and NQOB panelboards.



2P QO



2P QOB



2P Q1

Table 11.60: Replacing Q1 and Q1B Circuit Breakers with QO and QOB Branch Circuit Breakers

Panelboard Type	Branch Circuit Breaker		Mounting Assembly Required
	Obsolete	Available	
NQOB	Q1B	QOB	SK5668
NQOD	—	QO	SKNQOD225 [33]
NQOD	—	QOB	SKNQOD225 [33]

Table 11.61: Replacing Q1 and Q1B Main Circuit Breakers in NQO and NQOB Panelboards

Panelboard Type	Main Circuit Breaker		Mounting Assembly Required	Retaining Kit Required
	Obsolete	Available		
NQOB	Q1B	QOB	SK5668	—

Branch Circuit Breakers and Mounting Assemblies for ML Panelboards

Replacement circuit breakers for ML panelboards are determined by the manufacture date of the panel and the panel depth. (See chart below.)

Table 11.62: Replacement Circuit Breakers in ML Panelboards

Manufacture Date	Panel Depth		Availability of Replacement Circuit Breakers
	in.	mm	
1948–1956	8.63	219	No Replacements Available
1958–1961	10.00	254	No Replacements Available
1962–1968	10.63	270	Refer to Tables Below

The tables below are used for replacing or adding circuit breakers to 10-5/8 inch deep ML panelboards manufactured from 1962–1968 and for switchboards manufactured from 1962–1968.

Table 11.63: Adding New Circuit Breakers

Cat. No. Prefix	Ampere Rating	Mounting Assembly Required	Mounting Height		Poles Required	Single or Twin (Mounting Assembly)
			in.	mm		
FAL	15–100 A	SK4515	4.50	114	3P	Twin
KAL	70–250 A	SK4516	4.50	114	3P	Twin
LAL	125–400 A	SK4517	6.00	152	3P	Single
MAL	300–1000 A	SK4578	9.00	229	3P	Single

Table 11.64: Replacement of Existing Circuit Breakers

Existing Circuit Breaker	Ampere Rating	Mounting Height		Cat. No. Prefix	Replacement Circuit Breaker	Mounting Assembly Required	Poles Required	Single or Twin (Mounting Assembly)	Availability
		in.	mm						
ML-1	15–100 A	4.50	114	989 or 999	FAL	SK4515 [34]	3P	Twin	—
ML-3	100–225 A	6.00	152	997	KAL	SK4516 [34]	3P	Twin	—
LA (W)	225–400	8.25	210	LA	LAL	SK4517	3P	Single	—
MA (W)	125–1000 A	8.25	210	MA	MAL	SK4578	3P	Single	—
FAL	15–100 A	4.50	114	FAL	FAL	No Mounting Assembly Required	3P	Twin	Not Available
KAL	70–250 A	4.50	114	KAL	KAL		3P	Twin	
LAL	125–400 A	6.00	152	LAL	LAL		3P	Single	
MAL	300–1000 A	9.00	229	MAL	MAL		3P	Single	
MAL	125–250 A	9.00	229	MAL	LAL		SK4517	3P	

[33] 225 A maximum. For 400–600 ampere circuit breaker mounting assembly, see Class 1630 Service Bulletin.

[34] Mounting assemblies for twin-mounted circuit breakers will only accept the same family and configuration of circuit breakers, i.e., FAL and FAL.

NOTE: These rating plugs are for electronic circuit breakers which are obsolete. Please refer to Digest Section 7 for PowerPact™ circuit breakers for new installations or replacement.



ME Micrologic
Circuit Breakers



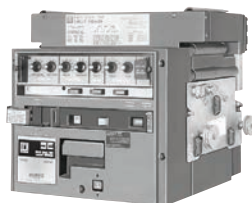
ME Circuit Breakers
Manufactured
before Micrologic



PE Micrologic
Circuit Breakers



PE Circuit Breakers
Manufactured
before Micrologic



SE Micrologic
Circuit Breakers

Rating Plugs for Obsolete Circuit Breakers

Replacement rating plugs for circuit breakers manufactured before Micrologic™.

Table 11.65: Replacement Rating Plugs for Pre-Micrologic Circuit Breakers

Circuit Breakers Manufactured Before Micrologic	Frame Size	Ampere Rating	Cat. No.	
ME	225 A	100 A	ME2100	
		110 A	ME2110	
		125 A	ME2125	
		150 A	ME2150	
		175 A	ME2175	
	400 A	250 A	ME4250	
		350 A	ME4350	
		450 A	ME8450	
	800 A	500 A	ME8500	
		700 A	ME8700	
600 A		PE120600		
700 A		PE120700		
PE-G/PEC-G Built before June 1, 1982 and all PE/PEC	1200 A	800 A	PE120800	
		900 A	PE120900	
		1200 A	PE121200	
		1000 A	PE161000	
	1600 A	1200 A	PE161200	
		1400 A	PE161400	
	2000 A	1000 A	PE161000	
		1200 A	PE161200	
		1400 A	PE161400	
		1800 A	PE201800	
	PE-G/PEC-G Built after June 1, 1982	1200 A	2000 A	PE202000
			600 A	PEG120600
			700 A	PEG120700
			800 A	PEG120800
		1600 A	1000 A	PEG121000
			1200 A	PEG121200
1000 A			PEG161000	
2000 A		1200 A	PEG161200	
		1400 A	PEG161400	
		1000 A	PEG161000	
		1200 A	PEG161200	
		1400 A	PEG161400	
2000 A	1800 A	PEG201800		
	2000 A	PEG202000		

Table 11.66: Interchangeable Rating Plug Kits for ME, NE, PE and SE Circuit Breakers with Full-Function Micrologic Trip System Manufactured Between December 1989 and September 1992

Old Cat. No.	New Cat. No.	Multiplier Value
RP040	ARP040	0.400
RP050	ARP050	0.500
RP056	ARP056	0.563
RP058	ARP058	0.583
RP060	ARP060	0.600
RP063	ARP063	0.625
RP067	ARP067	0.667
RP070	ARP070	0.700
RP075	ARP075	0.750
RP080	ARP080	0.800
RP083	ARP083	0.833
RP088	ARP088	0.875
RP090	ARP090	0.900
RP100	ARP100	1.000





Table 11.67: Replacement Rating Plugs for Micrologic Circuit Breakers

Circuit Breaker	Frame Size	Ampere Rating	Cat. No. [35]		
Micrologic ME Series 3	225 A	100 A	ME2100RP		
		110 A	ME2110RP		
		150 A	ME2150RP		
		175 A	ME2175RP		
	400 A	250 A	ME4250RP		
		450 A	ME8450RP		
		500 A	ME8500RP		
		700 A	ME8700RP		
	Micrologic NE Series 1	1200 A	600 A	NE120600RP	
			630 A	NE120630RP	
			700 A	NE120700RP	
			800 A	NE120800RP	
900 A			NE120900RP		
1000 A			NE121000RP		
Micrologic PE Series 4			1200 A	600 A	PE120600RP
				700 A	PE120700RP
				1000 A	PE121000RP
			1600 A	1200 A	PE161000RP
	1200 A	PE161200RP			
	Micrologic SE Series 2	2000 A	1000 A	PE201000RP	
1200 A			PE201200RP		
1400 A			PE201400RP		
1600 A			PE201600RP		
1800 A			PE201800RP		
Micrologic SE Series 2			200 A	100 A	S9020100RP
				125 A	S9020125RP
				150 A	S9020150RP
				175 A	S9020175RP
			400 A	200 A	S9020200RP
	250 A	S9040250RP			
	300 A	S9040300RP			
	350 A	S9040350RP			
	800 A	450 A	S9080450RP		
		500 A	S9080500RP		
		700 A	S9080700RP		
		800 A	S9120800RP		
1200 A	1000 A	S9121000RP			
	1200 A	S9121200RP			
	1600 A	S9161600RP			
	2000 A	S9202000RP			

EH/EHB Circuit Breakers

NOTE: EH/EHB circuit breakers are obsolete. Do not use on new applications. Limited service stock is available for replacement or fill purposes. Contact the nearest sales office for product availability.

Table 11.68: E Frame—100 A, Thermal Magnetic (480Y/277 Vac)

Amp Rating	1P 277 Vac—14 kA 120 Vac—65 kA				2P 480Y/277 Vac—14 kA 120/240 Vac—65 kA		3P 480Y/277 Vac—14 kA 240 Vac—65 kA		Wire Size (AWG)		Wire Temp.
	Plug-On		Bolt-On		Bolt-On		Bolt-On		Al	Cu	
	Cat. No.	Availability	Cat. No.	Availability	Cat. No.	Availability	Cat. No.	Availability			
		Requires 1 Space		Requires 1 Space		Requires 2 Spaces		Requires 3 Spaces			
EH/EHB Circuit Breakers											
15 A	Not Available	Not Available	EHB14015 [36]	—	EHB24015	—	EHB34015	—	—	(2) 14–10	60/75 °C
	—	—	—	—	—	—	EHB340151042	—	—	(2) 14–10	60/75 °C
	—	—	EHB140151082	—	—	—	EHB340151082	—	—	(2) 14–10	60/75 °C
20 A	Not Available	Not Available	EHB14020 [36]	—	Not Available	Not Available	EHB34020	—	—	(2) 14–10	60/75 °C
	—	—	—	—	—	—	EHB340201042	—	—	(2) 14–10	60/75 °C
	—	—	Not Available	Not Available	Not Available	Not Available	EHB340201082	—	—	(2) 14–10	60/75 °C
25 A	—	—	—	—	Not Available	Not Available	EHB340201212	—	—	(2) 14–10	60/75 °C
	Not Available	Not Available	Not Available	Not Available	Not Available	Not Available	Not Available	Not Available	12–8	14–8	60/75 °C
	Not Available	Not Available	Not Available	Not Available	Not Available	Not Available	EHB34030	—	12–8	14–8	60/75 °C
30 A	—	—	EHB140301082	—	EHB240301042	—	EHB340301082	—	12–8	14–8	60/75 °C
	—	—	—	—	EHB240301082	—	EHB340301212	—	12–8	14–8	60/75 °C
	—	—	—	—	—	—	EHB3403035	—	12–8	14–8	60/75 °C
35 A	Not Available	Not Available	Not Available	Not Available	Not Available	Not Available	EHB34035	—	12–2	14–2	75 °C
	Not Available	Not Available	Not Available	Not Available	Not Available	Not Available	Not Available	Not Available	12–2	14–2	75 °C
40 A	—	—	—	—	—	—	Not Available	Not Available	12–2	14–2	75 °C
	—	—	—	—	—	—	EHB340401212	—	12–2	14–2	75 °C
45 A	Not Available	Not Available	Not Available	Not Available	Not Available	Not Available	Not Available	Not Available	12–2	14–2	75 °C
	Not Available	Not Available	Not Available	Not Available	EHB24050	—	Not Available	Not Available	12–2	14–2	75 °C
50 A	—	—	—	—	—	—	EHB340501042	—	12–2	14–2	75 °C

[35] Contact the nearest sales office for availability.

[36] UL Listed as SWD (switching duty) rated.



by Schneider Electric

EH/EHB Circuit Breakers
Class 590, 652

Obsolescent Circuit Breakers

schneider-electric.us

Table 11.68 E Frame—100 A, Thermal Magnetic (480Y/277 Vac) (cont'd.)

Amp Rating	1P 277 Vac—14 kA 120 Vac—65 kA				2P 480Y/277 Vac—14 kA 120/240 Vac—65 kA		3P 480Y/277 Vac—14 kA 240 Vac—65 kA		Wire Size (AWG)		Wire Temp.
	Plug-On		Bolt-On		Bolt-On		Bolt-On		Al	Cu	
	Cat. No.	Availability	Cat. No.	Availability	Cat. No.	Availability	Cat. No.	Availability			
60 A	—	—	—	—	—	—	EHB340501082	—	12–2	14–2	75 °C
	—	—	—	—	—	—	Not Available	Not Available	12–2	14–2	75 °C
	Not Available	Not Available	Not Available	Not Available	EHB24060	—	Not Available	Not Available	12–2	14–2	75 °C
	—	—	—	—	—	—	Not Available	Not Available	12–2	14–2	75 °C
	—	—	—	—	—	—	Not Available	Not Available	12–2	14–2	75 °C
70 A	—	—	—	—	Not Available	Not Available	Not Available	Not Available	4–2/0	4–2/0	75 °C
80 A	—	—	—	—	Not Available	Not Available	Not Available	Not Available	4–2/0	4–2/0	75 °C
90 A	—	—	—	—	Not Available	Not Available	Not Available	Not Available	4–2/0	4–2/0	75 °C
100 A	—	—	—	—	EHB24100 [37]	—	Not Available	Not Available	4–2/0	4–2/0	75 °C
100 A	—	—	—	—	EHB24100 1082	—	Not Available	Not Available	4–2/0	4–2/0	75 °C
EH/EHB HID Circuit Breakers — For Use on High Intensity Discharge Lighting Systems											
15 A	Not Available	Not Available	Not Available	Not Available	EHB24015HID	—	Not Available	Not Available	—	(2) 14–10	60/75 °C
20 A	Not Available	Not Available	EHB14020HID [38]	—	Not Available	Not Available	EHB34020HID	—	—	(2) 14–10	60/75 °C
25 A	Not Available	Not Available	Not Available	Not Available	Not Available	Not Available	Not Available	Not Available	12–8	14–8	60/75 °C
30 A	Not Available	Not Available	Not Available	Not Available	Not Available	Not Available	EHB34030HID	—	12–8	14–8	60/75 °C

[37] For use only in Series 3 or Series E1 panelboards. Contact the nearest sales office for use in earlier series panelboards

[38] UL Listed as SWD (switching duty) rated.

FJA Circuit Breakers

NOTE: FJ 3-pole circuit breakers are obsolete. Please refer to Digest Section 7 for PowerPact™ molded case circuit breakers for new installations or replacement.

Table 11.69: Mechanical Lug Kit Information

Circuit Breaker Application				Number of Wires Per Lug and Wire Range	Kit Cat. No.	Lugs Per Kit
Standard	Ampere Rating	Optional	Ampere Rating			
Al Lugs for Use with Al or Cu Wire						
FJ	35–125 A	FJ	15–30 A	(1) 12–2/0 AWG Al or (1) 14–2/0 AWG Cu	AL100FD	3

Table 11.70: Handle Accessories

Circuit Breaker Type	No. of Poles	Cat. No.
Handle Padlock Attachment (locks ON or OFF)		
FJ	1, 2 or 3	HPAFD

QE Metering Circuit Breakers

NOTE: QE circuit breakers are obsolete. Please refer to Digest for PowerPact™ molded case circuit breakers for new installations or replacement.

Table 11.71: Branch Circuit Breakers

System Type	Branch Device		
	Ampere Rating	Cat. No.	Availability
1Ø IN – 1Ø OUT or 3Ø IN – 1Ø3W OUT			
200 A Max.	70 A	QE270VH	—
	80 A	QE280VH	—
	90 A	QE290VH	—
	100 A	QE2100VH	—
	125 A	QE2125VH	Not Available
	150 A	QE2150VH	—
	175 A	QE2175VH	Not Available
3Ø IN 3Ø OUT	200 A	QE2200VH	Not Available
	70 A	QE370VH	—
	80 A	QE380VH	Not Available
	90 A	QE390VH	Not Available
	100 A	QE3100VH	Not Available
	125 A	QE3125VH	Not Available
	150 A	QE3150VH	Not Available
200 A Max.	175 A	QE3175VH	Not Available
	200 A	QE3200VH	Not Available



KDL and KGL
3P Circuit Breaker
100–250 A

KD/KG Circuit Breakers

NOTE: KD and KG circuit breakers are obsolete. Please refer to Digest Section 7 for PowerPact™ molded case circuit breakers for new installations or replacement.

Table 11.72: Handle Accessories

Circuit Breaker Type	Cat. No.	Availability
Handle Padlock Attachment (locks ON or OFF)		
KDL, KGL	HPAKD	Not Available

Table 11.73: Interrupting Ratings (kA)

Circuit Breaker Type	Voltage	Interrupting Rating
KDL	240 V	25 kA

Table 11.74: PowerPact™ K Frame—250 A, Thermal-Magnetic (240 Vac)

Continuous Current Rating @ 40° C	AC Magnetic Trip Settings		D Interrupting Level		G Interrupting Level		Terminal Wire Range
	Hold	Trip	Cat. No.	Availability	Cat. No.	Availability	
2P, 240 Vac							
100 A	1100 A	1700 A	KDL22100	Not Available	KGL22100	Not Available	AL250KD 6 AWG–350 kcmil Al or Cu
110 A	1100 A	1700 A	KDL22110	Not Available	KGL22110	Not Available	
125 A	1100 A	1700 A	KDL22125	Not Available	KGL22125	Not Available	
150 A	1100 A	1700 A	KDL22150	Not Available	KGL22150	Not Available	
175 A	1400 A	2400 A	KDL22175	Not Available	KGL22175	Not Available	
200 A	1400 A	2400 A	KDL22200	Not Available	KGL22200	Not Available	
225 A	1400 A	2400 A	KDL22225	Not Available	KGL22225	Not Available	
250 A	1400 A	2400 A	KDL22250	Not Available	KGL22250	Not Available	
3P, 240 Vac							
100 A	1100 A	1700 A	KDL32100	—	KGL32100	Not Available	AL250KD 6 AWG–350 kcmil Al or Cu
110 A	1100 A	1700 A	KDL32110	Not Available	KGL32110	Not Available	
125 A	1100 A	1700 A	KDL32125	—	KGL32125	Not Available	
150 A	1100 A	1700 A	KDL32150	—	KGL32150	Not Available	
175 A	1400 A	2400 A	KDL32175	Not Available	KGL32175	Not Available	
200 A	1400 A	2400 A	KDL32200	Not Available	KGL32200	Not Available	
225 A	1400 A	2400 A	KDL32225	—	KGL32225	Not Available	
250 A	1400 A	2400 A	KDL32250	Not Available	KGL32250	Not Available	

Table 11.75: Mechanical Lug Kit Information

Kit Catalog Number	Circuit Breaker Application				Number of Wires Per Lug and Wire Range	Torque	Lugs Per Kit	Availability
	Standard	Ampere Rating	Optional	Ampere Rating				
Al Lugs for Use with Al or Cu Wire								
AL250KD	KDL, KGL	100–250 A	—	—	(1) 6 AWG–350 kcmil	300 lb-in (34 N•m)	3	Not Available
Cu Lugs for Use with Cu Wire Only								
CU250KD	—	—	KDL, KGL	100–250	(1) 6 AWG–350 kcmil	300 lb-in (34 N•m)	3	—

11 OBSOLESCENT AND OBSOLETE CIRCUIT BREAKERS

NHL Circuit Breakers

NOTE: NHL circuit breakers and related accessory products are obsolete. Please refer to Digest Section 7 for PowerPact™ molded case circuit breakers for new installations or replacement.

NHL Circuit Breaker
800–1200 A



Table 11.76: NHL Circuit Breaker (1200 A, 480 Vac)

Ampere Rating	AC Magnetic Trip Settings Amperes		Cat. No.		Standard Lug Kit Wire Range
	Low	High	2P	3P	
800 A	4000 A	8000 A	—	NHF368001021	AL1200NA (4) 350–750-kcmil
1000 A	5000 A	10000 A	—	NHF3610001021	
1200 A	5000 A	10000 A	—	NHF361200	
1200 A	5000 A	10000 A	—	NHF3612001021	
800 A	4000 A	8000 A	—	NHL36800	
1000 A	5000 A	10000 A	NHL261000	NHL361000	
1000 A	5000 A	10000 A	—	NHL3610001021	
1200 A	5000 A	10000 A	NHL261200	NHL361200	
1200 A	5000 A	10000 A	—	NHL3612001021	
1200 A	5000 A	10000 A	—	NHL3612001021	

Kit Cat. No.	Circuit Breaker	Ampere Rating	Number of Wires Per Lug and Wire Range [39]	Lugs Per Kit
AL1200NA	NH	600–1200	(4) 350–750 kcmil	1

Kit Cat. No.	Circuit Breaker	Number of Lugs Per Terminal and Wire Range [39]	Lugs Per Kit
VC1200NA5	NH	(1) 2/0 AWG–500 kcmil	1
VC1200NA7	NH	(1) 500–750 kcmil Al or 500 kcmil Cu	1

Cat. No.	Circuit Breaker	Description	No. of Poles
HPANA [40]	NH	Handle Padlock Attachment	2, 3
NAHEX	NH	Handle Extension	2, 3

Cat. No.	Standard Package Quantity
AL1200NAT	1

11 OBSOLETE AND OBSOLETE CIRCUIT BREAKERS

[39] Unless otherwise specified, wire sizes apply to both aluminum and copper conductors.
[40] Use with NAHEX handle extension.



M-Frame Thermal-Magnetic Circuit Breakers

NOTE: M-frame thermal-magnetic circuit breakers are obsolete. Please refer to Digest for PowerPact™ molded case circuit breakers for new installations or replacement.

Table 11.77: M-Frame—Thermal-Magnetic, Individually-Mounted Circuit Breakers, 600 Vac

Ampere Rating	AC Magnetic Trip Settings [1]		Standard Interrupting		High Interrupting		Terminal Wire Range
	Low	High	Cat. No.	Availability	Cat. No.	Availability	
2P, 600 Vac, 250 Vdc							
300 A	1500 A	3000 A	MAL26300	Not Available	MHL26300	Not Available	AL900MA (3) 3/0 AWG–500 kcmil
350 A	1750 A	3500 A	MAL26350	Not Available	MHL26350	Not Available	
400 A	2000 A	4000 A	MAL26400	Not Available	MHL26400	Not Available	
450 A	2250 A	4500 A	MAL26450	Not Available	MHL26450	Not Available	
500 A	2500 A	5000 A	MAL26500	Not Available	MHL26500	—	
600 A	3000 A	6000 A	MAL26600	Not Available	MHL26600	Not Available	
700 A	3500 A	7000 A	MAL26700	Not Available	MHL26700	—	
800 A	4000 A	8000 A	MAL26800	Not Available	MHL26800	Not Available	
900 A	4500 A	9000 A	MAL26900	Not Available	MHL26900	Not Available	
1000 A	5000 A	10000 A	MAL261000	Not Available	MHL261000	Not Available	
1200 A	5000 A	10000 A	MAL261200	Not Available	MHL261200	Not Available	AL1000MA [2] (4) 1/0 AWG–350 kcmil
3P, 600 Vac, 250 Vdc							
300 A	1500 A	3000 A	MAL36300	Not Available	MHL36300	Not Available	AL900MA (3) 3/0 AWG–500 kcmil
350 A	1750 A	3500 A	MAL36350	Not Available	MHL36350	Not Available	
400 A	2000 A	4000 A	MAL36400	Not Available	MHL36400	—	
450 A	2250 A	4500 A	MAL36450	Not Available	MHL36450	Not Available	
500 A	2500 A	5000 A	MAL36500	Not Available	MHL36500	—	
600 A	3000 A	6000 A	MAL36600	Not Available	MHL36600	—	
700 A	3500 A	7000 A	MAL36700	Not Available	MHL36700	—	
800 A	4000 A	8000 A	MAL36800	Not Available	MHL36800	—	
900 A	4500 A	9000 A	MAL36900	Not Available	MHL36900	Not Available	
1000 A	5000 A	10000 A	MAL361000	Not Available	MHL361000	Not Available	
1200 A	5000 A	10000 A	MAL361200	Not Available	MHL361200	Not Available	AL1000MA [2] (4) 1/0 AWG–350 kcmil

Table 11.78: M-Frame—Thermal-Magnetic, I-Line™ Construction Circuit Breakers, 600 Vac

Ampere Rating	AC Magnetic Trip Settings [1]		Standard Interrupting		High Interrupting		Terminal Wire Range
	Low	High	Cat. No.	Availability	Cat. No.	Availability	
2P, 600 Vac, 250 Vdc [3]							
300 A	1500 A	3000 A	MA26300()	Not Available	MH26300()	Not Available	AL900MA (3) 3/0 AWG–500 kcmil
350 A	1750 A	3500 A	MA26350()	Not Available	MH26350()	Not Available	
400 A	2000 A	4000 A	MA26400()	Not Available	MH26400()	Not Available	
450 A	2250 A	4500 A	MA26450()	Not Available	MH26450()	Not Available	
500 A	2500 A	5000 A	MA26500()	Not Available	MH26500()	Not Available	
600 A	3000 A	6000 A	MA26600()	Not Available	MH26600()	Not Available	
700 A	3500 A	7000 A	MA26700()	Not Available	MH26700()	Not Available	
800 A	4000 A	8000 A	MA26800()	Not Available	MH26800()	Not Available	
3P, 600 Vac, 250 Vdc							
300 A	1500 A	3000 A	MA36300	Not Available	MH36300	Not Available	AL900MA (3) 3/0 AWG–500 kcmil
350 A	1750 A	3500 A	MA36350	Not Available	MH36350	Not Available	
400 A	2000 A	4000 A	MA36400	Not Available	MH36400	—	
450 A	2250 A	4500 A	MA36450	Not Available	MH36450	Not Available	
500 A	2500 A	5000 A	MA36500	—	MH36500	—	
600 A	3000 A	6000 A	MA36600	Not Available	MH36600	Not Available	
700 A	3500 A	7000 A	MA36700	—	MH36700	—	
800 A	4000 A	8000 A	MA36800	—	MH36800	Not Available	

Table 11.79: Interrupting Ratings

Voltage	MA/MAL	MH/MHL
240 Vac	42 kA	65 kA
480 Vac	30 kA	65 kA
600 Vac	22 kA	25 kA

Table 11.80: Phase Options

Phase Option Letter	2P	3P
AB	MA26800AB	—
AC	MA26800AC	
BC	MA26800BC	
ABC CBA	—	MA36800 MA36800CBA

Accessories see page 11-37

Optional Lugs see page 3-25

Dimensions see page 3-28

Enclosures: see Digest Section 7




[1] UL magnetic trip setting tolerances are ±25% for low and ±20% for high from nominal values shown.

[2] The AL100MA lug is the only lug available for the 1200 A MA and MH circuit breakers.

[3] 2P circuit breaker catalog numbers are completed by adding required phase connection letters as suffix to catalog numbers. See Phase Options table.

D-Frame Electrical Accessories

Table 11.81: D-Frame Electrical Accessories

Accessory	Description	Rated Voltage	D-Frame					
			Factory-Installed Cat. Suffix	Field-Installable Cat. No.				
 <p>Auxiliary and Alarm Switches (OF, SD, SDE) G-Frame</p>	<p>Provides circuit breaker contact status. Note: The location of the accessory in the circuit breaker determines its function.</p>	Standard Min Load = 10mA with 24 V	1 auxiliary switch (OF) 1a1b	AA	S29450			
			2 auxiliary switch (OF) 2a2b	AB	2x S29450			
			3 auxiliary switch (OF) 3a3b	AC	3x S29450			
			Alarm Switch (SD) 1a1b	AD	S29450			
			Overcurrent trip switch (SDE) 1a1b	BD	S29450			
			Alarm switch and Overcurrent trip switch	BE	2x S29450			
		Low Level Min Load = 1mA with 24 V	One auxiliary switch (OF) 1a1b	AE	S29452			
			Two auxiliary switches (OF) 2a2b	AF	2x S29452			
			3 auxiliary switches (OF) 3a3b	AG	3x S29452			
			Alarm Switch (SD) 1a1b	BH	S29452			
			Overcurrent trip switch (SDE) 1a1b	BJ	S29452			
			Alarm switch and Overcurrent trip switch	BK	2x S29452			
			 <p>Shunt Trip (MX) G-Frame</p>	<p>Trips the circuit breaker from a remote location by means of a trip coil energized from a separate supply voltage circuit.</p>	AC	24	SK	S29384
48	SL	S29385						
110/130	SA	S29386						
208/277	SD	S29387						
380/480	SH	S29388						
525/600	SJ	S29389						
DC	12	SN			S29382			
	24	SO			S29390			
	30	SU			S29391			
	48	SP			S29392			
	60	SV			S29393			
	125	SR			S29393			
	250	SS			S29394			
	 <p>Undervoltage Trip G-Frame</p>	<p>Instantaneously opens the circuit breaker when the under-voltage trip supply voltage drops to a value between 35% and 70% of its rated voltage. Closing is allowed when the supply voltage of the undervoltage trip reaches 85% of rated voltage.</p>			AC	24	UK	S29404
						48	UL	S29405
						110/130	UA	S29406
						208/277	UD	S29407
						380/480	UH	S29408
525/600			UJ	S29409				
DC			12	UN	S29402			
			24	UO	S29410			
			30	UU	S29411			
			48	UP	S29412			
			60	UV	S29403			
			125	UR	S29413			
250	US	S29414						

11 OBSOLETE AND OBSOLETE CIRCUIT BREAKERS

11

PowerPact D-Frame Miscellaneous Accessories

Table 11.82: Bus Bar Connections Hardware for D-Frame Circuit Breakers

Frame	Description	Term. No.	Poles	Cat. No.
D-Frame	Set of 3 terminal screws and washers for one side	F	3	36966
	Set of 4 terminal screws and washers for one side		4	36967

Table 11.83: Terminal Shields and Phase Barriers

Used With	Description			Dimension B (in.)	Cat. No.	Qty Per Kit
D-Frame	Terminal Shield (3P)	PDC5DG2	—	—	36965	1

Table 11.84: Miscellaneous D-Frame Circuit Breaker Accessories

Accessory	Description	Field-Installed Cat. No.
External Neutral Sensor	150 A Neutral Sensor	36950
	250 A Neutral Sensor	36951
	400 A Neutral Sensor	36952
	600 A Neutral Sensor	36953
Spare Parts	100 Identification Labels	29314
Test Kits	Mini test kit (battery not included)	43362
	Portable test kit	55391

Table 11.85: Motor Operators for D-Frame Circuit Breakers

Description	Rated Voltage	Factory Installed Cat. No. Suffix	Field-Installed Cat. No.
Standard motor for electrically-operated circuit breakers	AC	48/60	ML 32839
		110/130	MA 32840
		208/277	MD 22841
		220/240	MC —
		380/415	MF 32842
		380/485	MH —
	DC	440/480	MH 32847
		24/30	MO 32843
		48/60	MP 32844
		110/130	MR 32845
Locking Device	Mounting Hardware	—	32649
		Ronis lock	41940
		Profalux lock	42888
Operations Counter	—	—	32648



Mini Test Kit



Portable Test Kit



Motor Operator

Locks, Installation Accessories, and Rear Connections

Table 11.86: Locks, Interlocking

Device	Description	D-Frame Field-Installable Cat. No.
Handle Padlocking Device	Removable (lock OFF only)	S29370
	Fixed (lock OFF or ON)	S32631
	Fixed (lock OFF only)	NJPAF
Interlocking (Not UL listed)	Mechanical for circuit breakers with rotary handles	32621
	Mechanical for circuit breakers with toggles	32614
Key Locking	Ronis	41950
	Profalux	42878

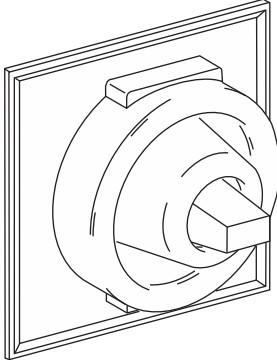
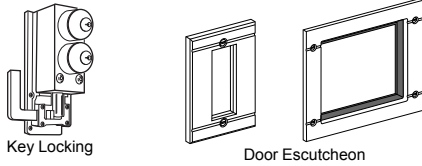
Provision and 2 locks keyed alike

Table 11.87: Installation Accessories for G- and D-Frame Circuit Breakers

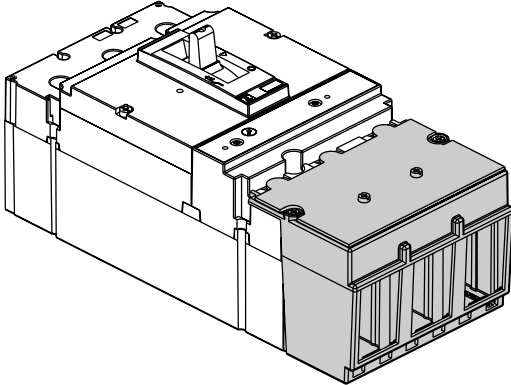
Description	D-Frame Field-Installable Cat. No.
Front Panel Escutcheon for Toggle Breakers	32556
Front Panel Escutcheon for Rotary Handle, Motor Operator, or extended escutcheon	32558
Phase Barriers (set of 6)	32570
Handle Rubber Boot	32560
Sealing Accessories	29375
DIN rail adapter	—
Toggle Extensions (set of 10)	32553

Table 11.88: Rear Connections

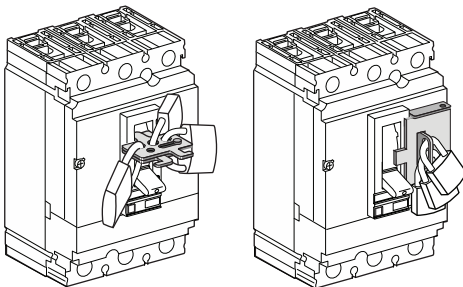
Device	Poles	D-Frame		
		Factory-Installed Termination No.	Field-Installed Cat. No.	
Mixed Rear Connection Kit	3	S	32477	
	4	S	32478	
Consisting of:	Short rear connections (set of 2)	3	—	2x 32475
	Long rear connections (set of 2)	3	—	32476
	Short terminal cover (3P)	3	—	32562



Hard Rubber Boot



Terminal Covers



Removable Padlock Attachment Fixed Padlock Attachment

Neutral Current Transformers and Micrologic Series B Trip Unit Accessories

Table 11.89: Neutral Current Transformers

Cat. No.	Sensor	Where Used
LE25CT2	250 A	LXL, LEL, LXIL
LE4CT2	400 A	
LE6CT2	600 A	

Table 11.90: Electronic Trip Indicator and Current Meter Field-installable Kits

Device	Cat. No.	Included With Circuit Breaker	Optional
Local Trip Indicator Kit	ALTI	—	LXL, LXIL
Local Current Meter Kit/Trip Indicator	ALAM	LEL	LXL, LXIL

Table 11.91: Interchangeable Rating Plug Kits for all Circuit Breakers with Micrologic Series B Trip System

Cat. No.	Sensor Multiplier Value
ARP040	0.400
ARP050	0.500
ARP056	0.563
ARP058	0.583
ARP060	0.600
ARP063	0.625
ARP067	0.667
ARP070	0.700
ARP075	0.750
ARP080	0.800
ARP083	0.833
ARP088	0.875
ARP090	0.900
ARP100	1.000



Combination Load Current Meter and Trip Indicator



Electronic Trip Unit with Seals Installed to Restrict Access



CIM3F Communication Adapter



Universal Test Set

Complying with the NEC®

The National Electrical Code, Section 240–6(c) exception allows conductors ampere ratings equal to the selected long-time pickup setting. Square D offers the seals below to restrict access to the trip unit once settings are selected.

Table 11.92: Trip Unit Seals

Description	Cat. No.	Package Quantity
Trip Unit Seal	TUSEAL	100

Table 11.93: Communication Adapter

Description	Cat. No.
Communication Adapter	CIM3F [1]

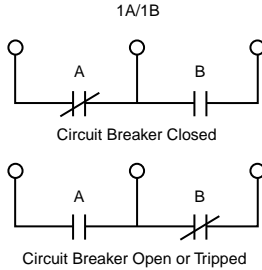
Table 11.94: Test Equipment for Circuit Breakers with Micrologic Series B Trip Systems

Description	Cat. No.
Universal Test Set (includes test module for Full-function and Standard-function LEL, LXL, LXIL)	UTS3
Test Module for Full-function and Standard-function LEL, LXL, LXIL. (For use with existing CBTU1 or UTS3 test set.)	CBTMB
Replacement ribbon cable and rating plug adapter for CBTMB	CBTMBRK
Long-time and ground-fault Memory Reset Module (Series B Electronics)	MTMB

[1] Required for Micrologic to communicate with PowerLogic™ system.

Auxiliary Switch Contact Configuration

Color Code:
"A" Contact - Yellow Leads
"B" Contact - Blue Leads
Common-Striped Leads



1A Alarm Switch Configuration

Color Code: Red Leads

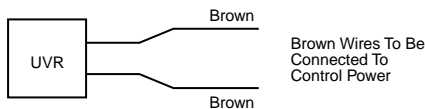


1B Alarm Switch Configuration

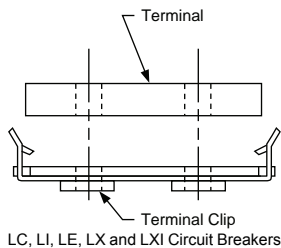
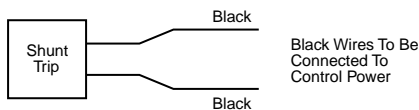
Color Code: Red Leads



Undervoltage Trip Wiring Diagram



Shunt Trip Wiring Diagram



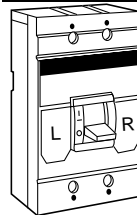
Field-Installable Electrical Accessories

Complete field-installable accessory catalog number by inserting suffix from Digest Section 7 between the parentheses in the catalog numbers shown in the table below. (Example: LA11212)

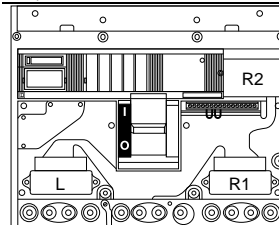
Table 11.95: Field-Installable Accessories for Thermal-Magnetic and Electronic Trip Circuit Breakers

Circuit Breaker	Shunt Trip	Ground-Fault Shunt Trip [2]	Undervoltage Trip	Auxiliary Switches	Alarm Switch
FI, KI	Factory-Installed Only	Factory-Installed Only	Factory-Installed Only	Factory-Installed Only	Factory-Installed Only
LC, LE	LC1()	LC1G	LC1 ()	LC1()	Factory-Installed Only
LI, LX, LXI	LC1()	LC1G	LC1 ()	LC1()	Factory-Installed Only
MA, MH Series 2	MA1()	MA1G	MA1 ()	MA1()	Factory-Installed Only Center Pole
ME, MX	Factory-Installed Only	Factory-Installed Only	Factory-Installed Only	Factory-Installed Only	Factory-Installed Only
NA, NC, NE, NX Series 1, 2, 3	NA1()	NA1()	NA1()	NA1()	NA1()
PA, PH, PC Series 4	PA1()	Factory-Installed Only	PA11121	PA1()	Factory-Installed Only
PE, PX Series 4, 5, 6	PA1()	Factory-Installed Only	PA11121	PA1()	Factory-Installed Only

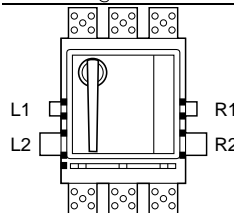
Table 11.96: Accessory Mounting Locations



MA, MH Series 2 circuit breakers or newer = Field-installable accessories
ME/MX circuit breakers = Not field-installable accessories



NA, NC, NE, NX circuit breakers - Field-installable accessories
"L" port and "R" port will accept shunt trips, alarm switches and UVRs;
"R2" port will accept auxiliary switches. Maximum of one device per port.



PA, PH, PC, PE, PX Series 4 circuit breakers or newer = Field-installable accessories.
"L1" and "L2" or "R1" and "R2" port combinations are required to mount a single shunt trip. Both "L2" and "R2" ports will accept a UVR. Both "L1" and "R1" ports will accept auxiliary switches. If alarm switch is factory installed in PA or PC circuit breaker, it will be installed in "R2" port. For a PE or PX circuit breaker, the alarm switch will be factory installed in "L2" port.

LC, LI, LE, LX and LXI Circuit Breaker Termination Clip Kit

The standard lugs supplied with LC, LI, LE, LX and LXI circuit breakers are secured by means of a screw fastened through the circuit breaker terminal into the lug body. If the standard lug is removed and a bolted connection to the circuit breaker terminal is desired, the AL600IN threaded terminal clip kit is required to make this connection. The AL600IN clip snaps onto the bottom of the terminal. For ordering information, see chart below.

Table 11.97: Termination Clip Kit

Kit Cat. No.	Clips Per Kit	Circuit Breakers
AL600IN	3	LC, LI, LE, LX, LXI

[2] Used with obsolete GP Ground-Censor™ system or add-on ground-fault modules.



KAMO2120AC
with KIL Circuit Breaker



FAMO1 and FAMOP
with FAL Circuit Breaker

Electrical Operators

Provides remote ON, OFF/RESET control of molded case circuit breakers.

- A complete line of field-installable electrical operators.
- Not applicable on LC/LI/LE/LX/LXI circuit breakers.
- Installing side mounted motor operators on non I-Line™ circuit breakers requires the use of a separate mounting pan.
- Side mounted electrical operators require an additional 4-1/2 in. (114 mm) of mounting space in I-Line installations.

When remote indication of circuit breaker status is required, order circuit breaker with 1A-1B auxilliary switch for ON-OFF Indication and alarm switch for TRIP Indication. Electrical operators require SPDT maintained contact switch. Refer to Class 9001 control unit listing for operators and pilot lights.

NOTE: Not available on Mag-Gard™ circuit breakers and molded case switches.

Table 11.98: Electrical Operators

Circuit Breaker Prefix	Top Mount		Side Mount		Mounting Pan Cat. No.
	Voltage	Cat. No.	Voltage	Cat. No.	
FI, KI	—	—	120 Vac	KAMO1	—
FIL, KIL	120 Vac	KAMO2120AC	120 Vac	KAMO1	KAMOP
	240 Vac	KAMO2240AC			
	24 Vdc	KAMO224DC			
	125 Vdc	KAMO2125DC			
MAL, MHL	120 Vac	MAMO2120AC	120 Vac	MAMO1	MAMOP
	240 Vac	MAMO2240AC			
	24 Vdc	MAMO224DC			
	125 Vdc	MAMO2125DC			
PA, PH, PC, PE, PX	120 Vac	PAMO2	—	—	—

Handle Accessories

Table 11.99: Handle Accessories

Circuit Breaker Prefix	Poles	Cat. No.
Handle Tie		
2 FI, 2 KI, or 1 FI + 1 KI	2, 3	FKHT
California Title 24 Comb. Handle Tie and Lock Off		
Handle Extension		
LE, LI, LX, LXI	2, 3	AHXL1
Handle Padlock Attachment (locks ON or OFF)		
FI	1, 2, 3	HPAFK
KI	2, 3	HPAFKF [3]
LC, LE, LI, LX, LXI	2, 3	AHPALI

[3] Locks OFF only.

Mechanical Lugs

Table 11.101: Mechanical Lug Kit Information

Circuit Breaker Application				(Number of Wires Per Lug) Wire Range [4]	Cat. No.	Lugs Per Kit	Availability
Standard	Ampere Rating	Optional	Ampere Rating				
Al Lugs for Use with Al or Cu Wire							
FI	15–30 A	FI	35–100 A	(1) 14–4 AWG Cu or (1) 12–4 AWG Al	AL50FA	3	—
FI	35–100 A	FI	15–30 A	(1) 14–1/0 AWG Cu or (1) 12–1/0 AWG Al	AL100FA	3	—
KI	110–175 A	—	—	(1) 4 AWG–350 kcmil	AL250KA	3	—
KI	200–250 A	KI	110–175 A	(1) 1/0 AWG–350 kcmil	AL250KI	3	—
LE, LX, LXI	100–250 A	LI, LE, LX, LXI	300–600 A	(2) 1 AWG–350 kcmil	AL600LI35	1	—
LI, LE, LX, LXI	300–600 A	LE, LX, LXI	100–250 A	(2) 4/0 AWG–500 kcmil	AL600LI5	1	—
—	—	LC, LI, LE, LX, LXI	—	(1) 500–750 kcmil	AL600LI7	1	—
—	—	LC, LI, LE, LX, LXI	—	(1) 500–750 kcmil	AL600LI7	1	—
MA, MH	300–1000 A	—	—	(3) 3/0 AWG–500 kcmil	AL900MA	1	—
—	—	MA, MH	300–1000 A	(2) 500–750 kcmil	AL800MA7	1	—
—	—	MA, MH	300–1200 A	(4) 1/0 AWG–350 kcmil	AL1000MA	1	—
ME, MX	100–250 A	—	—	(1) 6 AWG–350 kcmil	AL250ME	3	Not Available
—	—	ME, MX	250–400 A	(1) 350–750 kcmil	AL400ME7	1	Not Available
—	—	ME, MX	100–800 A	(2) 500–750 kcmil	AL800MA7	1	—
ME, MX	300–800 A	ME, MX	100–250 A	(3) 3/0 AWG–500 kcmil	AL900MA	1	—
—	—	ME, MX	300–1200 A	(4) 1/0 AWG–350 kcmil	AL1000MA	1	—
NA, NC, NE, NX	600–1200 A	—	—	(4) 3/0 AWG–600 kcmil	AL1200NE6	1	Not Available
—	—	PAF, PHF, PEF, PXF, PCF	600–2500 A	(1) 1/0 AWG–750 kcmil	AL2500PA	2	—
Cu Lugs for Use with Cu Wire Only [5]							
—	—	FI	15–100 A	(1) 14–1 AWG Cu	CU100FA	3	—
—	—	FI	15–100 A	(1) 14–1 AWG Cu	CU100FA	3	—
—	—	KI	110–250 A	(1) 4 AWG–250 kcmil Cu	CU250KA	3	—
—	—	LI, LE, LX, LXI	—	(2) 1 AWG–350 kcmil Cu	CU600LI35	1	—
—	—	LI, LE, LX, LXI	—	(2) 4/0 AWG–500 kcmil Cu	CU600LI5	1	—
—	—	LI, LE, LX, LXI	—	(1) 500–750 kcmil Cu	CU600LI7	1	—
—	—	MA, MH	300–1000 A	(3) 3/0 AWG–500 kcmil Cu	CU1000MA	1	—
—	—	ME, MX	125–250 A	(1) 4 AWG–250 kcmil Cu	CU250ME	3	Not Available
—	—	ME, MX	100–800 A	(3) 3/0 AWG–500 kcmil Cu	CU1000MA	1	—
—	—	NA, NC, NE, NX	600–1200 A	(4) 3/0 AWG–600 kcmil Cu	CU1200NE6	1	Not Available



AL900MA



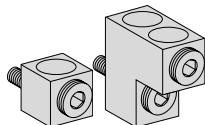
AL800MA7



AL1000MA



AL2500PA



D-Frame Lugs

Table 11.100: Terminal Shields and Phase Barriers

Used With	Description	Cat. No.	Qty Per Kit
D-Frame	Terminal Shield (3P) PDC5DG2 PDC12DG2	36965	1

Table 11.102: Mechanical Lug Kits for D-Frame Circuit Breakers

Description	Poles	Cat. No.	
		400 A Lugs	600 A Lugs
Field-Installable Lug Kit, Terminal Cover Included	3	32508	32510
Voltage Takeoffs (set of two)		29348	29348
Wire Range		(1) 2 AWG–600 kcmil stranded CU cable (1) 2 AWG–500 kcmil stranded AL cable	(2) 2/0 AWG–350 kcmil stranded CU cable (2) 2/0 AWG–500 kcmil stranded AL cable

Control Wire Tap Lugs

Control wire tap lugs are used in applications requiring connection to a small wire (22–14 AWG) for control circuits. This is accomplished by crimping the wire to a standard wire crimp terminal (not included) and fastening the terminal to the circuit breaker lug.

Note: To order as a factory-installed device on FI, KI, LC, LI, LXI, LX or LC circuit breakers, add suffix number 8041 to circuit breaker catalog number, e.g., KIL362258041.

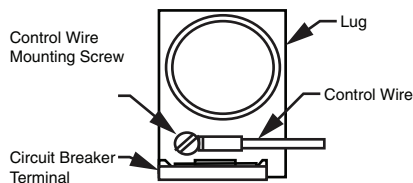


Table 11.103: Control Wire Terminations for Circuit Breakers

Circuit Breaker	Control Wire Termination Kits	
	Cat. No.	Standard Package Quantity
FI	FAT [6]	1
KI	AL250KIT	1
LC, LI, LXI, LX, LE	AL600LI35T	1
	AL600LI5T	1
	AL900MAT	1
MA, MH, MX, ME	AL1000MAT	1
	AL1200NE6T	1

[4] Unless otherwise specified, wire sizes apply to both aluminum and copper conductors.

[5] Use suffix 8002 for factory-installed Cu lugs.

[6] Use fully-insulated 0.250 inch slip-on connectors.

11

OBSOLETE AND OBSOLETE
CIRCUIT BREAKERS

Compression Lug Kits

Table 11.104: Field-installable Compression Lug Kits

Circuit Breaker Type	Wire Range [7]	Dimension A (in)	Max. Lugs Per Terminal	Cat. No. [8]	Lugs Per Kit	Availability
Aluminum Compression Lug Kits						
D-Frame	—	—	—	—	—	—
FI	8–1/0 AWG	1.3	1	VC100FA	3	—
KI	4 AWG–300 kcmil	1.5	1	VC250KA3	3	—
	250–350 kcmil	1.5	1	VC250KA35	3	—
LI, LE, LX, LXI [9]	4 AWG–300 kcmil	1.05	2	VC600LI3	2	—
	2/0 AWG–500 kcmil	3.20	2	VC600LI5	2	—
	500–750 kcmil	3.45	1	VC600LI7	1	—
MA, MH	2/0 AWG–500 kcmil	1.9	2	VC600MA5	2	Not Available
	500–750 kcmil	2.1	2	VC800MA7	2	Not Available
ME2, MX2	4 AWG–300 kcmil	1.5	1	VC250ME3	3	Not Available
	250–350 kcmil	1.5	1	VC250ME35	3	Not Available
ME4, MX4	2/0 AWG–500 kcmil	2.2	1	VC400ME5	1	Not Available
	500–750 kcmil Al or 500 kcmil Cu	2.5	1	VC400ME7	1	Not Available
ME, MX, MA, MH	2/0 AWG–500 kcmil	1.9	2	VC600MA5	2	Not Available
	500–750 kcmil Al or 500 kcmil Cu	2.1	2	VC800MA7	2	Not Available
NA, NC, NE, NX	2/0 AWG–500 kcmil	3.3	4	VC1200NE5	4	Not Available
	500–750 kcmil Al or 500 kcmil Cu	3.6	4	VC1200NE7	4	Not Available
PAF, PHF, PCF, PEF	2/0 AWG–500 kcmil	[10]	6–8	VC2000PA5	4	Not Available
	2/0 AWG–500 kcmil	[10]	6–8	VC2500PA7	4	Not Available
Copper Compression Lug Kits						
FI	6–1/0 AWG Cu	1.4	1	CVC100FA	3	—
KI	2/0 AWG–300 kcmil Cu	1.5	1	CVC250KA3	3	—
LI, LE, LX, LXI [9]	250–500 kcmil Cu	3.20	2	CVC600LI5	2	—
ME4, MX4	250–500 kcmil Cu	2.6	1	CVC400ME5	1	Not Available
ME, MX	250–500 kcmil Cu	2.4	2	CVC600MA5	2	Not Available
NA, NC, NE, NX	250–500 kcmil Cu	3.3	4	CVC1200NE5	4	Not Available
	500–750 kcmil Cu	3.6	4	CVC1200NE7	4	Not Available

Power Distribution Connectors (PDC) for Circuit Breakers—for Field Replacement of Mechanical Lugs

Can be used for multiple load connections on one circuit breaker. Use in place of standard distribution blocks to save space and time.

Field-installable kits, including tin-plated aluminum connectors and all necessary mounting hardware are available for Square D FA, LA and Q4-frame molded case circuit breakers.

Connectors are UL Listed:

- For use on load end of circuit breaker only
- For use in UL508 Industrial Control applications only
- For use in UL 1995/CSA C22.2 No. 236 heating and cooling equipment
- For copper wire only

Table 11.105: Power Distribution Connectors for D-Frame Circuit Breakers

Use with Circuit Breaker Type	Circuit Breaker Ampere Rating	Wires Per Terminal & Wire Range	Dimension A (in.)	Cat. No.	Quantity Per Kit
DG, DJ, DL	150–600	(3) 14–2 AWG and (2) 14–2/0 AWG	1.28 [11]	PDC5DG20	3
	150–600	(12) 14–4 AWG	1.31 [11]	PDC12DG4	3

Table 11.106: Power Distribution Connectors for M- and P-Frame Circuit Breakers

Use With Circuit Breaker [12]	Circuit Breaker Ampere Rating	Wires Per Terminal & Wire Range [13] Cu	Cat. No.	Lug Quantity Per Kit	Dimension A (in.)	Availability
MAL, MHL, MEL, MXL	125–1000 A	(6) 12–2/0 AWG Cu	PDC6MA20	1	0.0	Not Available
		(12) 14–4 AWG Cu	PDC12MA4	1	0.0	Not Available

[7] Unless otherwise specified, wire sizes apply to both aluminum and copper conductors.
 [8] See instruction bulletins for recommended tools.
 [9] These lug kits cannot be used on I-Line™ circuit breakers.
 [10] All P-frame circuit breakers require terminal pads for mounting lugs of any type.
 [11] Kit includes long terminal shield, which adds 1.65 inches to standard lug with short terminal shield.
 [12] Not for use with I-Line circuit breakers.
 [13] When using fine stranded wire, increased cross sectional area may cause maximum wire size to be reduced.

Test Information

NOTE: Listed below are the catalog numbers and the components required for testing the entire family of Micrologic trip systems. The listing includes obsolete series trip systems.

Identified by a label on the front of the trip unit:

- LE/LX/LXI, ME/MX, NE/NX and PE/PX circuit breaker 9/92 to present
- SE circuit breaker 10/92 to present

This is the latest series of standard (LX/LXI, MX, NX and PX) and full-function (LE, ME, NE, PE and SE) Micrologic trip systems.



Table 11.107: Universal Test Set

Description	Cat. No.
Universal Test Set includes the following: 1. Self-test module (CBTM1) 2. Standard and full-function Micrologic Series B module (CBTMB) includes rating plug adapter 3. Power cord 4. Ribbon cable for making the connection from the test set to the rating plug adapter 5. Instruction manual	UTS3
For those customers who already own the Universal Test Set and want to test the latest standard and full-function (Series B) trip systems, all that is needed is the Micrologic Series B module (CBTMB). Included is the rating plug adapter and instruction manual.	CBTMB
Replacement ribbon cable and rating plug adapter for CBTMB	CBTMBRK
Long-time and ground-fault memory reset module (Series B Electronics)	MTMB

Identified by two rows of rotary switches
(ME/MX, NE/NX and PE/PX circuit breakers 11/89 to 9/92)
(SE circuit breakers 5/90 to 10/92)

For those customers who already own the Universal Test Set (CBTU1 or UTS3) and want to test these earlier series Micrologic trip systems, see the following chart.

Table 11.108: Micrologic Series 3 and Series A Circuit Breaker Test Module

Circuit Breaker Test Module	Cat. No.
Includes rating plug adapter and instruction manual	CBTM4A
Replacement ribbon cable and rating plug adapter for CBTM4A	CBTM4RK

Identified by only one row of rotary switches

Micrologic Series 2 Test Modules are obsolete and no longer available.

Table 11.109: Micrologic Series 2 Circuit Breaker Test Module

Circuit Breaker Test Modules	Cat. No.	Availability
Replacement ribbon cable and rating plug for CBTM1	CBTM1A	Not Available
ME, PE (4/85-11/89) CBTM2 obsolete, no longer available	CBTM2	Not Available
ME, NE, PE (10/86-11/89) includes rating plug adapter and instruction manual	CBTM3	Not Available
Replacement ribbon cable and rating plug for CBTM3	CBTM3A	Not Available

Table 11.110: Micrologic Series 1 Trip Systems for Circuit Breakers Manufactured Before Micrologic

Trip System	Test Set
ME/PE (8/78-4/85) Identified by slide type switches instead of rotary switches. The very first series ME and PE electronic trip circuit breakers offered by Square D.	Test Set Not Available

NOTE: For trip systems of this type that require testing, contact Technical Services toll free at 1-800-634-2003.

Table 11.111: Neutral Current Transformers

Cat. No.	Availability	Sensor	Where Used
ME25CT2	Not Available	250 A	
ME4CT2	Not Available	400 A	MXL, MEL
ME8CT2	Not Available	800 A	
NE12CT2	—	1200 A	NXL, NEL
PE12CT2	Not Available	1200 A	
PE16CT2	Not Available	1600 A	PXF, PEF
PE20CT2	Not Available	2000 A	
PE12CT2	Not Available	2500 A	



GFM250

GFM Ground Fault Module

The Micrologic ground-fault module (GFM) is a UL Listed circuit breaker accessory for equipment protection. It is a combination ground-fault relay and ground-fault sensing device.

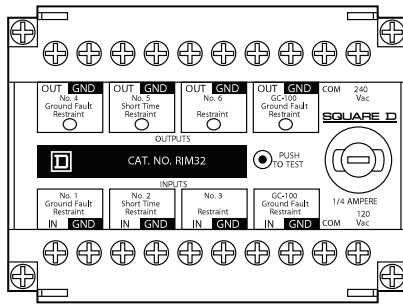
Micrologic Add-On Ground-Fault Module features:

- Used in combination with the FA, KA, FC, KC, FI, and KI type circuit breakers with a ground-fault shunt trip factory installed (add the suffix "G" to the circuit breaker)
- Adjustable ground-fault pickup levels
- Adjustable ground-fault time delays
- Integral ground fault push-to-test feature and ground-fault indicator
- All GFMs supplied for I-Line™ mounting, easily convertible to unit mount by removing the I-Line brackets
- Neutral current transformer is supplied for 3-phase 4-wire applications. Refer to instructions for proper installation
- Zone-selective interlocking capability is standard with upstream Micrologic trip system circuit breakers. The GFM can also be zone interlocked with the GC ground-fault system by using a restraint interface module. See page 11-43.
- 120 Vac control power is required for integral test feature. Meets NEC 230-95(c)

NOTE: Ground-fault modules cannot be reverse fed.

Table 11.112: Module/Enclosure Selection Chart

Companion Circuit Breaker Prefix	Cat. No.	Enclosure Space Required		Ground-Fault Pickup Adjustment Range	Availability
		I-Line Switchboard	Individual Enclosure [1]		
FAL, FHL, FCL, FA, FH, FC	GFM100FA	LA	KA	20–100 A	—
FI	GFM100FI	LA	—	20–100 A	Not Available
KAL, KHL, KI, KA, KH, KC	GFM250	LA	LA	40–200 A	—



RIM32

Table 11.113: RIM32

Cat. No.
RIM32

RIM32 Restraint Interface Module

The RIM32 Restraint Interface Module is used to interface the restraint signals between various Square D Micrologic™ circuit breakers, Micrologic ground-fault modules, and GC-100 ground-fault protection systems.

The restraint interface module operates on either 120 or 240 Vac, 50/60 Hz. The module is protected by a 1/4 A fuse.

Allowable ZSI combinations are shown in the table below. (Series numbers for current design circuit breakers end in B, for example NE Series 3B.) For double-ended or larger systems, or systems which contain devices from different columns in the table below, contact your local Sales Office for combination information.

If more inputs or outputs are needed, another restraint interface module is necessary. Contact your local Sales Office for information on multiple module installations.

NOTE: The maximum distance between devices is 1000 ft. (305 m).

Table 11.114: ZSI Combination (Where All Inputs Driven are Same Columns)

Circuit Breaker Series Outputs	Circuit Breaker Series Inputs							Rim32
	SE 2 (Ground Fault)	SE 2 (Short Time)	ME 3, NE 1, PE 4	ME 4 & 5, NE 2 & 3, P 5 & 6A, SE 3A	ME 5A, NE 3A, PE 6A, SE 3A	LE 1B, ME 5B, NE 3B, PE 6B, SE 3B	GC100	
SE 2 (Ground Fault)	50	—	R	R	R	R	R	50
SE 2 (Short Time)	—	1	R	R	R	R	R	50
ME 3, NE 1, PE 4	50	R	15	2	13	47	R	50
ME 4, 5 & 5A, NE 2, 3 & 3A, PE 5, 6 & 6A, SE 3 & 3A	50	R	R	1	1	7	R	14
LE 1B, ME 5B, NE 3B, PE 6B, SE 3B	50	R	10	1	R	26	R	44
GC100	R	R	R	R	R	R	R	7
GFM [2]	50	—	2	1	1	5	R	1
RIM32	50	6	50	7	37	50	15	50

= Maximum inputs without RIM32. Self-restraint counts as one input.
R =RIM32(s) required to restrain any device.
— = Invalid combination.

[1] Use NEMA 1 or 3R enclosures only.
[2] GFM is an output device only.

To order

NOTE: Masterpact M/MP/MC circuit breakers and related accessories are obsolete. Use Masterpact NT/NW for new applications. See Digest Section 7. Limited service stock is available for replacement or fill purposes. Contact the nearest sales office for product availability.

To order a complete circuit breaker, order:

- Circuit breaker fixed or drawout frame..... order from table below.
 or circuit breaker without cradle.....order from table below.
- Connections.....page 11-48
- Control unit.....page 11-45
- Rating plug.....page 11-45
- Accessories.....page 11-46

Fixed and drawout circuit breakers listed below are complete with the STR58U Trip Unit which includes long time, short time, instantaneous and ground fault as well as options T (residual) and I (ammeter).

Table 11.115: UL Listed Masterpact MP High Interrupting (H2) Circuit Breaker Frame

		Rating	AIR 480 V	Fixed 3P	Drawout without Cradle 3P	Cradle Only 3P
MP16 to MP30— UL 489/NEMA AB1 Standards	MP16H2	1600 A	100 kA	MP100135	MP100136	MP100141
	MP20H2	2000 A	100 kA	MP100137	MP100138	MP100133
	MP30H2	3000 A	100 kA	MP100139	MP100140	MP100132

- Additional information: Catalog **0631CT9501**, Data Sheet **0631HO9701**

Masterpact™ M/MP/MC Circuit Breaker Control Units

NOTE: Masterpact M/MP/MC circuit breakers and related accessories are obsolete. Use Masterpact NT/NW for new applications. See Digest Section 7. Limited service stock is available for replacement or fill purposes. Contact the nearest sales office for product availability.

Table 11.116: Control Units

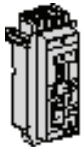
Control Unit	Ground-Fault Protection [1]	Without Ground-Fault Protection [1]	
	STR 58U (long-time, short-time and instantaneous protection)		
	STR58U (long-time = 0.4x1 sensor rating)	Includes Residual Type T — and Ammeter — I	
		External neutral sensor (TCE) [2]— see page 11-46	
		M1008H2	M1008H2NG
		M10H2	M10H2NG
		M1612H2	M1612H2NG
		M16H2	M16H2NG
		M20H2	M20H2NG
		M25H2	M25H2NG
		M3230H2	M3230H2NG
		M32H2	M32H2NG
		M6340H2	M6340H2NG
		M6350H2	M6350H2NG
	M63H2	M63H2NG	

Table 11.117: Rating Plug (RL)

Sensor Rating	Plug Rating	Cat. No.
250 A	150 A	54732
	200 A	54733
	250 A	54734
400 A	200 A	54735
	250 A	54736
	300 A	54737
	400 A	54738
	300 A	54739
600 A	400 A	54740
	500 A	54741
	600 A	54742
800 A	400 A	54743
	500 A	54744
	600 A	54745
	800 A	54746
	600 A	54747
1200 A	800 A	54748
	1200 A	54750
	1200 A	54759
5000 A	3000 A	54772
	4000 A	54773
	5000 A	54774

NOTE: Mandatory for UL Listed Masterpact MP circuit breakers with STR 28D, STR 38S and STR 58U control units. Not required on IEC Rated Masterpact circuit breakers.

[1] External neutral sensor not included.
[2] External AD module (see page 11-46) is required if load is below 20% or if setting is red zone.

Masterpact™ M/MP/MC Circuit Breaker Accessories

NOTE: Masterpact M/MP/MC circuit breakers and related accessories are obsolete. Use Masterpact NT/NW for new applications. See Digest Section 7. Limited service stock is available for replacement or fill purposes. Contact the nearest sales office for product availability.

Table 11.118: Neutral Sensor for 3ØH4W Systems (TCE)


	Rating	Cat. No.
	800 A	54422
	1250 A	54426
	2000 A	54427

Table 11.119: Accessories (Must be ordered as separate items)





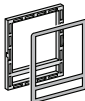
	Accessory	Description	Cat. No.
	For STR 18M to STR 58U control units Output voltage: 24 Vdc	Input voltage	
		24/30 Vdc	54440
		48/60 Vdc	54441
		10 Vac 50/60 Hz	54443
		220 Vac 50/60 Hz	54444
	380 Vac 50/60 Hz	54446	
Battery Module (BAT)			
		Battery back-up power supply for AD module	54446


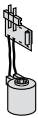

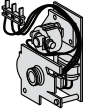



Table 11.120: Accessories for Cradle

	Accessory	Cat. No.
Position Switches		
	Four SPDT connected position switches (CE)	54590
	Two SPDT disconnected position switches (CD)	54591
Door Escutcheon		
	Can be used with fixed or drawout circuit breakers	54594

Frame Accessories

NOTE: Masterpact M/MP/MC circuit breakers and related accessories are obsolete. Use Masterpact NT/NW for new applications. See Digest Section 7. Limited service stock is available for replacement or fill purposes. Contact the nearest sales office for product availability.

Table 11.121: Accessories for Circuit Breaker Frame

		Volts (V)	Cat. No. (XF)	Cat. No. (MX)
Closing Coil (XF)/Shunt Trip (MX) (Maximum 2 shunt trips or 1 shunt trip + 1 undervoltage trip)				
	AC 50/60 Hz	110/127	54449	54449
		220/250	54503	54503
		277 [3]	54504	54504
	DC	24	54495	54495
		48	54497	54497
		100/110 [3]	54449	54449
		200/220 [3]	54503	54503
		250	54504 [3]	54504
Undervoltage Trip (MN)				
	AC 50/60 Hz	440/480	—	54481
		24	—	54470
		100/110 [3]	—	54474
	DC	200/220 [3]	—	54478
Time Delayed Undervoltage Trip (MNR) – Not UL Listed				
	AC 50/60 Hz	110/127	—	54486
		220/250	—	54488
Spring Charging Motor (MCH) — Includes Spring Charged Switch				
	AC 50/60 Hz	100/127	—	54512
		200/240	—	54513
		480 [3]	—	54518
	DC	48/60	—	54511
Four Auxiliary Switches (OF)				
	Two Standard (2a+2b) Auxiliary Switches		—	Standard
	Four changeovers (SPDT)		—	54525
One Ready to Close Switch (PF)				
	One ready to close switch		—	54528
One Overcurrent Trip Switch (SDE)				
Not available on switch version			—	Standard
OFF Position Lock by Key Lock				
	Provision for KIRK key lock		VKA	54536
	Ronis (1 key lock) with provision		VSRA1	54533




11 OBSOLETE AND OBSOLETE CIRCUIT BREAKERS

[3] Not UL Listed.

Masterpact™ M/MP/MC Circuit Breaker Spare Parts

NOTE: Masterpact M/MP/MC circuit breakers and related accessories are obsolete. Use Masterpact NT/NW for new applications. See Digest Section 7. Limited service stock is available for replacement or fill purposes. Contact the nearest sales office for product availability.

Table 11.122: Spare Parts

Spare Parts	Cat. No.		
Clusters for Cradle (Set of 2)			
	MP25–MP30 3P	M20–M25L 3P	54063 (3)
	MP25–MP30 4P	M20–M25L 4P	54063 (4)
	—	M32H 3P	54063 (3)
	—	M32H 4P	54063 (4)
	MP40–MP50 3P	M50H 3P	54063 (6)
	—	M50H 4P	54063 (7)
Charging Handle			
	One piece	685713	
Racking Handle			
	One piece	685631	
Vertical UL 489—UL 1066 Connectors			
	MP25–MP30 3P (set of three top or bottom connectors)	54107 (2)	

California Proposition 65 Message

⚠ WARNING: Some of the products listed in this document can expose you to chemicals which are known to the State of California to cause cancer, birth defects, or other reproductive harm.

For more information, go to <https://www.p65warnings.ca.gov/>.