

Features

- Patented AUTOGUARD® self test technology
- Internal back wiring clamp and guide for quick and secure termination
- Triple wipe construction

Ordering Information

Description	Color	UPC	Catalog Number
20A, 125V, Style Line®, AUTOGUARD® self test GFCI receptacle, flush face, back and side wired, multiple drive screws	White	883778122156	GFRST20W



Listings

UL Listed - Canadian and U.S.
Meets ADA Standards
Meets all NEC® requirements
CSA Certified
NEMA® WD-6 Compliant

Specifications

Face	Nylon
Base	Nylon
Power Contacts	Brass
Ground Contacts	Brass
Mounting Strap	Zinc plated steel
Mounting Screws	Zinc plated steel

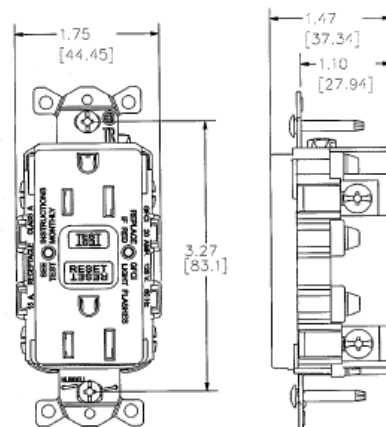

Online Resources

Customer Use Drawing
eCatalog
Installation Instructions