

**Circuit Breaker Lighting Panel Type P1**

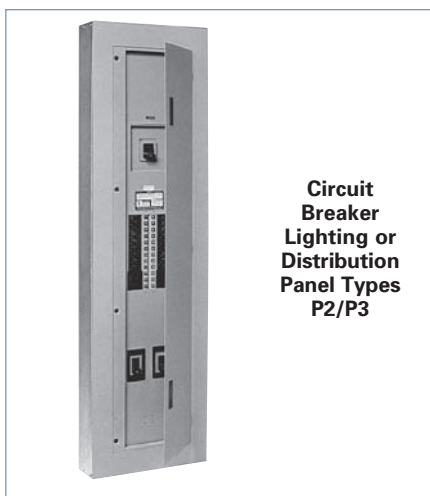

**Circuit Breaker Lighting or Distribution Panel Types P2/P3**

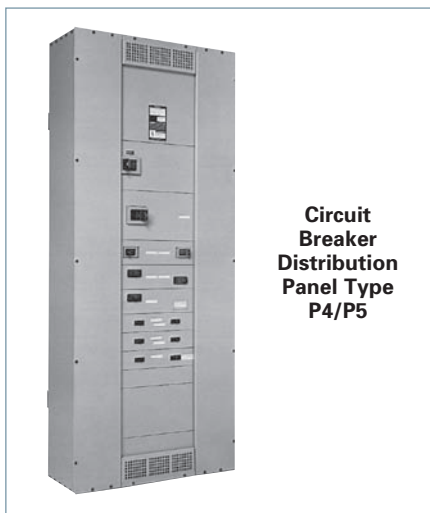

**Circuit Breaker Distribution Panel Type P4/P5**

## contents

Features, Reference Guide & General Specifications	11-2 – 11-8
Unassembled Panelboards	11-9 – 11-13
Factory Assembled Panelboard Coding System	11-15
Factory Assembled Panelboard Pricing	11-16
<b>Type P1</b>	11-17 – 11-25
Specifications	11-17
Main Lug and Main Breaker	11-18
Branch and Subfeed Breakers	11-19
Modifications and Additions	11-23 – 11-24
Enclosure Dimensions	11-25
<b>Type P2</b>	11-26 – 11-38
Specifications	11-26
Enclosure Selection/ Dimensions	11-27 – 11-28
Main Breaker and Subfeed Breakers	11-29
Branch Breakers	11-30
Main Lug and Main Breaker	11-31
Modifications and Additions	11-32 – 11-37
Enclosure Dimensions	11-38
<b>Type P3</b>	11-39 – 11-49
Specifications	11-39
Enclosure Selection/ Dimensions	11-40
Alternate Main, Branch and Subfeed Breakers	11-41 – 11-42
Main Lug and Main Breaker	11-43 – 11-44
Modifications and Additions	11-45 – 11-48
Enclosure Dimensions	11-49
3VA52 250A TMTU Breakers in P3 Panels	11-50 – 11-53
<b>Type P4</b>	11-54 – 11-66
Specifications	11-54
Enclosure Selection	11-54 – 11-56
Main Lug and Main Breaker	11-57
Main Switch and Alternate Main Breakers	11-58
Branch Devices – Circuit Breaker and Switch	11-59 – 11-60
Modifications and Additions	11-61 – 11-65
Enclosure Dimensions	11-66
<b>Type P5</b>	11-67 – 11-80
Specifications	11-67
Enclosure Selection	11-68
Main Lug and Main Breaker	11-69
Alternate Main Breaker and Main Switch	11-70
Branch Breakers	11-71 – 11-72
Branch Switches	11-73
Modifications and Additions	11-74 – 11-79
Enclosure Dimensions	11-80
<b>Column Type Panelboards</b>	11-81 – 11-84
<b>Telephone and Equipment Cabinets</b>	11-85
<b>Panelboard Modifications and Additions</b>	11-86 – 11-88
Enclosures—Relay Cabinets, NEMA 4X	11-86
Remote Switches—ASCO, LEN	11-86
Enclosure, Door, & Trim Modifications	11-87
Circuit Breaker Accessories & Panel Skirts	11-88
<b>Coordination Panels</b>	11-89 – 11-96

Scan to connect online to the most up-to-date version of this Section of SPEEDFAX.



# Panelboards

## Introduction

General

This generation of panelboards from Siemens offers the high level of engineering and innovation you've come to expect from the leader in power distribution technology. The "P Series" line of panelboards offers a stepped approach to power distribution.

Additional strength has been added to an already rugged and durable panelboard family. Engineered specifically to provide maximum flexibility, the new designs simplify wiring and reduce material requirements making them easier to install and less costly than competitive products. At the heart of the product line is the extensive research and technology found among Siemens circuit protection devices – both fusible switches and molded case circuit breakers.

The line is anchored by the innovative P1. Featuring the industry's most flexible designs, the P1 virtually eliminates common errors, such as feed direction, and main lug versus main breaker. Increasing distribution is simplified by the ability to add feed-thru lugs. The Revised P1 design introduced in January 2015 has added Extended Circuits up to 66 and has available smaller Enclosures with no Subfeed option for added flexibility

Subsequent steps in the P Series offer increased capacity and more design options:

- The highly flexible P2 provides options to fit the most demanding specifications.

- Sized more like a lighting panel, the P3 packs the power of a distribution panel in a space-saving, highly flexible design.
- The P4 is a mid-sized distribution panel that allows both fusible and circuit breaker branch and main devices.
- The powerful P5 anchors the high end of the series. With larger fusible and circuit breaker branch and main devices, the venerable P5 delivers maximum power and flexibility to larger distribution systems.

Siemens also offers a number of specialty panels, like column panels, SEM3 (Embedded Micro Metering Module™), Disaggregation Panels (which are California Title-24 compliant), and others. Don't see a panel to meet your requirements? Ask your Siemens representative about our custom capabilities.

### Features Overview

P Series lighting panel features include Fas-Latch trim, which is popular among installers; the jacking screw system, that permits adjustments even after wiring has been installed; our exclusive split neutral, and more. Many panelboards have the capability of mixing and matching breakers of different sizes and ratings – or changing from main lug to main breaker, or adding subfeed breakers without changing the box size. Other models accept a wide range of fuse types, including Siemens exclusive Vacu-Break® technology.

### Key Panelboard Features

	P1	P2	P3	P4	P5
Lighting And Appliance Applications (Pre 2008 NEC)	•	•	•	•	•
Power Panelboard Applications	—	•	•	•	•
Convertible From Top Feed To Bottom Feed Or Vice Versa	•	—	—	—	—
Change From Main Lug To Main Breaker Or Add Subfeed Without Changing Enclosure Size <sup>③</sup>	•	—	—	—	—
Space-Saving, Horizontally Mounted Main Breaker	Up To 250 Amps	Up To 250 Amps	Up To 250 Amps	•	•
Short-Circuit Rating Label Giving Performance Level	•	•	•	•	•
Standard Aluminum Ground Assembly	•	•	•	•	•
Blank End-Walls Standard <sup>①</sup>	•	•	•	•	•
Bolted Current-Carrying Parts	•	•	•	•	•
Split Neutral	•	—	•	•	•
Connection Accessible From Front	•	•	•	•	•
Screw-Type Mechanical Lugs	•	•	•	•	•
Time-Reducing Wing Nuts To Secure Interior Without Tools	•	•	•	•	•
Main and Branch Devices Connected With Case-Hardened Hardware	•	•	•	•	•
Flush Lock, Concealed Door Hinges/Trim Screws	•	•	•	—	—
Symmetrical Interior Mounting Studs To Eliminate Upside-Down Mounting of Box	•	•	•	•	•
Interior Height Adjustment For Flush Applications	•	•	•	•	•
Mix and Match Fusible Switch Circuit Breaker Capability	—	—	—	•	•
Shallow Depth	5.75"	5.75"	7.75"	10.00"	12.75"
Accepts A Wide Range Of Fuse Types	—	—	—	•	•
Accepts Vacu-Break Fusible Switch	—	—	—	•	•
Accepts A Wide Range Of Circuit Breakers	•	•	•	•	•
Accepts PDS ACCESS Communications Tie-In <sup>②</sup>	—	•	•	•	•
Optional Compression Lugs	•	•	•	•	•

• Standard

① KO's available on P1 and P2 – 5.75" Deep x 20" Wide boxes and P3 7.75" deep X 24" wide boxes.

② Panelboards equipped with Siemens Sensitrip Circuitbreakers or Power Meters can be integrated into SIEMENS PDS ACCESS Electrical Monitoring System.

③ For Revised P1, only when Subfeed Space is selected, Interior Part Number ends with "T". When "N" is at end there is no Subfeed Space available

# Panelboards

## General Specifications

General

### Class CTL Panelboards (when applicable)

Class CTL panelboards incorporate physical features which, in conjunction with the physical size, configuration, or other means provided in Class CTL circuit breakers, are designed to prevent the installation of more over current protective poles than the number for which the device is designed and rated, per UL 67 and National Electrical Code (NEC) NFPA70.

### Service Entrance Equipment

When a panelboard is used as service entrance equipment, it must be located near the point of entrance of building supply conductors. In a main lugs only panel, the number of breakers or switches directly connected to the main bus must be limited to six. In a panel having a main breaker or main switch, the number of circuits are not limited except as may be provided under other panelboard requirements, i.e., lighting and appliance branch circuit panelboards. Also, panels must include a connector for bonding and grounding the neutral conductor.

### Panelboard Code Data (where applicable)

Lighting and appliance branch circuit panelboards were included in editions of the National Electrical Code prior to 2008. The NEC no longer distinguishes between lighting and appliance panelboards and power panelboards; therefore, eliminating the 42 circuit branch circuit limitation. Adoption of this code vary by a state or local jurisdiction. Consult the local code authorities to determine if this has been adopted in that area.

### Integrated Equipment Short Circuit Rating

The term "Integrated Equipment Short Circuit Rating" refers to the application of series connected circuit breakers in a combination that allows some breakers to have lower individual interrupting ratings than the available fault current. This is permitted as long as the series combination has been tested and certified by UL.

#### Standards

NEC: 2014 (where accepted)

NEMA: PB1.1

UL: 67, 50 and 50E. Listed by Underwriter's Laboratories, Inc., under "Panelboards" File #E2269, and #E4016. Meets Federal Specification W-P-115c.

### Wire Connectors

Standard wire connectors in Siemens panels are suitable for copper or aluminum cables rated 60/75 degree. Copper main lugs are a price-added option for most panel types and some Circuit Breakers (check with Siemens sales for availability). It should be noted that most copper lugs will only accept copper cables. Some applications, 100% rated devices in particular, require that the cable and connectors be rated 90 degree but are sized to the 75 degree tables.

Standard ground connectors are also suitable for copper or aluminum wire. Ground connector assemblies (EGK, IGK) have (6) 1/0 max. and (15) #6 max. connections. The 1/0 holes are capable of connecting up (3) #10 max. wires. The #6 holes can accept up to (2) #12 max. wires. Copper ground

assemblies (ECGK, ICGK) are rated for copper wire only and have the same wiring capacity as the Al/Cu connectors.

Standard neutrals, like standard main lugs, are also rated for copper or aluminum wire. The neutral cross bar material follows the selection bus. Copper neutral lugs are rated for copper cable only and available as a price added option.

### Lug Data

#### Space Required for Mounting of Double Panels

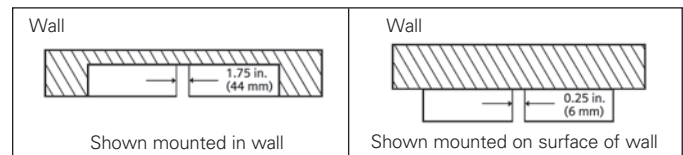

Use two or more panelboards with feed-thru or subfeed lugs when:

1. Lighting and appliance panelboards are required with more than 42 circuits in areas where the zone code has not been accepted.
2. More circuit mounting space is required than is provided in the largest box size

### Feed-Thru Lugs

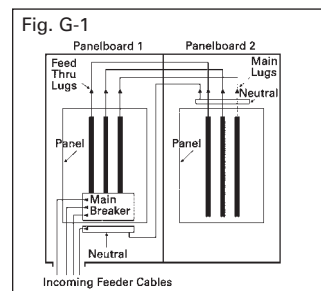

### Subfeed Lugs or Double Lug

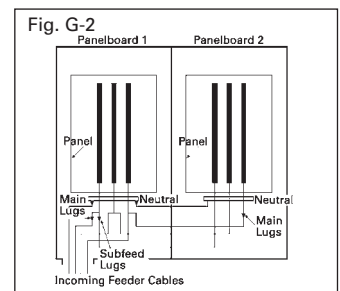

Feed-thru lugs are mounted at the opposite end of the main bus from the main lugs or main breaker and are used to connect two or more panelboards to the incoming feeder. The feeder cables are brought into Panelboard 1 and connected to the main lugs or main breaker. Cables interconnecting the two panelboards are connected to the feed-thru lugs in Panelboard 1 and are carried over the main lugs in Panelboard 2. This arrangement could be reversed with the main lugs located at the top and the feed-thru lugs at the bottom of the panel.

Subfeed lugs are mounted directly beside the main incoming lugs and are used to connect two or more panelboards to the incoming feeder. The feeder cables are brought into Panelboard 1 and connected to the main lugs. Another set of cables that are the same size are connected to the subfeed lugs of Panelboard 1 and are carried over the main lugs of Panelboard 2.

Note: P1 panelboards do not have subfeed lugs available. If this configuration is needed, move to a P2 or P3 panelboard.

# Panelboards

## General Specifications

## General

### Bussing Sequence

Interiors are designed to accommodate top or bottom feed. Regardless of which is specified, the uppermost pole is always on "A" phase; the second pole down is always on "B" phase, and the third pole down is always on "C" phase (assuming 3Ø panel).

As standard, branch breakers shall be mounted at the top of the panel with "spaces" at the bottom, regardless of the direction panel is fed.

All breakers have bolted connections except plug-in type. The panel design provides bracing up to 200,000A IR UL short circuit rating. Case-hardened, high performance, thread rolling screws are used on branch bus.

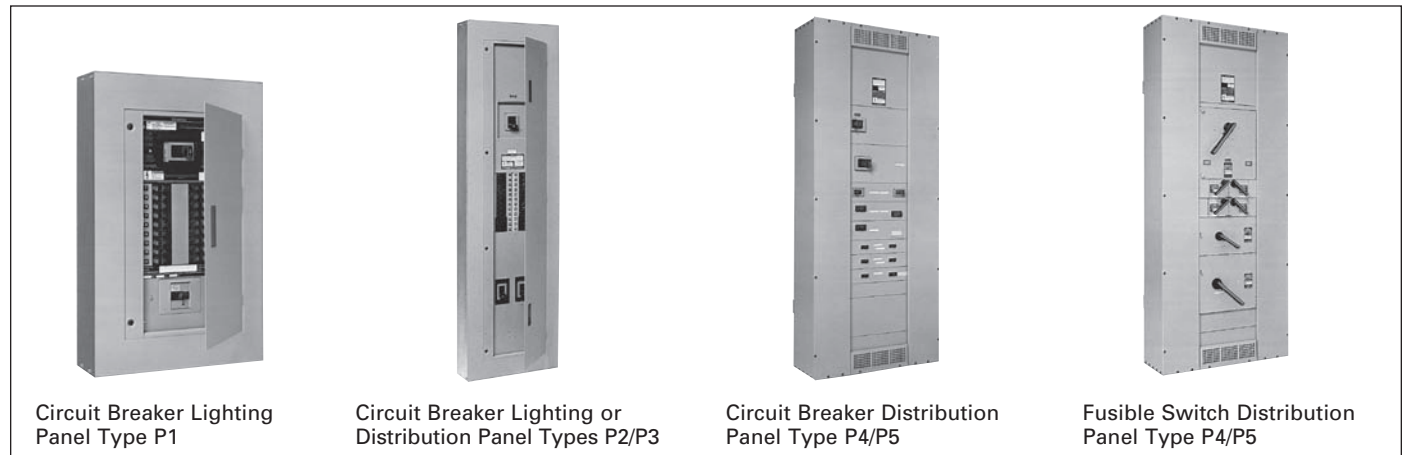

### Panelboard Ratings (Updated June 2014 with release of Revised P1 design)

Description	P1 Revised	P2	P3	P4	P5
<b>Max. Voltage</b>	480Y/277V AC Max. 600Y/347V AC <sup>ⓐ</sup>	600V AC Max. 250V DC Max.	600V AC Max. 250V DC Max.	600V AC Max. 500V DC Max.	600V AC Max. 500V DC Max.
<b>System</b>	1-Phase, 2-wire 1-Phase, 3-wire 3-Phase, 3-wire 3-Phase, 4-wire	1-Phase, 2-wire 1-Phase, 3-wire 3-Phase, 3-wire 3-Phase, 4-wire	1-Phase, 2-wire 1-Phase, 3-wire 3-Phase, 4-wire 3-Phase, 3-wire	1-Phase, 3-wire 3-Phase, 4-wire 3-Phase, 3-wire	1-Phase, 3-wire 3-Phase, 4-wire 3-Phase, 3-wire
<b>Mains</b>					
Main Lugs	125A-400A	125A-600A	250A-800A	400A-1200A	800A-1200A
Main Breaker	100A-400A	100A-600A	225A-600A	400A-800A	800A-1200A
Main Switch	—	—	—	—	200A-1200A
<b>Circuits</b>	18, 30, 42, 54, 66 (250A) 30, 42, 54, 66 (400A)	18, 30, 42, 54, 66 78, 90 <sup>ⓑ</sup>	—	—	—
<b>Branch Ratings</b>	15-125A	15-400A	15-400A	15-800A MCCB 30-200A Fusible	15-1200A MCCB 30-1200 Fusible
<b>Branch Disconnect Devices</b>	BL, BLH, HBL, BQD, BQD6 <sup>ⓐ</sup> , BLE, BLEH, BLF2, BLHF2, HBLF2, BLFB, BLHFB, BAF2, BAFH2, HBAF2, BGL, NGB <sup>ⓐ</sup> , HGB <sup>ⓐ</sup> , LGB <sup>ⓐ</sup>	BL, BLH, HBL, BQD, BQD6 <sup>ⓐ</sup> , QJ2 <sup>ⓐ</sup> , QJH2 <sup>ⓐ</sup> , QJ2H <sup>ⓐ</sup> , QR2 <sup>ⓐ</sup> , QRH2 <sup>ⓐ</sup> , HQR2 <sup>ⓐ</sup> , HQR2H <sup>ⓐ</sup> , ED4, HED4, HHED6, ED6, BLE, BLEH, BLF2, BLHF2, HBLF2, BLFB, BLHFB, BAF2, BAFH2, HBAF2, BGL, NGB, HGB, LGB, NGB2, HGB2, LGB2	BL, BLH, HBL, BQD, BQD6 <sup>ⓐ</sup> , QJ2 <sup>ⓐ</sup> , QJH2 <sup>ⓐ</sup> , QJ2H <sup>ⓐ</sup> , QR2 <sup>ⓐ</sup> , QRH2 <sup>ⓐ</sup> , HQR2 <sup>ⓐ</sup> , HQR2H <sup>ⓐ</sup> , ED4, HED4, HHED6, ED6, BLHF, BAF2, BAFH2, HBAF2, BGL, NGB, HGB, LGB, NGB2, HGB2, LGB2	All 15-600A MCCBs, VL MG at 800A and 30-200A VB switches	All 15-1200A MCCBs, 30-600A VB switches and 400-1200A HCP switches
<b>Subfeed Circuit Breakers <sup>ⓐⓑ</sup></b>	ED4, ED6, HED4, HHED6, QJ2, QJH2, QJ2H, QR2, QRH2, HQR2, HQR2H, FD6, HFD6, FXD6, HFXD6	JD6, HJD6, JXD6, HJXD6, FD6, HFD6, FXD6, HFXD6	JD6, HJD6, JXD6, HJXD6, FD6, HFD6, FXD6, HFXD6	—	—
<b>Enclosure Heights Inches – (mm)</b>	26, 32, 38, 44, 50, 56 @250A (660, 813, 965, 1118, 1270, 1422) 56, 62, 68, 74 @400A (1422, 1575, 1727, 1880)	26, 32, 38, 44, 50, 56, 62, 68, 74 (660-1880)	56, 62, 68, 74, 80 (1422-2032)	60, 75, 90 (1524, 1905, 2286)	60, 75, 90 (1524, 1905, 2286)
<b>Standard Trims</b>	Fas-Latch – 1 Piece Surface or Flush	Fas-Latch – 1 Piece Surface or Flush	Fas-Latch – 1 Piece Surface or Flush	Four Piece <sup>ⓐ</sup> Surface or Flush	Four Piece <sup>ⓐ</sup> Surface or Flush

<sup>ⓐ</sup> Functional pricing is based on circuits shown. However, the panel can be figured with less circuits.  
<sup>ⓑ</sup> P1 can have max. 1 subfeed breaker when Subfeed Space is available. P2 and P3 can have up to (2) FD subfeed breakers.  
<sup>ⓒ</sup> JD and FD breakers are mounted vertical. Limitations apply.  
<sup>ⓓ</sup> Trim ring provided for flush applications.

<sup>ⓔ</sup> A maximum of (4) QJ/QR breakers may be mounted in a P2 Panel and are single mounted.  
<sup>ⓕ</sup> A maximum of (6) QJ/QR breakers may be mounted in a P3 panel and are twin mounted.

<sup>ⓖ</sup> P1 panels with xGB breakers are limited to xGB branch devices only. BL and BQD frames may not be mixed in this panel type.  
<sup>ⓗ</sup> Factory assembled P1 has capability of 600Y/347V AC system when the proper breakers are selected.  
<sup>ⓓ</sup> BQD6 is not UL Listed. Only for CUL and CSA panels.

# Panelboards

## General Specifications

General

### Typical Panelboard Modifications

Description	Lighting and Distribution Panelboards			Distribution Panelboards	
	P1	P2	P3	P4	P5
<b>Box</b>					
Type 1	Standard (20" W)	Standard (20" W)	Standard (24" W)	Standard	Standard
Type 1 Enclosure with Hood	●	●	●	●	●
Type 1 w/Gasket between box and front	●	●	●	—	—
Type 2 Enclosure - Drip Tight (this is not available)	—	—	—	—	—
Type 3R/12	●	●	●	●	●
Type 4, 4X (size varies by type/material)	●	●	●	●	●
Wider Box (check w/factory for custom options not shown)	● (24"W)	● (24"W)	● (custom)	● (custom)	● (custom)
Deeper Box (check w/factory for custom options not shown)	● (7.75"D)	● (7.75"D)	● (custom)	● (custom)	● (custom)
<b>Front</b>					
Front with Door	Standard	Standard	Standard	●	●
4-piece Front	—	—	—	Standard	Standard
4-piece Front w/Hinged Gutter Covers	—	—	—	●	●
Hinged-to-Box Front/Screw-to-Box Front	●	●	●	(see Door-in-Door)	(see Door-in-Door)
Door-in-Door Front	●	●	●	●	●
Common Front (custom - multi section applications)	● (custom)	● (custom)	● (custom)	—	—
Special Locks	● (custom)	● (custom)	● (custom)	● (custom)	● (custom)
Nameplate (mounting provisions provided as Std - P1/P2/P3) - Nameplate text is configured in COMPAS with limitations.	●	●	●	●	●
<b>Interior</b>					
Aluminum Equipment Ground Bar	Standard	Standard	Standard	Standard	Standard
Copper Equipment Ground Bar	●	●	●	●	●
Insulated Equipment Ground (CU or AL)	●	●	●	●	●
Subfeed Lugs (see page 11-32 or 11-45)	—	●	●	●	●
Feed-Thru Lugs	●	●	●	●	●
Split Bus	—	●	●	●	●
Compression Lugs	●	●	●	●	●
Copper Lugs	●	●	●	●	●
200% Neutral	●	●	●	400 - 600A	400 - 600A
Temperature Rated - Aluminum 1	Standard	Standard	Standard	Standard	Standard
Temperature Rated - Copper 1	●	●	●	●	●
750 Ampere / in. - Aluminum	—	●	●	●	●
1000 Ampere / in. - Copper	—	●	●	●	●
Copper Plating	Tin	Tin Std./ Silver Opt.	Tin Std./ Silver Opt.	Silver	Silver
Remote Control Switches	External Mounted	●	●	●	●
Time Clocks	External Mounted	●	●	●	●
Circuit Breaker Shunt Trips	●	●	●	●	●
R, J and T Fuse Clips	—	—	—	●	●

All aluminum bus is tin-plated. ● Available as an option. — Not Available

### UL Fuse Classes<sup>①</sup>

Class	Amperes	Volts	Interrupting Ratings (kA)	$i^2t, I_i$	Circuits
H	1-600	250 and 600V or less AC	10	—	Less than 10,000A Available
K5 <sup>②</sup>	1-600	250 and 600V or less AC	100	I <sub>t</sub> – RK5 up to 100A, I <sub>i</sub> – RK5 up to 100A	Feeder circuits
J	1-600	600V or less	200	I <sub>t</sub> – Low, I <sub>i</sub> – Low	Feeder circuits (motor load small %)
RK1	1/10-600	600V or less and 250V or less	200	I <sub>t</sub> – Slightly > J, I <sub>i</sub> – Slightly > J	Feeder circuits (motor load small %)
RK5	1/10-600	600V or less and 250V or less	200	I <sub>t</sub> – > RK-1, I <sub>i</sub> – > RK-1	Motor starting currents a factor
T	1-800, 1-1200	300 and 600V or less AC	To 200	I <sub>t</sub> – Low, I <sub>i</sub> – Low	Non-Motor loads
L	601-1200	600V or less	200	I <sub>t</sub> – Low, I <sub>i</sub> – Low	Mains, feeder circuits

<sup>①</sup> Per UL 67.

<sup>②</sup> Fuses do not prohibit the use of Class H type fuse in switch.

# Panelboards

Trim / Front

Dimensions

11  
PANELBOARDS

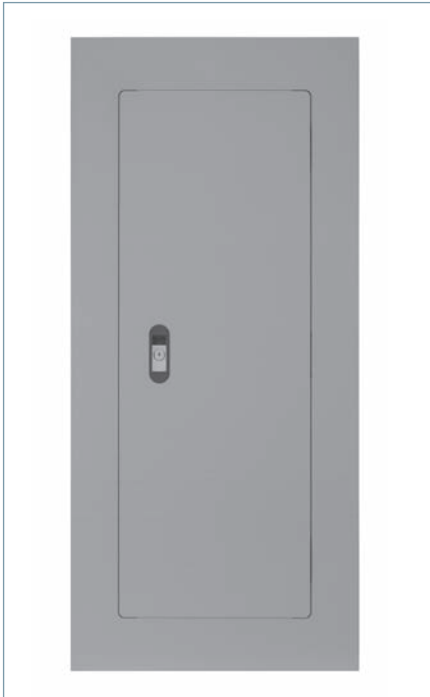

## Standard Trim (FAS-Latch) Typical Dimensions (Hinges available as shown on right side only)

(Typical 14 Gage Steel construction or UL approved equivalent)

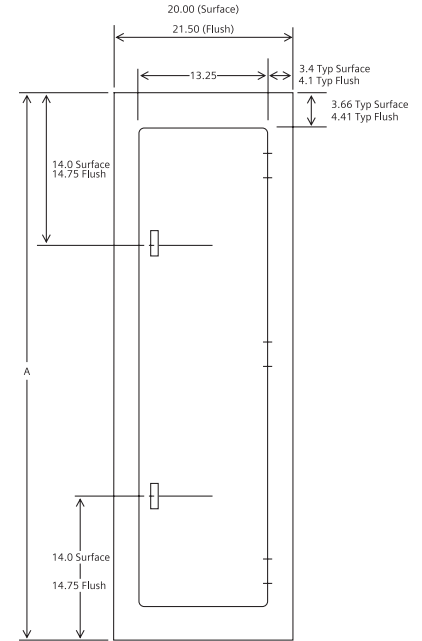
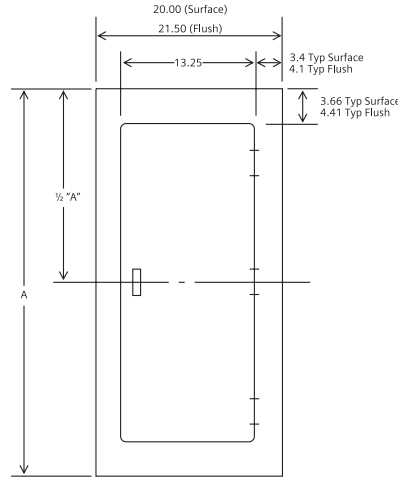

	Surface	Flush	# of Hinges
Box Size	A	A	
26	26	27.5	2
32	32	33.5	2
38	38	39.5	2
44	44	45.5	3
50	50	51.5	3

	Surface	Flush	# of Hinges
Box Size	A	A	
56	56	57.5	3
62	62	63.5	3
68	68	69.5	3
74	74	75.5	3

### Standard Trim (FAS-Latch) (14 Gage Standard - no options)

(UPB includes surface or flush versions of this style in chart on page 14. Other special fronts below are not part of the UPB program.)

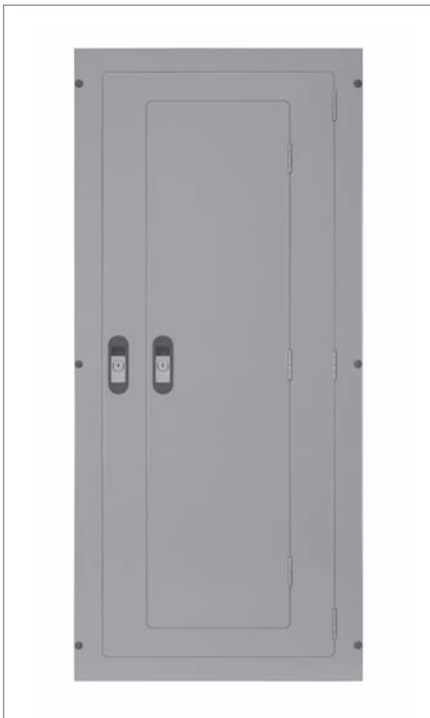

**Door in Door Front**  
(14 Gage Standard /12 Gage & 10 Gauge optional)

**Hinged to Box Front**  
(14 Gage Standard /12 Gage & 10 Gauge optional)

### Material:

- HRPO Steel painted ANSI 61 Light Grey is standard.
- 304 Stainless available with limited piano hinge options.

### Also available

- Screw to Box Trim  
(14 Gauge Std./12 Gauge & 10 Gauge Optional)
- Piano Hinge Trim  
(14 Gauge Std./12 Gauge Optional)
  - a) Screw to box with Piano Hinge Door
  - b) Hinge to Box with Piano Hinge and Piano Hinge Door
  - c) Door-in-Door with Piano Hinge, Both Doors

# Panelboards

## Special Enclosures

## Options



Type 1 Front Styles available with material, lock and hinge options.④

Push-In Panel Locks - Availability for Front/Door by Gauge③ Note: Some Styles of fronts are not available in all Gauges shown (GA).			FAS-Latch Gauge	STB (Screw-to-Box)	HTB (Hinged Front)	DND (Door-in-Door)	STB w/Piano Hinge Door	HTB w/Piano Hinge 2 places	DND w/Piano Hinge 2 places	STB 304 Stainless w/Piano Hinge Door 20" & 24" wide only	HTB 304 Stainless w/Piano Hinge 2 places 20" & 24" wide only	DND 304 Stainless w/Piano Hinge 2 places 20" & 24" wide only	Comments
Front/Door Thickness	Replacement kit # (where available) and Reference Material #	This lock is Keyed For											
0.178 max (16-14 GA)	Cat # LPLOCK01A① ref 11-1895-01	standard lock - keyed for B363A	std	std	std	std	std	std	std	std	std	std	
0.208 max (12 GA)	Cat # LPLOCK02A① ref 11-1895-02	standard lock - keyed for B363A	n/a	opt	opt	opt	opt	opt	opt	n/a	n/a	n/a	
0.238 max (10 GA)	Cat # LPLOCK03A① ref 11-1895-03	standard lock - keyed for B363A	n/a	opt	opt	opt	n/a	n/a	n/a	n/a	n/a	n/a	
0.178 max (16-14 GA)	Cat # tbd ① ref tbd	standard latch - no key provision	*	*	*	*	*	*	*	*	*	*	
<b>Special Keyed Locks② below: (Contact Customer Support if needed)</b>													
Front/Door Thickness	Ref. Material Number②	This lock is Keyed For⑤											
0.178 max (16-14 GA)	11-1896-01	Yale LL803 / GE 75 (Corbin TEY)	opt	opt	opt	opt	opt	opt	opt	opt	opt	opt	②⑤
0.178 max (16-14 GA)	11-1896-02	Yale LL806	opt	opt	opt	opt	opt	opt	opt	opt	opt	opt	②⑤
0.178 max (16-14 GA)	11-1896-03	Corbin TEU1	opt	opt	opt	opt	opt	opt	opt	opt	opt	opt	②⑤
0.178 max (16-14 GA)	11-1896-04	Corbin CAT 60	opt	opt	opt	opt	opt	opt	opt	opt	opt	opt	②⑤
0.178 max (16-14 GA)	11-1896-05	National C413A	opt	opt	opt	opt	opt	opt	opt	opt	opt	opt	②⑤
0.208 max (12 GA)	11-1896-06	Yale LL803 / GE 75 (Corbin TEY)	n/a	opt	opt	opt	opt	opt	opt	n/a	n/a	n/a	②⑤
0.208 max (12 GA)	11-1896-07	Yale LL806	n/a	opt	opt	opt	opt	opt	opt	n/a	n/a	n/a	②⑤
0.208 max (12 GA)	11-1896-08	Corbin TEU1	n/a	opt	opt	opt	opt	opt	opt	n/a	n/a	n/a	②⑤
0.208 max (12 GA)	11-1896-09	Corbin CAT 60	n/a	opt	opt	opt	opt	opt	opt	n/a	n/a	n/a	②⑤
0.208 max (12 GA)	11-1896-10	National C413A	n/a	opt	opt	opt	opt	opt	opt	n/a	n/a	n/a	②⑤
0.238 max (10 GA)	11-1896-11	Yale LL803 / GE 75 (Corbin TEY)	n/a	opt	opt	opt	n/a	n/a	n/a	n/a	n/a	n/a	②⑤
0.238 max (10 GA)	11-1896-12	Yale LL806	n/a	opt	opt	opt	n/a	n/a	n/a	n/a	n/a	n/a	②⑤
0.238 max (10 GA)	11-1896-13	Corbin TEU1	n/a	opt	opt	opt	n/a	n/a	n/a	n/a	n/a	n/a	②⑤
0.238 max (10 GA)	11-1896-14	Corbin CAT 60	n/a	opt	opt	opt	n/a	n/a	n/a	n/a	n/a	n/a	②⑤
0.238 max (10 GA)	11-1896-15	National C413A	n/a	opt	opt	opt	n/a	n/a	n/a	n/a	n/a	n/a	②⑤

① Lock kits include one replacement lock with 2 keys #B363A  
 ② See Contact list below or Contact Customer Support for re-ordering special keyed locks as needed.  
 ③ The lock options for Yale 511, BEST, Corbin 15751 and Corbin 15757 CANNOT be used in 12GA and 10GA fronts, or with any 304 Stainless Steel Fronts.  
 ④ Factory has final determination on whether combinations of non-standard features are available. Contact Customer Support for complex front configurations.

⑤ The factory does not stock keys for these locks. It's the customer's responsibility to obtain it from outside sources. See contact info for special keys below.  
 ⑥ Nema 3R/12, Nema4, Nema4X SS, Nema 4X non-metallic Enclosures cannot be used with the fas-latch lock assy.  
 ⑦ Consult Factory or Customer Support for any other special lock requirements.

Contacts for Special Keys:	
National C413A	Go to this website: <a href="http://compX.com/dist-csp.html">http://compX.com/dist-csp.html</a> ==> then lookup a distributor in your area to get keys. Or call 864-297-6655
Corbin TEU1 or CAT 60	Contact your local distributor for special keys
Yale LL803 / GE 75 (Corbin TEY)	Contact your local distributor for special keys

# Panelboards

Features / Benefits

Reference

PANELBOARDS  
11

The standard Siemens P1 panelboard has some unique features that make it easier to design for an engineer, easier to reconfigure in the field for a contractor, and easier to upgrade and maintain for the Owner. The P1 is the smallest panel in the Siemens lineup, with bus sizes up to 400A. What makes it different is the split neutral design and the open ended bus. In the Siemens panel, instead of the common single neutral bus on one end, we have a neutral bus on both sides that is cross-bussed. This makes branch wiring simpler and cleaner – the lead lengths for line and neutral can now be made nearly the same, creating more room and a neater installation. It also allows access to both ends of the bus as a standard feature – this provides the flexibility to make changes in the field, even if it wasn't part of the original configuration. New Revised P1 introduced in 2015 has extended circuits up to 66 available and also non-feed thru versions are available, without the Subfeed Space, in a 6" smaller enclosure.

## MAIN BREAKER or SUB-FEED BREAKER

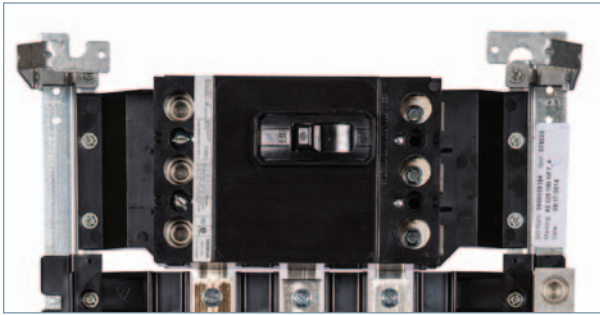

## MAIN LUGS or FEED-THROUGH LUGS



## INTEGRAL BUS MOUNTED SPD

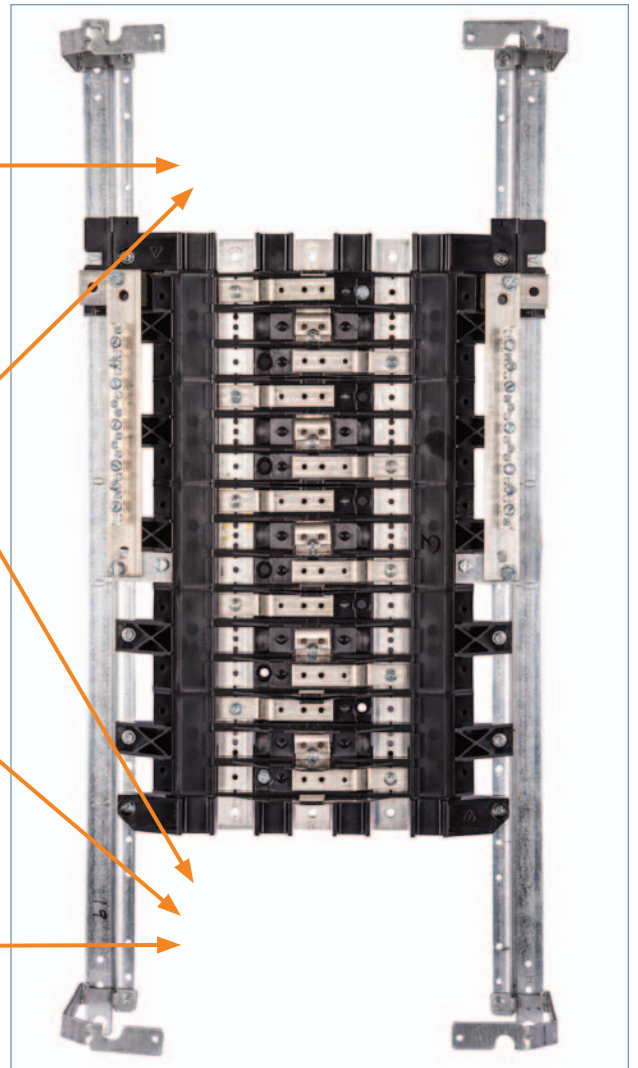

The following can be done to a standard P1 panelboard **in the field** with no modifications:

- Change from top fed to bottom fed
- Add feed-through lugs<sup>Ⓞ</sup>
- Add an Integral bus-mounted SPD<sup>Ⓞ</sup>
- Add a sub feed breaker up to 250 amps<sup>Ⓞ</sup>
- Change from Main Lugs to Main Breaker
- Change from Main Breaker to Main Lugs
- Panel may have up to two ground assemblies. Options are: (a) standard aluminum, (b) optional copper, or (c) optional insulated/isolated aluminum or copper. Mounting provisions in opposing corners of the box are standard. Any of these options may be added after installation.

<sup>Ⓞ</sup> Only when Subfeed Space is selected/available.



# Panelboards

Unassembled

Reference

Type P1 unassembled panelboards are completely convertible from main lug to main breaker and vice-versa. Additionally, feed-thru lugs up to 400 ampere or subfeed circuit breakers up to 250 ampere can be added without increasing the box height for Revised P1 with "T" suffix, see the chart.

1. When BL / BQD or GB Main Breaker is chosen as back-fed in unit space, the Main Breaker will use 2 or 3 positions of unit space and will reduce usable branch circuit space.
2. List catalog number and price of interior, box and front.
3. Select main lug kit or main breaker kit from appropriate tables.

- Note:** Main/Subfeed Breaker mounting kits may be ordered with or without breakers included, see page 11-11 and 11-12 for selection.
4. List required branch circuit breakers and filler plates to cover any unused positions.
  5. Select any modifications or accessories.

**Note:** Revised P1 was introduced in 2015. All original P1 devices do not include the "Subfeed Space" Indicator. All original P1 included the Subfeed Space as standard.

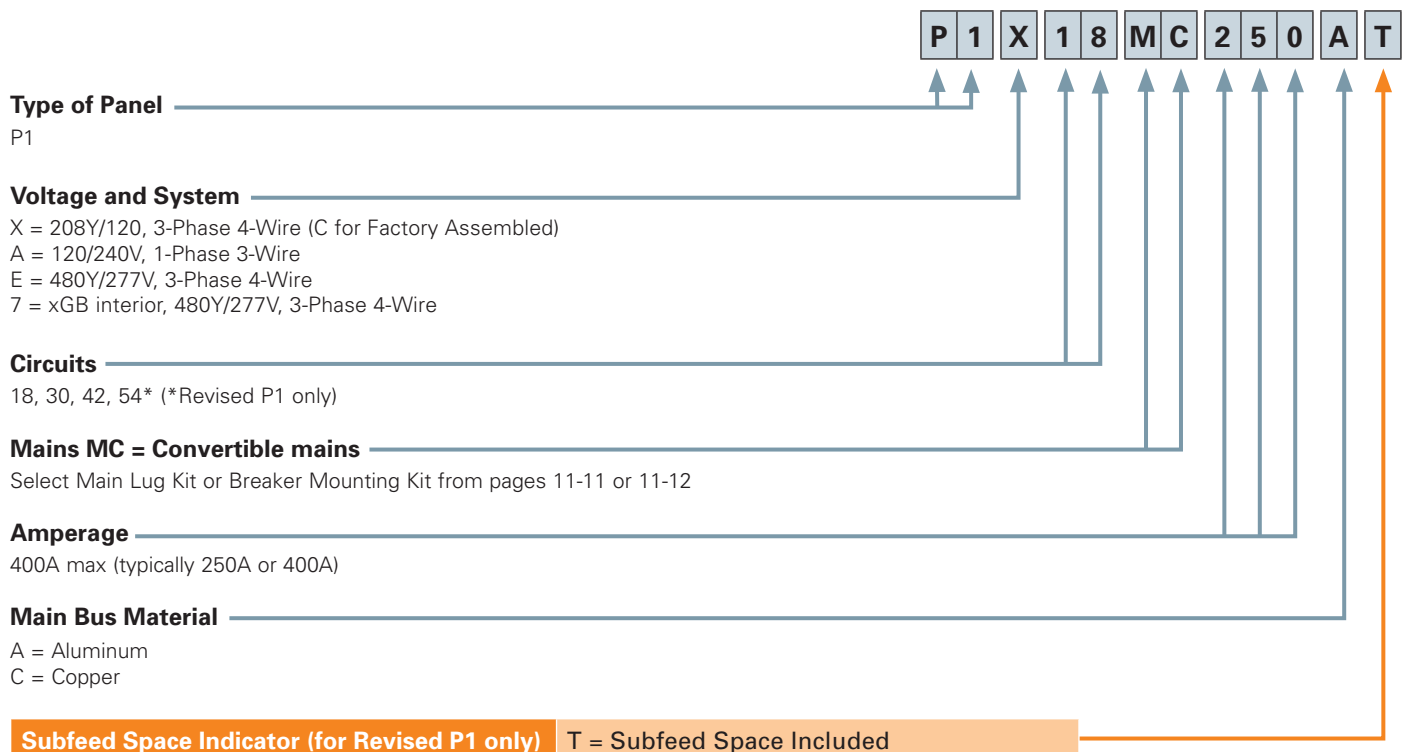

**Note:** Standard bussing in P1 panels is tin plated for aluminum and copper. Standard bus is temperature rated to the maximum amperage in the panel.

## Branch Breakers

Panel Type	Voltage (Max.)	Breaker Type	Additional Information
P1, Revised P1 <sup>①</sup>	240	BL, BLH, HBL, BQD, NGB, HGB, LGB	See Page 11-13
	480 / 277	BQD, NGB, HGB, LGB,	
	600 / 347 <sup>②</sup>	BQDG <sup>②</sup> , NGB, HGB, LGB	

<sup>①</sup> Consult sales office for availability of CSA.  
<sup>②</sup> See Speedfax for additional information.  
<sup>③</sup> 600/347V options are not available in a UPB panel – see factory assembled section.

# Panelboards

Distributor Stock – Type P1 Panelboards

Selection

PANELBOARDS 11

## Pricing An Unassembled Panel

### 400A Max. — 20" Wide x 5.75" Deep

- Choose the appropriate Interior from the table below.
- Choose the Main Device: Main Lugs from page 11-11, Main Breaker Kit from pages 11-11 to 11-12 and Main Breakers from Section 7.
- Choose Branch Breakers. BL, BQD and xGB breakers from Section 7.
- Choose Feed-Thru Lugs or Subfeed Breaker Kit from pages 11-11 to 11-12 and Subfeed Breaker from Section 7.

## Type P1 Unassembled Panelboards (Revised P1 introduced 2014)

Amps	Max. # of Poles	Original Interior Catalog Number	Revised P1 Interior Catalog Number	Box Size	Type 1 Encl.	Type 3R/12 Encl.①	Type 1 Front Surface	Type1 Front Flush
<b>Convertible Mains — 1-Phase, 3-Wire 120/240V</b>								
250	18	P1A18MC250A	P1A18MC250AT②	32	B32	WP32	S32B	F32B
	30	P1A30MC250A	P1A30MC250AT	38	B38	WP38	S38B	F38B
	42	P1A42MC250A	P1A42MC250AT	44	B44	WP44	S44B	F44B
	54		P1A54MC250AT	50	B50	WP50	S50B	F50B
400	18	P1A18MC400A	—	—	—	—	—	—
	30	P1A30MC400A	P1A30MC400AT	62	B62	WP62	S62B	F62B
	42	P1A42MC400A	P1A42MC400AT	68	B68	WP68	S68B	F68B
	54		P1A54MC400AT	74	B74	WP74	S74B	F74B
250	18	P1A18MC250C	P1A18MC250CT②	32	B32	WP32	S32B	F32B
	30	P1A30MC250C	P1A30MC250CT	38	B38	WP38	S38B	F38B
	42	P1A42MC250C	P1A42MC250CT	44	B44	WP44	S44B	F44B
	54		P1A54MC250CT	50	B50	WP50	S50B	F50B
400	18	P1A18MC400C	—	—	—	—	—	—
	30	P1A30MC400C	P1A30MC400CT	62	B62	WP62	S62B	F62B
	42	P1A42MC400C	P1A42MC400CT	68	B68	WP68	S68B	F68B
	54		P1A54MC400CT	74	B74	WP74	S74B	F74B

### Convertible Mains — 3-Phase, 4-Wire 208Y/120V

250	18	P1X18MC250A	P1X18MC250AT②	32	B32	WP32	S32B	F32B
	30	P1X30MC250A	P1X30MC250AT	38	B38	WP38	S38B	F38B
	42	P1X42MC250A	P1X42MC250AT	44	B44	WP44	S44B	F44B
	54		P1X54MC250AT	50	B50	WP50	S50B	F50B
400	18	P1X18MC400A	—	—	—	—	—	—
	30	P1X30MC400A	P1X30MC400AT	62	B62	WP62	S62B	F62B
	42	P1X42MC400A	P1X42MC400AT	68	B68	WP68	S68B	F68B
	54		P1X54MC400AT	74	B74	WP74	S74B	F74B
250	18	P1X18MC250C	P1X18MC250CT②	32	B32	WP32	S32B	F32B
	30	P1X30MC250C	P1X30MC250CT	38	B38	WP38	S38B	F38B
	42	P1X42MC250C	P1X42MC250CT	44	B44	WP44	S44B	F44B
	54		P1X54MC250CT	50	B50	WP50	S50B	F50B
400	18	P1X18MC400C	—	—	—	—	—	—
	30	P1X30MC400C	P1X30MC400CT	62	B62	WP62	S62B	F62B
	42	P1X42MC400C	P1X42MC400CT	68	B68	WP68	S68B	F68B
	54		P1X54MC400CT	74	B74	WP74	S74B	F74B

### Convertible Mains — 3-Phase, 4-Wire 480Y/277V

250	18	P1E18MC250A	P1E18MC250AT②	32	B32	WP32	S32B	F32B
	30	P1E30MC250A	P1E30MC250AT	38	B38	WP38	S38B	F38B
	42	P1E42MC250A	P1E42MC250AT	44	B44	WP44	S44B	F44B
	54		P1E54MC250AT	50	B50	WP50	S50B	F50B
400	18	P1E18MC400A	—	—	—	—	—	—
	30	P1E30MC400A	P1E30MC400AT	62	B62	WP62	S62B	F62B
	42	P1E42MC400A	P1E42MC400AT	68	B68	WP68	S68B	F68B
	54		P1E54MC400AT	74	B74	WP74	S74B	F74B
250	18	P1E18MC250C	P1E18MC250CT②	32	B32	WP32	S32B	F32B
	30	P1E30MC250C	P1E30MC250CT	38	B38	WP38	S38B	F38B
	42	P1E42MC250C	P1E42MC250CT	44	B44	WP44	S44B	F44B
	54		P1E54MC250CT	50	B50	WP50	S50B	F50B
400	18	P1E18MC400C	—	—	—	—	—	—
	30	P1E30MC400C	P1E30MC400CT	62	B62	WP62	S62B	F62B
	42	P1E42MC400C	P1E42MC400CT	68	B68	WP68	S68B	F68B
	54		P1E54MC400CT	74	B74	WP74	S74B	F74B

### Interiors for xGB Breakers — 3-Phase, 4-Wire 480Y/277V

250	18	P1718MC250A	P1718MC250AT②	32	B32	WP32	S32B	F32B
	30	P1730MC250A	P1730MC250AT	38	B38	WP38	S38B	F38B
	42	P1742MC250A	P1742MC250AT	44	B44	WP44	S44B	F44B
	54		P1754MC250AT	50	B50	WP50	S50B	F50B
400	18	P1718MC400A	—	—	—	—	—	—
	30	P1730MC400A	P1730MC400AT	62	B62	WP62	S62B	F62B
	42	P1742MC400A	P1742MC400AT	68	B68	WP68	S68B	F68B
	54		P1754MC400AT	74	B74	WP74	S74B	F74B
250	18	P1718MC250C	P1718MC250CT②	32	B32	WP32	S32B	F32B
	30	P1730MC250C	P1730MC250CT	38	B38	WP38	S38B	F38B
	42	P1742MC250C	P1742MC250CT	44	B44	WP44	S44B	F44B
	54		P1754MC250CT	50	B50	WP50	S50B	F50B
400	18	P1718MC400C	—	—	—	—	—	—
	30	P1730MC400C	P1730MC400CT	62	B62	WP62	S62B	F62B
	42	P1742MC400C	P1742MC400CT	68	B68	WP68	S68B	F68B
	54		P1754MC400CT	74	B74	WP74	S74B	F74B

① Front included in NEMA 3R and 3R/12 Box.

② The New Revised P1 (18 circuit 250A only) is limited to 100A per connection (200A per pair) when installing Branch Breakers

across from one another. All other configurations allow 125A per connection max. (250A per pair max.)



42 circuit with Back-fed Main

54 circuit 400A

# Panelboards

Distributor Stock – Type P1 Panelboards

Selection

## Lug Kits — Main or Feed Thru

Amp Rating	Mat.	Wire Range (includes Neutral)	Service	Original P1 Catalog No.	Revised P1 Catalog No.
250	AL	(1) #6 AWG-350 kcmil (CU or AL)	1 Phase	MLKA1	MLKA1A
			3 Phase	MLKA3	MLKA3A
	CU	(1) #6 AWG-350 kcmil (CU)	1 Phase	MLKC1	MLKC1A
			3 Phase	MLKC3	MLKC3A
400	AL	(2) 1/0 - 250 kcmil or (1) #2 AWG-600 kcmil	1 Phase	4MLKA1	4MLKA1A
			3 Phase	4MLKA3	4MLKA3A
	CU	(2) 1/0 - 4/0 or (1) 1/0 - 600 kcmil	1 Phase	4MLKC1	4MLKC1A
			3 Phase	4MLKC3	4MLKC3A
400	AL	(1) AL 1/0-750 kcmil (2) AL/CU 250kcmil max. [max.(1) 600 kcmil CU wire]	1 Phase	—	4MLKA1B
			3 Phase	—	4MLKA3B

## Breaker Mounting Kits 250A Max. — Main or Subfeed w/o Breaker

Ampere Rating	Breaker Types	Service	Original P1 Catalog No.	Revised P1 Catalog No. ②
100A	BL, BLH, HBL	1-Phase	MBKBL1	MBKBL1A
		3-Phase	MBKBL3	MBKBL3A
100A	BQD	1-Phase	—	MBKBC1NBA
125A	NGB, HGB, LGB		MBKNB1	
100A	BQD	3-Phase	MBKBC3	MBKBC3NBA
125A	NGB, HGB, LGB		MBKNB3	
125A	ED4, ED6, HED4, HHED6	1-Phase	MBKED1	MBKED1A
		3-Phase	MBKED3	MBKED3A
225A	QJ2, QJH2, QJ2H	1-Phase	MBKQJ1	MBKQJ1A
		3-Phase	MBKQJ3	MBKQJ3A
225A <sup>③</sup>	QR2, QRH2, HQR2, HQR2H	1-Phase	MBKQR1	MBKQR1A
		3-Phase	MBKQR3	MBKQR3A
250A	FXD6, FD6, HFD6, HFXD6	1-Phase	MBKFD1	MBKFD1A
		3-Phase	MBKFD3	MBKFD3A
400A <sup>①</sup>	JXD2, JD6, JXD6, HJD6, HJXD6	1-Phase	MBKJD1	MBKJD1A
		3-Phase	MBKJD3	MBKJD3A

① 400 amp kit is for main only — not allowed for subfeed breaker.

② MBKBFBA kit is available to mount BL/BQD/xGB 2-pole or 3-pole in unit space as a "Back-Fed Main". This occupies branch space and reduces circuit count by 2 or 3 positions. (includes Neutral Lug, "MAIN" label and instructions).

③ Although QR is rated 250A, it is limited to 225A in panelboard.

## Copper Neutral Lug Kits — 250A

No. of Circuits	Description	Original P1 Catalog No.	Revised P1 Catalog No.
18	2 or 4 Branch Neutral Strips, 1 Main Neutral Lug, Hardware	CNKL18	Use 30 ckt kit
30		CNKL30	CNLK30A
42		CNKL42	CNLK42A
54, 66		—	CNLK54A

## 2/0 Neutral Lug Kits — 250A and 400A

No. of Circuits	Description	Original P1 Catalog No.	Revised P1 Catalog No.
18	2 or 4 Branch Neutral Strips, Hardware	—	Use 30 ckt kit
30		—	LNLK30A
42		—	LNLK42A
54, 66		—	LNLK54A

## 200% Neutral Lug Kits/250A

No. of Circuits	Description	Original P1 Catalog No.	Revised P1 Catalog No.
18	2 or 4 Branch Neutral Strips, 2 Main Neutral Lugs, Hardware	2NLK18	Use 30 ckt kit
30		2NLK30	2NLK30A
42		2NLK42	2NLK42A
54, 66		—	2NLK54A

## 200% Neutral Lug Kits/400A

No. of Circuits	Description	Original P1 Catalog No.	Revised P1 Catalog No.
18	2 or 4 Branch Neutral Strips, 1 Main 600MCM Neutral Lug, Hardware	42NLK18	Use 30 ckt kit
30		42NLK30	42NLK30A
42		42NLK42	42NLK42A
54, 66		—	42NLK54A

### NOTES:

① Original P1 kits will not work with Revised P1 interiors if the chart shows different part numbers for each.

② Revised P1 kits will not work with Original P1 interiors if the chart shows different part numbers for each.

③ Field installable Service Entrance Barrier kits are now available as required by UL67 (In COMPAS, you must select Service Entrance Required).

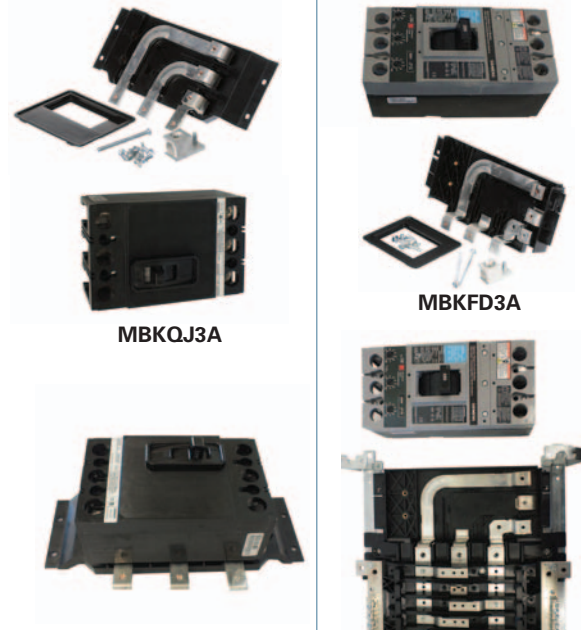

## Miscellaneous Parts and Accessories

Catalog #	Description
BK1	Bonding Kit for 400A max. Original P1 Panels
BK1A	Bonding Kit for 400A max. Revised P1 Panels
BK2	Bonding kit for S1/S2 400 & 600
BK3	Bonding kit for S3 Panel
IMK1	Interior Adjusting Kit
LPDC01	Directory Card (Pack of 10; ref. 12-1110-01)
LPDC02	Directory Card Holder (Pack of 10; ref. 11-1824-01)
MCHK	Metal Card Holder Kit
NBK03	Number Strips 1–42. Stick-on type (P1 Panels only)
NBK04	Number Strips 43–84. Stick-on type (P1 Panels only)
NBK05	Number Strips 85–126. Stick-on type (P1 Panels only)
NBK06	Number Strips 127–168. Stick-on type (P1 Panels only)
EGK	AL Ground Bus 44 Connections
ECGK	CU Ground Bus 44 Connections
IGK	Insulated AL Ground Bus
ICGK	Insulated CU Ground Bus
SEBKRP1V1 <sup>③</sup>	FD, QJ, QR Service Entrance Barrier Kit (Revised P1)
SEBKRP1V2 <sup>③</sup>	ED Service Entrance Barrier Kit (Revised P1)
SEBKRP1V3 <sup>③</sup>	BQD Service Entrance Barrier Kit (Revised P1) back-fed
SEBKRP1V4 <sup>③</sup>	xGB Service Entrance Barrier Kit (Revised P1) back-fed
SEBKRP1V5 <sup>③</sup>	BL/BQD/xGB Service Entrance Barrier Kit (RP1 in main space)
SEBKP1P2P3V1 <sup>③</sup>	JD, LD Service Entrance Barrier Kit (RP1, P1, P2, P3)
EWK1	End Wall Kit with Knockouts (20" W x 5.75" DP)
EWK2	End Wall Kit with Knockouts (24" W x 7.75" DP)
EBF1	NEB/HEB Filler Plate
P1SCRWS	Package of 42 breaker mounting screws for P1
DFFP1	1" Branch circuit filler plate (used for BL/BQD/xGB/xGB2/ED blank positions) (suitable for replacing QF3 in P1 thru P5 Panelboards and Switchboards)
P1CONBPHCU <sup>①</sup>	Connector kit – 6 pcs. B-phase Copper
P1CONBPHAL <sup>①</sup>	Connector kit – 6 pcs. B-phase Aluminum
P1CONACPHCU <sup>①</sup>	Connector kit – 6 pcs. A or C-phase Copper
P1CONACPHAL <sup>①</sup>	Connector kit – 6 pcs. A or C-phase Aluminum
MBKORFK	P1/Revised P1 Filler for 1PH/3PH QR. Horizontal mount only.
ANSI/NEMA PB 1.1-2013	General Instructions for Proper Installation, Operation, and Maintenance of Panelboards Rated 600 Volts or Less (O&M Manual) <sup>②</sup>

① Replacement parts only.

② PDF can be downloaded (at no cost) and printed at this location:

[www.nema.org/standards/pages/Panelboards.aspx](http://www.nema.org/standards/pages/Panelboards.aspx) (ref. Material #11-1056-01)

③ Factory installed and Field installable Service Entrance Barrier kits are now available as required by UL67. (In COMPAS, you must select Service Entrance Required.)

# Panelboards

Warehouse Stock/Unassembled – Type P1 Panelboards

Selection

PANELBOARDS 11

## Main Breaker Mounting Kits with Breakers for P1 Panels

(250A and lower can be used as subfeed kits also)

Original P1 Catalog No. (QJ/QR type listed where applicable)	Revised P1 Catalog No. (QJ/QR type listed where applicable)	Description	Ratings	
			240V	480V
MBKED3100	MBKED3100A	Kit w/3-pole ED4 100A breaker	65KA	18KA
MBKED3125	MBKED3125A	Kit w/3-pole ED4 125A breaker	65KA	18KA
MBKQR1 plus breaker	MBKQR1125A	Kit w/2-pole QJ2/QR2 125A breaker	10KA	—
MBKQR1 plus breaker	MBKQR1150A	Kit w/2-pole QJ2/QR2 150A breaker	10KA	—
MBKQR1 plus breaker	MBKQR1175A	Kit w/2-pole QJ2/QR2 175A breaker	10KA	—
MBKQR1 plus breaker	MBKQR1200A	Kit w/2-pole QJ2/QR2 200A breaker	10KA	—
MBKQR1 plus breaker	MBKQR1225A	Kit w/2-pole QJ2/QR2 225A breaker	10KA	—
MBKQR3 plus breaker	MBKQR3125A	Kit w/3-pole QJ2/QR2 125A breaker	10KA	—
MBKQR3 plus breaker	MBKQR3150A	Kit w/3-pole QJ2/QR2 150A breaker	10KA	—
MBKQR3 plus breaker	MBKQR3175A	Kit w/3-pole QJ2/QR2 175A breaker	10KA	—
MBKQR3 plus breaker	MBKQR3200A	Kit w/3-pole QJ2/QR2 200A breaker	10KA	—
MBKQR3 plus breaker	MBKQR3225A	Kit w/3-pole QJ2/QR2 225A breaker	10KA	—
MBKQR1 plus breaker	MBKQR1125HA	Kit w/2-pole QJ2H/HQR2 125A breaker	65KA	—
MBKQR1 plus breaker	MBKQR1150HA	Kit w/2-pole QJ2H/HQR2 150A breaker	65KA	—
MBKQR1 plus breaker	MBKQR1175HA	Kit w/2-pole QJ2H/HQR2 175A breaker	65KA	—
MBKQR1 plus breaker	MBKQR1200HA	Kit w/2-pole QJ2H/HQR2 200A breaker	65KA	—
MBKQR1 plus breaker	MBKQR1225HA	Kit w/2-pole QJ2H/HQR2 225A breaker	65KA	—
MBKQR3 plus breaker	MBKQR3125HA	Kit w/3-pole QJ2H/HQR2 125A breaker	65KA	—
MBKQR3 plus breaker	MBKQR3150HA	Kit w/3-pole QJ2H/HQR2 150A breaker	65KA	—
MBKQR3 plus breaker	MBKQR3175HA	Kit w/3-pole QJ2H/HQR2 175A breaker	65KA	—
MBKQR3 plus breaker	MBKQR3200HA	Kit w/3-pole QJ2H/HQR2 200A breaker	65KA	—
MBKQR3 plus breaker	MBKQR3225HA	Kit w/3-pole QJ2H/HQR2 225A breaker	65KA	—
MBKFD3150	MBKFD3150A	Kit w/3-pole FXD6 150A breaker	65KA	35KA
MBKFD3175	MBKFD3175A	Kit w/3-pole FXD6 175A breaker	65KA	35KA
MBKFD3200	MBKFD3200A	Kit w/3-pole FXD6 200A breaker	65KA	35KA
MBKFD3225	MBKFD3225A	Kit w/3-pole FXD6 225A breaker	65KA	35KA
MBKFD3250	MBKFD3250A	Kit w/3-pole FXD6 250A breaker	65KA	35KA
MBKJD1300 <sup>Ⓞ</sup>	MBKJD1300A <sup>Ⓞ</sup>	Kit w/2-pole JXD6 300A breaker	65KA	35KA
MBKJD3300 <sup>Ⓞ</sup>	MBKJD3300A <sup>Ⓞ</sup>	Kit w/3-pole JXD6 300A breaker	65KA	35KA
MBKJD1400 <sup>Ⓞ</sup>	MBKJD1400A <sup>Ⓞ</sup>	Kit w/2-pole JXD6 400A breaker	65KA	35KA
MBKJD3400 <sup>Ⓞ</sup>	MBKJD3400A <sup>Ⓞ</sup>	Kit w/3-pole JXD6 400A breaker	65KA	35KA
MBKJD12300 <sup>Ⓞ</sup>	MBKJD12300A <sup>Ⓞ</sup>	Kit w/2-pole JXD2 300A breaker	65KA	—
MBKJD32300 <sup>Ⓞ</sup>	MBKJD32300A <sup>Ⓞ</sup>	Kit w/3-pole JXD2 300A breaker	65KA	—
MBKJD12400 <sup>Ⓞ</sup>	MBKJD12400A <sup>Ⓞ</sup>	Kit w/2-pole JXD2 400A breaker	65KA	—
MBKJD32400 <sup>Ⓞ</sup>	MBKJD32400A <sup>Ⓞ</sup>	Kit w/3-pole JXD2 400A breaker	65KA	—

Ⓞ Kits are for Main only. New "Revised P1" kits can be used for either top feed or bottom feed.

NOTE: "Revised P1" Kits above only work for interior feed numbers ending in "T" or "N". Use "Original P1" kits for all others.

## Branch Breakers Selection for P1

### Selection Guide

1. Select breaker type.
2. Select required amperage.
3. Select number of poles.
4. Select branch breaker catalog numbers.
5. Select ground bar and filler plates. (See replacement parts & accessories on Page 11-11.)



**300A Main installed.**  
These Revised P1 kits can now be used as top or bottom feed.

## AFCI – Combination Type Arc Fault Circuit Interrupter

Breaker Type	Ampere Rating	Catalog Number	Interrupting Ratings (kA) RMS Symmetrical Amperes		
			Volts AC		
			120	120/240	240
BAF2 1-pole	15	BA115AFC	10	—	—
	20	BA120AFC	10	—	—
BAFH2 1-pole	15	BA115AFCH	22	—	—
	20	BA120AFCH	22	—	—
HBAF2 1-pole	15	BA115AFCHH	65	—	—
	20	BA120AFCHH	65	—	—
BAF 2-pole	15	B215AFC	—	10	—
	20	B220AFC	—	10	—
BAFH 2-pole	15	B215AFCH	—	22	—
	20	B220AFCH	—	22	—

## Dual Function AFCI/GFCI Circuit Breaker

Breaker Type	Ampere Rating	Catalog Number	Interrupting Ratings (kA) RMS Symmetrical Amperes		
			Volts AC		
			120	120/240	240
BFGA2 1-pole	15	B115DF	10	—	—
	20	B120DF	10	—	—
BFGAH2 1-pole	15	B115DFH	22	—	—
	20	B120DFH	22	—	—
HBFGA2 1-pole	15	B115DFHH	65	—	—
	20	B120DFHH	65	—	—

## Switching Neutrals

Breaker Type	Ampere Rating	Catalog Number	Maximum Interrupting Rating (kA)		
			120V AC	120/240V AC	240V AC
BG 2-Wire/3-Wire Common Trip	15	BG215■	10	—	—
	20	BG220■	10	—	—
	30	BG330■	—	10	—

■ Built to order.

## Branch Breakers Selection for P1

### Selection Guide

1. Select breaker type.
2. Select required amperage.
3. Select number of poles.
4. Select branch breaker catalog numbers.
5. Select ground bar and filler plates. (See replacement parts & accessories on Page 11-11.)

### BL Branch Breakers – 10,000A IR<sup>①</sup>

Amp Rating	1-Pole 120/240V	2-Pole 120/240V	2-Pole 240V	3-Pole 240V
15	B115	B215	B215R	B315
20	B120	B220	B220R	B320
25	B125	B225	B225R	B325
30	B130	B230	B230R	B330
35	B135	B235	B235R	B335
40	B140	B240	B240R	B340
45	B145	B245	B245R	B345
50	B150	B250	B250R	B350
55	B155	—	—	—
60	B160	B260	—	B360
70	B170	B270	—	B370
80	—	B280	—	B380
90	—	B290	—	B390
100	—	B2100	—	B3100

### BLH Branch Breakers – 22,000A IR<sup>①</sup>

Amp Rating	1-Pole 120/240V	2-Pole 120/240V	3-Pole 240V
15	B115H	B215H	B315H
20	B120H	B220H	B320H
25	B125H	B225H	B325H
30	B130H	B230H	B330H
35	B135H	B235H	B335H
40	B140H	B240H	B340H
45	B145H	B245H	B345H
50	B150H	B250H	B350H
55	B155H	—	—
60	B160H	B260H	B360H
70	B170H	B270H	B370H
80	—	B280H	B380H
90	—	B290H	B390H
100	—	B2100H	B3100H

### HBL Branch Breakers – 65,000A IR<sup>①</sup>

Amp Rating	1-Pole 120/240V	2-Pole 120/240V	3-Pole 240V
15	B115HH	B215HH	B315HH
20	B120HH	B220HH	B320HH
30	B130HH	B230HH	B330HH
40	B140HH	B240HH	B340HH
50	B150HH	B250HH	B350HH
60	—	B260HH	B360HH
70	—	B270HH	B370HH
80	—	B280HH	B380HH
90	—	B290HH	B390HH
100	—	B2100HH	B3100HH

### BQD Branch Breakers – 14,000A IR Max. @ 480/277 Vac / 65,000A IR max. @ 240 Vac<sup>②</sup>

Amp Rating	1-Pole 277V	2-Pole 480Y/277V	3-Pole 480Y/277V
15	BQD115	BQD215	BQD315
20	BQD120	BQD220	BQD320
25	BQD125	BQD225	BQD325
30	BQD130	BQD230	BQD330
35	BQD135	BQD235	BQD335
40	BQD140	BQD240	BQD340
45	BQD145	BQD245	BQD345
50	BQD150	BQD250	BQD350
55	BQD155	BQD255	BQD355
60	BQD160	BQD260	BQD360
70	BQD170	BQD270	BQD370
80	BQD180	BQD280	BQD380
90	BQD190	BQD290	BQD390
100	BQD1100	BQD2100	BQD3100

### GFCI Personnel Protection (5MA)

Breaker Type	Ampere Rating	Catalog Number	Interrupting Ratings (kA) RMS Symmetrical Amperes		
			Volts AC		
			120	120/240	240
BLF2 1-Pole	15	BF115A	10	—	—
	20	BF120A	10	—	—
	30	BF130A	10	—	—
BLFB 2-Pole	15	BF215A	—	10	—
	20	BF220A	—	10	—
	30	BF230A	—	10	—
	40	BF240A	—	10	—
	50	BF250A	—	10	—
BLHF2 1-Pole	15	BF115AH	22	—	—
	20	BF120AH	22	—	—
	30	BF130AH	22	—	—
BLHFB 2-Pole	15	BF215AH■	—	22	—
	20	BF220AH	—	22	—
	30	BF230AH	—	22	—
	40	BF240AH■	—	22	—
	50	BF250AH■	—	22	—
	60	BF260AH	—	22	—
HBLF2 1-Pole	15	BF115AHH	65	—	—
	20	BF120AHH	65	—	—
	30	BF130AHH	65	—	—

### GB Family Branch Breakers

NGB – 25,000 A IR Max. @ 480/277V AC / 100,000 A IR @ 240V AC

HGB – 35,000 A IR Max. @ 480/277V AC / 100,000 A IR @ 240V AC

LGB – 65,000 A IR Max. @ 480/277V AC / 100,000 A IR @ 240V AC

Amp Rating	1-pole 277V	2-pole 480Y/277V	3-pole 480Y/277V
15	xGB1B015B	xGB2B015B	xGB3B015B
20	xGB1B020B	xGB2B020B	xGB3B020B
25	xGB1B025B	xGB2B025B	xGB3B025B
30	xGB1B030B	xGB2B030B	xGB3B030B
35	xGB1B035B	xGB2B035B	xGB3B035B
40	xGB1B040B	xGB2B040B	xGB3B040B
45	xGB1B045B	xGB2B045B	xGB3B045B
50	xGB1B050B	xGB2B050B	xGB3B050B
60	xGB1B060B	xGB2B060B	xGB3B060B
70	xGB1B070B	xGB2B070B	xGB3B070B
80	xGB1B080B	xGB2B080B	xGB3B080B
90	xGB1B090B	xGB2B090B	xGB3B090B
100	xGB1B100B	xGB2B100B	xGB3B100B
110	xGB1B110B	xGB2B110B	xGB3B110B
125	xGB1B125B	xGB2B125B	xGB3B125B

Replace x with N, H or L depending on desired type of breaker  
 NOTE: 2-pole and 3-pole xGB Frame Breakers are also rated at 14,000 A IR max. for 600Y/347V AC systems. UPB interiors are only rated to 480V max. - see factory assembled section for proper interiors.

■ Built to order. Allow 8-10 weeks for delivery.

① To add shunt trip to BL breakers, see Speedfax for Breaker Accessories.

② To add shunt trip to BQD breakers, see Speedfax for Breaker Accessories.

# Panelboards

## Panelboard Replacement, Modification, and Additions

Selection

S1/S2 Panels—All the original P1 panel kits for 250 amp and below panels will work for 250 amp maximum S1/S2 panels (will not work for S1/S2 400A and above).

Note: Revised P1 kits will not work with S1/S2 or SE Panels.

## 400/600 Amp S1/S2 and All SE Panels

### Lug Kits — Main or Feed Thru

Ampere Rating	Material	Wire Range	Service	Catalog Number
125A/250A	Al/Cu	(2) 1/0–250 kcmil	1-Phase	<b>MLKA1</b>
125A/250A	Al/Cu	(2) 1/0–250 kcmil	3-Phase	<b>MLKA3</b>
400A/600A	Al/Cu	(2) #4–250 kcmil or (1) 3/0–500 kcmil	1-Phase	<b>SMLKA1</b>
400A/600A	Al/Cu	(2) #4–250 kcmil or (1) 3/0–500 kcmil	3-Phase	<b>SMLKA3</b>

Other applications:

For P4/S4 and 10" deep SPP panels see page 11-60 for branch breaker mounting kits.

For P5/S5 and 12.75" deep SPP panels see page 11-74 for branch breaker mounting kits.

For P4/F1 and 10" deep FPP panels see page 11-60 for branch fusible switch mounting kits.

For P5/F2 and 12.75" deep FPP panels see page 11-74 for branch fusible switch mounting kits.

For Series 5, Series 6, CDP6 and VB 6 panels as well as FC20, FCI, FCII, SB1, SB2 and SB3 distribution switchboards, see page 12-32 for branch device mounting kits.

## Filler Plate Replacement Kits for Lighting Panels

Ref.	Panel Type	Breaker Position	Breaker Type	Orientation	Catalog No.	Description
A	P1 & RP1, P2, P3, C1, C2	Branch & Main	BL/BQD/xGB/xGB2/ED	Horizontal or Vertical (as needed)	<b>DFFP1</b>	Blank Filler 1"
B	P1 & RP1, C1	Main / Subfeed	blank - no breaker	Horizontal or Vertical	<b>DFFP01A</b>	P1 Blank Filler Plate
C	P1 & RP1	Main / Subfeed	ED	Horizontal	<b>DFFPED01</b>	P1 125A Filler Plate
D	P1 & RP1	Main / Subfeed	QJ 2-pole	Horizontal	<b>DFFPQJ02</b>	P1 QJ Filler Plate
E	P1 & RP1	Main / Subfeed	QJ 3-pole	Horizontal	<b>DFFPQJ01</b>	P1 QJ Filler Plate
F	P1 & RP1	Main / Subfeed	QR	Horizontal	<b>MBKQRFK</b>	P1 QR Filler Plate
G	P1 & RP1	Main / Subfeed	FD	Horizontal	<b>DFFPFD01</b>	FD Filler Plate
H	P1 & RP1	Main	JD	Vertical	<b>DFFPJD01</b>	Deadfront Filler 400A Breaker
I	P2 & P3	Branch	BL/BQD/xGB/xGB2/ED	n/a	<b>DFK1</b>	Center strips included (7 sizes) 3", 6", 9", 12", 15", 18", 21" (of branch height)
J	P2 & P3	Branch	blank - no breaker	Horizontal	<b>DFFP3</b>	P2 Blank Deadfront Plate 3" P3 Blank Cover Plate 2.97"
K	P2 & P3	Branch	blank - no breaker	Horizontal	<b>DFFP6</b>	P2 Blank Deadfront Plate 6" P3 Blank Cover Plate 5.97"
L	P2	Branch	QR	Horizontal and Vertical	<b>BBKQRP1FK</b>	QR Deadfront Plate P1 QR Filler Plate P2 QR Filler Plate
M	P3	Branch	QR	Horizontal	<b>BBKQRP2FK</b>	P3 QR Deadfront Filler P3 DUAL QJ Deadfront Plate P3 DUAL QJ Deadfront Plate (1-Phase & 3-Phase) P3 QR-QJ Combo Deadfront Plate Breaker Blank Filler
N	P3	Branch	NEB/HEB	Horizontal	<b>EBF1</b>	EB Deadfront Filler
O	P3	Branch	BL, BQD, ED or GB	Horizontal	<b>DFFP3AP01</b>	P3 BL/BQD/ED/xGB adaptor plate 3" - 1 Piece per pack

### Neutral Kits

Ampere Rating	Description	Catalog Number
250A max.	30/42 circuit 200% neutral kit	<b>2NLK2</b>
400/600A max.	42 circuit 200% neutral kit	<b>2NLK1</b>

### Breaker Mounting Kits

Ampere Rating	Breaker Types	Service	Catalog Number
125A	ED2, ED4, ED6, HED4, HHED6	1-Phase	<b>SMBKED1</b>
225A	ED2, ED4, ED6, HED4, HHED6	3-Phase	<b>SMBKED3</b>
250A	FXD6, FD6, HFXD6, HFD6	1-Phase	<b>SMBKFD1</b>
250A	FXD6, FD6, HFXD6, HFD6	3-Phase	<b>SMBKFD3</b>
400A	JD6, JXD6, HJD6, HJXD6	1-Phase	<b>SMBKJD1</b>
400A	JD6, JXD6, HJD6, HJXD6	3-Phase	<b>SMBKJD3</b>
600A	LD6, LXD6, HLD6, HLXD6	1-Phase	<b>SMBKLD1</b>
600A	LD6, LXD6, HLD6, HLXD6	3-Phase	<b>SMBKLD3</b>

# Panelboards

Factory Assembled

Selection

## Catalog Numbering System

**P 1 C 4 2 F X 2 5 0 A T S T**

**Type of Panel** P1, P2, P3, P4, P5

**Voltage and System\***

C = 208Y/120 3Ø 4 W Wye AC - All (X for UPB)

E = 480Y/277 3Ø 4 W Wye AC - All

D = 240 3Ø 3 W Delta AC - All

F = 480 3Ø 3 W Delta AC - P2, P3, P4, P5

G = 600 3Ø 3 W Delta AC - P2, P3, P4, P5

I = 347 3Ø 3 W Delta AC P2, P3, P4, P5

B = 240/120 3Ø 4 W Delta BØ High Leg AC - P2, P3, P4, P5

Q = 240/120 3Ø 4 W Delta CØ High Leg AC - P2, P3, P4, P5

A = 120/240 1Ø 3 W Grounded Neutral AC - All

H = 120 1Ø 2 W Grounded Neutral AC - P2, P3, P4, P5

J = 240 1Ø 2 W No Neutral AC - All

Y = 125 1Ø 2 W Grounded Neutral AC - P2, P3, P4, P5

Z = No Longer Available

K = 220/127 3Ø 4 W Wye AC - All

M = 380/220 3Ø 4 W Wye AC - All

R = 415/240 3Ø 4 W Wye AC - All

S = 440/250 3Ø 4 W Wye AC - All

L = 600/347 3Ø 4 W Wye AC - All

T = 230 3Ø 3 W Delta AC - All

W = 380 3Ø 3 W Delta AC - P2, P3, P4, P5

1 = 24V DC 1-Pole Branch Only - P2, P3, P4, P5

2 = 24V DC 2-Pole Branch Only - P2, P3, P4, P5

3 = 48V DC 1-Pole Branch Only - P2, P3, P4, P5

4 = 48V DC 2-Pole Branch Only - P2, P3, P4, P5

5 = 125V DC 1-Pole Branch Only - P2, P3, P4, P5

N = 125V DC 2-Pole Branch Only - P2, P3, P4, P5

O = 125/250V DC 2-Pole Branch Only - P2, P3, P4, P5

P = 125/250V DC 2 & 3-Pole Branch - P2, P3, P4, P5

U = 120V AC 3Ø3W - All

V = 240V 3Ø3W Grounded B Phase - P2, P3, P4, P5

\*For any voltage system not listed, check with sales for availability.

**Circuits**

P1 - 18, 30, 42, 54, 66

P2 - 18, 30, 42, 54, 66, 78, 90

**Enclosure Height<sup>®</sup>**

P3 - 56, 62, 68, 74, 80

P4, P5 - 60, 75, 90

**Main Lug (ML), Main Breaker**

(See Main Breaker Table coding below), Main Switch (MS)

**Amperage**

100-400A = P1      250-800A = P3

100-600A = P2      400-1200A = P4, P5

**Bus Code<sup>®</sup>**

A Temp rated Al.

B 750A/sq. in. Al.

C Temp rated Cu.

E Temp rated Cu.

F Temp rated Cu.

G 1000A/sq. in. Cu.

H 1000A/sq. in. Cu.

**Bus Plating**

Tin-Plated

Tin-Plated

Tin-Plated

Silver-Plated

Tin-Plated

Tin-Plated

Silver-Plated

**P1**

•

n/a

•

n/a

n/a

n/a

n/a

**P2**

•

•

n/a

optional

•

•

optional

**P3**

•

•

n/a

optional

•

•

optional

**P4**

•

•

n/a

n/a

•

optional

•

**P5**

•

•

n/a

•

n/a

optional

•

• Indicates default for this bus type.

**Feed Location**

T = Top

B = Bottom

**Mounting**

S = Surface

F = Flush. Flush trims extend 1 1/2" beyond the base box dimensions on P1, P2 and P3; and 2" on P4 and P5 panels.

**Subfeed Space Indicator (for P1 only)**

T = Subfeed Space Included

N<sup>®</sup> = No Subfeed Space

## Main Breaker Coding

Code	Breaker Type	Code	Breaker Type	Code	Breaker Type	Code	Breaker Type	Code	Breaker Type	Code	Breaker Type	Code	Breaker Type	Code	Breaker Type
BL	BL	H2	HFXD6	J6	JD6	L6	LD6	MD	MD6	ND	ND6	L3	LLK	N8	HNG
BH	BLH	H1	HHFD6	JD	JXD2	LX	LXD6	MX	MXD6	NX	NXD6	J2	NJG	N2	HNX
BR	BLR	H3	HHFXD6	JX	JXD6	LH	LXD6H	MH	MXD6H	NT	NXD6H	J1	NJX	N5	HNY
HB	HBL	G2	HGB	JH	JXD6H	S1	SCLD6	SO	SCMD6	SR	SCND6	J4	NJY	N9	LNG
BQ	BQD	G3	LGB	SC	SCJD6	S2	SHLD6	SQ	SCMD6H	ST	SCND6H	L2	HLK	N3	LNX
B6	BQD6 <sup>®</sup>	NB	NGB	SX	SHJD6	SL	SLD6	S5	SHMD6	AD	SHND6	L7	NLK	N6	LNY
CE	CED6	G4	NGB2	SY	SHJD6H	QJ	QJ2	S6	SHMD6H	SD	SHND6H	M5	HMG	N7	NNG
E4	ED4	G5	HGB2	SJ	SJD6	Q2	QJ2H	SM	SMD6	SN	SND6	M2	HMX	N1	NNX
E6	ED6	G6	LGB2	SH	SJD6H	QH	QJH2	AX	SMD6H	AY	SND6H	M8	HMY	N4	NNY
H4	HED4	CJ	CJD6	CL	CLD6	C9	CMD6	CN	CND6	J6	HJG	M6	LMG	OR	QR2
HA	HHED6	6H	HHJD6	HH	HHLD6	CH	CMD6H	C6	CND6H	J7	HJX	M3	LMX	Q4	QRH2
CF	CFD6	H9	HHJXD6	XH	HHLXD6	HM	HMD6	HN	HND6	J5	HJY	M9	LMY	Q5	HQR2
FD	FD6	H6	HJD6	HL	HLD6	HR	HMXD6	HT	HNXD6	J9	LJG	M4	NMG	Q6	HQR2H
FX	FXD6	H5	HJXD6	HO	HLXD6	HS	HMXD6H	HX	HNXD6H	J3	LJX	M1	NMX	Q7	QR2-MCS
HF	HF6	H7	HJXD6H	HP	HLXD6H					J8	LJY	M7	NMY		

<sup>®</sup> Standard bussing in P1, P2 and P3 panels is tin-plated for aluminum and copper. Standard bus is temperature rated to the maximum amperage in the panel.

<sup>®</sup> Not available for Revised P1 xGB interiors.

<sup>®</sup> BQD6 is not UL Listed. Only for CUL and CSA panels

<sup>®</sup> P3, P4, P5 enclosure height tables found on page 11-40, 11-54 and 11-68. These show the amount of unit space available.

# Panelboards

## Type P1

- To specify a particular panelboard; list panel catalog number, branches, modifications, and price on an Estimate Sheet. Price includes interior with provisions, box, ground bar, and trim. See Example No. 1.
- When more than 66 circuits are specified for P1 a two section panel will be required. Feed-thru lugs must be priced in one section from the modifications on pages 11-23.

*NOTE: This panel does not require Subfeed Space — indicated by "N" suffix*

Panel LPA		
1 — P1C30QR225ATSN		2540.
10-20/1	25. ea.	250.
4-30/3	140. ea.	560.
		<b>3350.</b>

Example No. 1 (pricing not current)

Example No. 2 is a two section panel, each having 42 circuits. Section One will contain 1-225/3 QR2 main breaker (top feed), 250A feed-thru lugs and 21" of unit space. Section Two will contain 250A main lugs only (bottom feed) and 21" of unit space. Sections will be 44" in height.

*NOTE: This panel does include Subfeed Space — indicated by "T" suffix*

Panel LPB		
1 — P1C42QR225ATST		2760.
1 — P1C42ML250ATST		1330.
1 — Feed-Thru Lugs		190.
		<b>4280.</b>

Example No. 2 (pricing not current)

- Standard main breakers are indicated by the 6th and 7th positions in the catalog number. If any other main breaker type is required, replace with the appropriate code from page 11-15. See Example No. 3.
- All panel modifications must be listed and priced separately.
- If the boxes are to be sized the same then each panel must have the same amount of unit space.

*NOTE: This panel does include Subfeed Space — indicated by "T" suffix*

Panel LPC		
1 — P1C42HF250CTST		3160.
HFD6 Main		1900.
42-20/1 BLH	35. ea.	1470.
Cu Bus		255.
Type 3R		860.
		<b>7645.</b>

Example No. 3 (pricing not current)

## Type P2

Type P2 panelboards are priced the same as Type P1 described above except for two section panels.

- When more than 42 circuits are specified for P2, a two section panel will be assumed. Main breaker codes in the 5th and 6th positions will dictate the use of feed-thru lugs. An "ML" in the fifth and sixth positions will dictate the use of subfeed lugs for 125A and 250A and feed-thru lugs for 400A and 600A.

Boxes will be sized the same for two section panels.

Base price includes all provisions. Subfeed or feed-thru lugs as required must be priced separately.

Example No. 4 is a two section panel, each having 42 circuits. Section One will contain 1-400/3 JXD6 main breaker (top feed), 225A feed-thru lugs, and 21" of unit space. Section Two will contain 400A main

lugs only (bottom feed) and 21" of unit space. Sections will be 53" in height.

## Types P3, P4 and P5

- To specify a particular panelboard, first determine voltage, system, amperage and type of main, amperage and type of branch devices, and modifications if any. (Step 1)

- List branch devices and modifications requiring space additions. List unit space requirements of each.

Note: Some units are twin mounted meaning two breakers occupy the same unit space.

Select appropriate enclosure height from selection chart on pages 11-40, 11-54, or 11-68, based on unit space requirements. (Step 2)

- Select panelboard catalog number from appropriate table based upon voltage, system, amperage and unit space requirements. (Step 3)

### Step #1

Amperage	400
Voltage	208Y/120
System	3-phase 4-wire
Main	Main Breaker
Branches	5-125/3, 2-225/3, 1-250/3
Modification	None
Feed	Top
Mounting	Surface

### Step #2 Unit Space Calculation

5-125/3 QR2	5" = 15"
5-225/3 QR2	5" = 5"
1-250/3 FXD6	5" = 5"
	25"
Enclosure is B275 from Selection Chart on page 11-47. (32" wide, 75" high, 10" deep).	

### Step #3

1—P4C75JX400ATS		\$ 4210.
5-125/3 QR2	940.	4700.
2-225/3 QR2	940.	1880.
1-250/3 FXD6	2700.	2700.
		<b>13490.</b>

(pricing not current)



# Panelboards

Circuit Breaker / Lighting and Distribution

General

## Revised Type P1

**480Y/277 Vac Maximum  
600Y/ 347 Vac Maximum (limited  
applications)  
400 Ampere Mains  
400 Ampere Maximum Branch  
UL Short Circuit Rating —  
200,000 A. @ 240 Vac / 100,000 A. @  
480/277 Vac. IR Maximum**

**Branch Breaker Symmetrical  
Interrupting Capacity**

**Based on Underwriters' Test Procedure**

Feed thru and subfeed lugs may result in lower interrupting ratings if not protected by a main device. Consult sales office.

Meets 2014 NEC wire bending requirement, section 408.55.

Meet Federal Specification W-P-115C.

### Panelboards

Listed by Underwriters' Laboratories, Inc., under "Panelboards" File #E2269 for interiors and #E4016 for boxes and fronts.

### Service

1-phase 2-wire - 120 Vac, 240 Vac,

1-phase 3-wire - 120/240 Vac,

3-phase 3-wire - 480Y/277 (when derived from 3-phase 4-wire system), 240 Vac, 120 Vac

3-phase 4-wire - 208Y/120 Vac, 480Y/277 Vac, 600Y/347 Vac, 380/220 Vac.

### Panelboard Fronts and Doors

Standard panelboards are furnished with trim featuring concealed fasteners and hinges with a flush door lock. All are factory-assembled for ease of installation. Fronts are fabricated from code gauge steel and finished ANSI-61. See page 11-86 for optional fronts.

### Main Breakers

BL, BLH, HBL, NGB, HGB, LGB, BQD, ED4, ED6, HED4, QR2, QRH2, HQR2, HQR2H, FXD6, FD6, HFD6, HFXD6, JXD6, JD6, HJXD6, HJD6.

(All main breakers except 400 amp frame are mounted horizontal.)

**Note: Revised P1 interiors with BL, BQD or GB Type Mains can be Back-fed in unit space. See special Notes for unit space reduction.**

Ⓢ P1 400 amp main breaker panels have wire bending space available for 600 kcmil.

Ⓢ 400A main breaker is vertical mounted.

For inches / millimeters conversion, see Application Data section.

### Main Breaker Panel Connectors

Ampere Rating	Connectors Suitable for Cu or Al
100	(1)—#14 1/0 AWG
125	(1)—#4 1/0 AWG
225	(1)—#4 AWG-300 kcmil
250	(1)—#4/0 AWG-350 kcmil Al (1)—#6/0 AWG-350 kcmil Cu
400 <sup>Ⓢ</sup>	(2)—#3/0 AWG-250 kcmil Al or (1)—#3/0 AWG-500 kcmil Al

Connector ranges indicated do not apply to all main breaker types. Refer to molded case circuit breaker standard pressure wire connector chart (Section 7) for the connector range of a specific frame.

### Main Lug Connectors

125	(1)—#6 AWG-350 kcmil
250	(1)—#6 AWG-350 kcmil
400 std.	AL (2) 110-250 kcmil or (1) #2 AWG-600 kcmil
400 opt.	CU (2) 1/0-4/0 or (1) 110-600 kcmil
400 opt.	AL (1) AL 1/0-750 kcmil (2) AL/CU 250 kcmil max. [max. (1) 600 kcmil (1) wire]

### Boxes

20" wide, 5.75" deep

- End walls are blank as standard.
- End walls with knockouts will be supplied at no charge on 5.75" deep panels if requested at time of order.

### Main Breaker Gutter Dimensions (inches)

Main Breaker	Side Gutter		Neutral Location
	20" w/box	24" w/box	20" w/box
BL, BLH, HBL	8.680	10.690	10.500
BQD <sup>Ⓢ</sup>	7.880	9.880	10.500
NGB, LGB, HGB	7.770	9.770	10.500
ED4, ED6, HED4	6.125	8.125	10.500
QR2, QRH2, HQR2, HQR2H	6.500	8.500	10.500
FD6, FXD6, HFD6, HFDX6	5.250	7.250	10.500
JD6 <sup>Ⓢ</sup> , JXD6 <sup>Ⓢ</sup>	15.000	15.000	26.750

### Main Lug End Gutter Dimensions (inches)

Amp Rating	End Gutter	Neutral Location
125	10.500	11.500
250	10.500	11.500
400 <sup>Ⓢ</sup>	25.500	26.750

Ⓢ Feed-thru lug wire bending space is 15.000" and neutral wire bending space is 15.880" on 400A panel.

Ⓢ P1 panel limited to (1) subfeed 250 amperes max.

### Side Gutter Wiring Space (inches)

Reference Letter	Panel Width 20"	Panel Width 24" (Optional)
A	6.375	7.375
B	5.500	7.500
C	6.125	8.125
D	6.500	8.500
E <sup>Ⓢ</sup>	5.250	7.250
F	5.000	7.000

### Branch Breaker Side Gutters

← A →	BL, BLH, HBL	BL, BLH, HBL	← A →
	BLF, BLHF	BLF, BLHF	
← B →	BQD	BQD	← B →
← C →	ED4, ED6, HED4, HHED6		
← D →	QR2, QRH2, HQR2, HQR2H		
← E →	FXD6, FD6, HFD6, HFDX6 <sup>Ⓢ</sup>		
← F →	xGB	xGB	← F →

### Weight — Approximate

Total panelboard weight when filled with a normal quantity of breakers and accessories is:

- About 3 lbs. per inch of box height

### Gauge Steel Boxes (Type 1)

Width	Height	Gauge Steel
20"	All	#16

### Fronts — Surface, Flush (Type 1)

20"	All	#14
-----	-----	-----

### Series Connected Short Circuit Ratings

The term "Series Connected Short Circuit Rating" refers to the application of series connected circuit breakers in a combination that allows some breakers to have lower individual interrupting ratings than the available fault current. This is permitted as long as the series combination has been tested and certified by UL.

The table below lists specific main and branch breaker series combinations that are marked on all P1 panels. All combinations shown have been tested for use in P1 panelboards and are UL listed. Other combinations are available. See Circuit Breaker Section, of this book.

These series ratings must be specified on order at time of entry.

Ⓢ See Branch Breaker Side Gutter Chart for Revised P1 Backfed Options.

# Panelboards

Circuit Breaker / Lighting and Distribution

Selection

PANELBOARDS 11

**Shown with Standard Mains, Top Fed and Surface Trim**  
Catalog number is for aluminum main bus. For optional copper main bus change "A" in position 11 to "C".

Panels are top feed, surface mounted. For bottom feed, change "T" in position 12 to "B". For flush mounting, change "S" in position 13 to "F".

Replace fifth and sixth position in panelboard catalog number, with alternate main breaker code.

Note: Original P1 was produced until 2015 and in January the revised P1 was introduced. All interior numbers that end with "T" or "N" are the new Revised interiors. "T" at end of catalog number indicates there is a Subfeed area available. "N" at end of catalog number indicates there is no Subfeed area available.

**Table P1-16 – Main Lugs Only**

Main Lug Only			Original P1 – Subfeed Space	Revised P1 – Subfeed Space <sup>①③</sup>	Original P1 – Subfeed Space	Revised P1 – Subfeed Space <sup>①③</sup>	Original P1 – Subfeed Space	Revised P1 – Subfeed Space <sup>①③④</sup>
Max Panel Amp Rating	Max 1-Pole Circuits	Box Height (in.)	208Y/120V 3-Phase 4-Wire Catalog #	208Y/120V 3-Phase 4-Wire Catalog #	120/240V 1-Phase 3-Wire Catalog #	120/240V 1-Phase 3-Wire Catalog #	480Y/277V 3-Phase 4-Wire Catalog #	480Y/277V 3-Phase 4-Wire Catalog #
125	18	32	P1C18ML125ATS	P1C18ML125ATST <sup>②</sup>	P1A18ML125ATS	P1A18ML125ATST <sup>②</sup>	P1E18ML125ATS	P1E18ML125ATST <sup>②</sup>
	30	38	P1C30ML125ATS	P1C30ML125ATST	P1A30ML125ATS	P1A30ML125ATST	P1E30ML125ATS	P1E30ML125ATST
	42	44	P1C42ML125ATS	P1C42ML125ATST	P1A42ML125ATS	P1A42ML125ATST	P1E42ML125ATS	P1E42ML125ATST
	54	50	N/A	P1C54ML125ATST	N/A	P1A54ML125ATST	N/A	P1E54ML125ATST
	66	56	N/A	P1C66ML125ATST	N/A	P1A66ML125ATST	N/A	P1E66ML125ATST
250	18	32	P1C18ML250ATS	P1C18ML250ATST <sup>②</sup>	P1A18ML250ATS	P1A18ML250ATST <sup>②</sup>	P1E18ML250ATS	P1E18ML250ATST <sup>②</sup>
	30	38	P1C30ML250ATS	P1C30ML250ATST	P1A30ML250ATS	P1A30ML250ATST	P1E30ML250ATS	P1E30ML250ATST
	42	44	P1C42ML250ATS	P1C42ML250ATST	P1A42ML250ATS	P1A42ML250ATST	P1E42ML250ATS	P1E42ML250ATST
	54	50	N/A	P1C54ML250ATST	N/A	P1A54ML250ATST	N/A	P1E54ML250ATST
	66	56	N/A	P1C66ML250ATST	N/A	P1A66ML250ATST	N/A	P1E66ML250ATST
400	18	56	P1C18ML400ATS	—	P1A18ML400ATS	—	P1E18ML400ATS	—
	30	62	P1C30ML400ATS	P1C30ML400ATST	P1A30ML400ATS	P1A30ML400ATST	P1E30ML400ATS	P1E30ML400ATST
	42	68	P1C42ML400ATS	P1C42ML400ATST	P1A42ML400ATS	P1A42ML400ATST	P1E42ML400ATS	P1E42ML400ATST
	54	74	—	P1C54ML400ATST	—	P1A54ML400ATST	—	P1E54ML400ATST
	66 <sup>②</sup>	74 <sup>②</sup>	—	P1C66ML400ATSN <sup>②</sup>	—	P1A66ML400ATSN <sup>②</sup>	—	P1E66ML400ATSN <sup>②</sup>

**Table P1-17 – Main Circuit Breaker**

100	18	32	P1C18BL100ATS	P1C18BL100ATST <sup>②</sup>	P1A18BL100ATS	P1A18BL100ATST <sup>②</sup>	P1E18BD100ATS	P1E18BD100ATST <sup>②</sup>
	30	38	P1C30BL100ATS	P1C30BL100ATST	P1A30BL100ATS	P1A30BL100ATST	P1E30BD100ATS	P1E30BD100ATST
	42	44	P1C42BL100ATS	P1C42BL100ATST	P1A42BL100ATS	P1A42BL100ATST	P1E42BD100ATS	P1E42BD100ATST
	54	50	—	P1C54BL100ATST	—	P1A54BL100ATST	—	P1E54BD100ATST
	66	56	—	P1C66BL100ATST	—	P1A66BL100ATST	—	P1E66BD100ATST
125	18	32	P1C18NB125ATS	P1C18NB125ATST <sup>②</sup>	—	—	P1E18NB125ATS	P1E18NB125ATST <sup>②</sup>
	30	38	P1C30NB125ATS	P1C30NB125ATST	—	—	P1E30NB125ATS	P1E30NB125ATST
	42	44	P1C42NB125ATS	P1C42NB125ATST	—	—	P1E42NB125ATS	P1E42NB125ATST
	54	50	—	P1C54NB125ATST	—	—	—	P1E54NB125ATST
	66	56	—	P1C66NB125ATST	—	—	—	P1E66NB125ATST
225	18	32	P1C18QR225ATS	P1C18QR225ATST <sup>②</sup>	P1A18QR225ATS	P1A18QR225ATST <sup>②</sup>	P1E18FX250ATS	P1E18FX225ATST <sup>②</sup>
	30	38	P1C30QR225ATS	P1C30QR225ATST	P1A30QR225ATS	P1A30QR225ATST	P1E30FX250ATS	P1E30FX225ATST
	42	44	P1C42QR225ATS	P1C42QR225ATST	P1A42QR225ATS	P1A42QR225ATST	P1E42FX250ATS	P1E42FX225ATST
	54	50	—	P1C54QR225ATST	—	P1A54QR225ATST	—	P1E54FX225ATST
	66	56	—	P1C66QR225ATST	—	P1A66QR225ATST	—	P1E66FX225ATST
250	18	32	P1C18FX250ATS	P1C18FX250ATST <sup>②</sup>	P1A18FX250ATS	P1A18FX250ATST <sup>②</sup>	P1E18FX250ATS	P1E18FX250ATST <sup>②</sup>
	30	38	P1C30FX250ATS	P1C30FX250ATST	P1A30FX250ATS	P1A30FX250ATST	P1E30FX250ATS	P1E30FX250ATST
	42	44	P1C42FX250ATS	P1C42FX250ATST	P1A42FX250ATS	P1A42FX250ATST	P1E42FX250ATS	P1E42FX250ATST
	54	50	—	P1C54FX250ATST	—	P1A54FX250ATST	—	P1E54FX250ATST
	66	56	—	P1C66FX250ATST	—	P1A66FX250ATST	—	P1E66FX250ATST
400	18	56	P1C18JX400ATS	—	P1A18JX400ATS	—	P1E18JX400ATS	—
	30	62	P1C30JX400ATS	P1C30JX400ATST	P1A30JX400ATS	P1A30JX400ATST	P1E30JX400ATS	P1E30JX400ATST
	42	68	P1C42JX400ATS	P1C42JX400ATST	P1A42JX400ATS	P1A42JX400ATST	P1E42JX400ATS	P1E42JX400ATST
	54	74	—	P1C54JX400ATST	—	P1A54JX400ATST	—	P1E54JX400ATST
	66 2	74 2	—	P1C66JX400ATSN <sup>②</sup>	—	P1A66JX400ATSN <sup>②</sup>	—	P1E66JX400ATSN <sup>②</sup>

**Table P1-18 – Standard Enclosures**

Box Height (in.)	Catalog Number				
	Type 1 Standard Trim				
	Box <sup>③</sup>	Surface <sup>④</sup>	Flush <sup>⑤</sup>	Type 3R <sup>⑦</sup>	Type 3R/12 <sup>⑦</sup>
26	B26	S26B	F26B	NR26	WP26
32	B32	S32B	F32B	NR32	WP32
38	B38	S38B	F38B	NR38	WP38
44	B44	S44B	F44B	NR44	WP44
50	B50	S50B	F50B	NR50	WP50
56	B56	S56B	F56B	NR56	WP56
62	B62	S62B	F62B	NR62	WP62
68	B68	S68B	F68B	NR68	WP68
74	B74	S74B	F74B	NR74	WP74

**① For all products without subfeed space - change "T" at end to "N" and reduce box size by 6".**

- ② No sub-feed space only for 400A 66 circuit.
- ③ BL/BQD/GB Type Mains are only available as Back-Fed. No kits are available for use in Main or Sub-feed space. (GB Type includes NGB, HGB and LGB Breakers). These breakers take up branch circuit space.
- ④ xGB interiors are not available as Non-Feed-Thru, without Subfeed Space.
- ⑤ 16 GA std., Optional 14 GA & 12 GA Enclosures only.
- ⑥ 14 Gauge Steel only.
- ⑦ 16 Gauge Can w/ 14 Gauge Front.
- ⑧ The New Revised P1 (18 circuit 250A only) is limited to 100A per connection (200A per pair) when installing Branch Breakers across from one another. All other configurations allow 125A per connection max. (250A per pair max.)

# Panelboards

Circuit Breaker / Lighting and Distribution

Selection

**Table P1-3 – Main Breaker Panel Size Selector – Revised P1**

Max Ampere rating	Main Breaker Types	Connections suitable for Cu or Al	Max # Poles FT <sup>1</sup>	Max # Poles NFT	Dimensions in inches (mm)			Weight in Lbs. (kg)
					Unit Space		Box Height B	
					FT A	NFT A		
100	BL <sup>Ⓢ</sup> , BLH <sup>Ⓢ</sup> , HBL <sup>Ⓢ</sup> , BQD <sup>Ⓢ</sup>	#8-#6 AWG Cu or Al #8-6 AWG Cu or #8-4 AWG Al #8-#1 AWG Cu or #6-#1/0 AWG Al		18	–	9	26 (661)	90 (41)
			18	30	9	15	32 (813)	105 (48)
			30	42	15	21	38 (965)	120 (55)
			42	54	21	27	44 (1118)	135 (61)
			54	66	27	33	50 (1270)	150 (67)
			66	–	33	–	56 (1423)	165 (73)
125	NGB <sup>Ⓢ</sup> , HGB <sup>Ⓢ</sup> , LGB <sup>Ⓢ</sup>	15-30 amp: #14-#6 Cu or #12-#6 Al 35-125 amp: #6-1/0 Cu #4-2/0 Al		18	–	9	26 (661)	95 (43)
			18	30	9	15	32 (813)	110 (50)
	ED4	#14-#10 AWG Cu or #12-10 AWG Al	30	42	15	21	38 (965)	125 (57)
			42	54	21	27	44 (1118)	140 (64)
			54	66	27	33	50 (1270)	155 (71)
ED6, HED4	#3-3/0 Cu or #1-2/0 Al #3-3/0 Cu or #1-2/0 Al	66	–	33	–	56 (1423)	170 (78)	
225	QR2, QRH2, HQR2, HQR2H	#6 AWG-300 Kcmil (Cu) or #4 AWG-300 Kcmil (Al)		18	–	9	26 (661)	95 (43)
			18	30	9	15	32 (813)	110 (50)
			30	42	15	21	38 (965)	125 (57)
250	FXD6, FD6, HFD6, HFXD6	#6 AWG-350 Kcmil (Cu) or #4 AWG-350 Kcmil (Al)	42	54	21	27	44 (1118)	140 (64)
			54	66	27	33	50 (1270)	155 (71)
			66	–	33	–	56 (1423)	170 (78)
400	JD6, JXD6, HJD6, HJXD6	3/0-500 Kcmil (Cu) or 4/0-500 Kcmil (Al)	–	30	–	15	56 (1423)	172 (78)
			30	42	15	21	62 (1575)	190 (86)
			42	54	21	27	68 (1728)	208 (95)
			54	66	27	33	74 (1880)	226 (104)

**Note:** Main breakers use breaker connectors. For sizes, see breaker connector chart. 400A MLO Panels have wire bend space for 600kcmil CU & AL wire when using standard lugs. With optional 750kcmil AL/CU connectors, wire bend space is available for up to 750kcmil AL wire, but is still limited to 600kcmil CU wire.

Ⓢ 400A 66 circuit only available with non-feed thru versions.

Ⓢ BL, BLH, HBL, BQD, and xGB mount in unit space and count in max. # of poles.

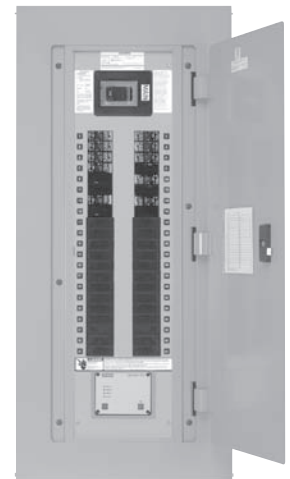
**Table P1-4 – Main Breaker Selection**

Ampere rating	Breaker Types	Max. Ir (kA) at		Main Breaker Code	Additional Trip Values
		240 AC	480/277V AC		
100	BL (STD)	10		BL	15, 20, 25, 30, 35, 40, 45, 50, 60, 70, 80, 90, 100
	BLH	22		BH	15, 20, 25, 30, 35, 40, 45, 50, 60, 70, 80, 90, 100
	HBL	65		HB	15, 20, 25, 30, 35, 40, 45, 50, 60, 70, 80, 90, 100
	BQD	65	14	BQ	15, 20, 25, 30, 35, 40, 45, 50, 60, 70, 80, 90, 100
125	NGB (STD)	100	25	NB <sup>Ⓢ</sup>	50, 60, 70, 80, 90, 100, 110, 125
	HGB	100	35	G2 <sup>Ⓢ</sup>	50, 60, 70, 80, 90, 100, 110, 125
	LGB	100	65	G3 <sup>Ⓢ</sup>	50, 60, 70, 80, 90, 100, 110, 125
	ED4 (STD)	65	18	E4	50, 60, 70, 80, 90, 100, 110, 125
	ED6 (3-pole) <sup>Ⓢ</sup>	65	25	E6	60, 70, 80, 90, 100, 110, 125
	HED4	42	42	H4	50, 60, 70, 80, 90, 100, 110, 125
225	QR2	10		QR	100, 110, 125, 150, 175, 200, 225
	QRH2	25		Q4	100, 110, 125, 150, 175, 200, 225
	HQR2	65		Q5	100, 110, 125, 150, 175, 200, 225
	HQR2H	100		Q6	100, 110, 125, 150, 175, 200, 225
250	FXD6 (STD)	65	35	FX	70, 80, 90, 100, 110, 125, 150, 175, 200, 225, 250
	FD6	65	35	FD	70, 80, 90, 100, 110, 125, 150, 175, 200, 225, 250
	HFD6	100	65	HF	70, 80, 90, 100, 150, 175, 200, 225, 250
	HFXD6	100	65	H2	70, 80, 90, 100, 110, 125, 150, 175, 200, 225, 250
400	JXD2	65	–	JD	300, 400
	JXD6 (STD)	65	35	JX	200, 225, 250, 300, 350, 400
	JD6	65	35	J6	200, 225, 250, 300, 350, 400
	HJD6	100	65	H6	200, 225, 250, 300, 350, 400
	HJXD6	100	65	H5	200, 225, 250, 300, 350, 400

Ⓢ xGB interiors are not available as non-feed-thru without sub-feed space.

Ⓢ EDC/CED6 2-pole has limited amps available (20-50A).

# Panelboards

**Table P1-5 - Main Lug Panel Size Selector - Revised P1**

Maximum Ampere rating	Max # Poles FT	Max # Poles NFT	Dimensions in inches (mm)				Weight in Lbs. (kg)	MLO Connectors Suitable for
			Unit Space		Box Height B"			
			FT A	NFT A				
125 (or) 250		18	-	9	26 (661)	90 (41)	(1) #6 AWG - 350 kcmil (CU or AL)	
		30	9	15	32 (813)	105 (48)		
		42	15	21	38 (965)	120 (55)		
		54	21	27	44 (1118)	135 (61)		
		66	27	33	50 (1270)	150 (67)		
400		30	-	15	56 (1423)	120 (55)	AL (2) 1/0 - 250 kcmil or (1) #2 AWG - 600 kcmil CU (2) 1/0 - 4/0 or (1) #2 AWG - 600 kcmil	
		42	15	21	62 (1575)	135 (61)		
		54	21	27	68 (1728)	150 (68)		
		66	27	33	74 (1880)	165 (75)		

**Table P1-6 - Branch Circuit Breakers**

Max. Amp Rating	Breaker Type	Number of Poles	Max. Interrupting Rating (kA)					Available Trip Values	Connections Suitable for Cu or Al
			120V	120/240V	240V	277V	480/277V		
100	BL	1	10	-	-	-	-	15, 20, 25, 30, 35, 40, 45, 50, 55, 60, 70	15-20A #14-#10 AWG Cu #12-#10 AWG Al 25-35A #8-#6 AWG Cu #8-#6 AWG Al 40-50A #8-#6 AWG Cu #8-#4 AWG Al 55-70A #8-#4 AWG Cu #8-#2 AWG Al 80-100A #4-#1/0 AWG Cu #2-#1/0 AWG Al
		2	-	10	-	-	-	15, 20, 25, 30, 35, 40, 50, 60, 70, 80, 90, 100	
		3	-	-	10	-	-	-	
	BLR	2	-	-	10	-	-	15, 20, 30, 40, 50, 60, 70, 90, 100	
		3	-	-	-	-	-	15, 20, 30	
	BL, HID	1	10	-	-	-	-	15, 20, 30	
		2	-	10	-	-	-	15, 20, 30	
	BLH	1	-	22	-	-	-	15, 20, 30, 40, 50, 55, 60, 70	
		2	-	22	-	-	-	15, 20, 30, 40, 50, 60, 70, 90, 100	
		3	-	-	22	-	-	15, 20, 30, 40, 50, 60, 70, 80, 90, 100	
	HBL	1	-	65	-	-	-	15, 20, 30, 40, 50	
		2	-	65	-	-	-	15, 20, 30, 40, 50, 60, 70	
		3	-	-	65	-	-	15, 20, 30, 40, 50, 60, 70, 80, 90, 100	
	BLF2 BLFB	1	10	-	-	-	-	15, 20, 30	
		2	-	10	-	-	-	15, 20, 30, 40, 50, 60	
	BLHF2 BLHFB	1	22	-	-	-	-	15, 20, 30	
		2	-	22	-	-	-	15, 20, 30, 40, 50, 60	
	HBLF2	1	65	-	-	-	-	15, 20, 30	
	BG <sup>①</sup>	2	10	-	-	-	-	15, 20, 30	
		3	-	10	-	-	-	15, 20, 30	
BLE	1	10	-	-	-	-	15, 20, 30		
	2	-	10	-	-	-	15, 20, 30, 40, 50, 60		
BLEH	1	22	-	-	-	-	15, 20, 30		
	2	-	22	-	-	-	15, 20, 30, 40, 50, 60		
BAF	1	10	-	-	-	-	15, 20		
BAFH	1	22	-	-	-	-	15, 20		
BQD	1	-	65	-	14	-	15, 20, 25, 30, 35, 40, 50, 60, 70, 80, 90, 100		
	2	-	65	-	-	14	15, 20, 25, 30, 35, 40, 50, 60, 70, 80, 90, 100		
	3	-	-	65	-	14	15, 20, 25, 30, 35, 40, 50, 60, 70, 80, 90, 100		
125	NGB <sup>②③</sup>	1	100	-	-	25	-	15, 20, 25, 30, 35, 40, 50, 60, 70, 80, 90, 100, 125 <sup>③</sup>	
		2	-	100	100	-	25	15, 20, 25, 30, 35, 40, 50, 60, 70, 80, 90, 100, 125 <sup>③</sup>	
		3	-	100	100	-	25	15, 20, 25, 30, 35, 40, 50, 60, 70, 80, 90, 100, 125 <sup>③</sup>	
	HGB <sup>②③</sup>	1	100	-	-	35	-	15, 20, 25, 30, 35, 40, 50, 60, 70, 80, 90, 100, 125 <sup>③</sup>	
		2	-	100	100	-	35	15, 20, 25, 30, 35, 40, 50, 60, 70, 80, 90, 100, 125 <sup>③</sup>	
		3	-	100	100	-	35	15, 20, 25, 30, 35, 40, 50, 60, 70, 80, 90, 100, 125 <sup>③</sup>	
	LGB <sup>②③</sup>	1	100	-	-	65	-	15, 20, 25, 30, 35, 40, 50, 60, 70, 80, 90, 100, 125 <sup>③</sup>	
		2	-	100	100	-	65	15, 20, 25, 30, 35, 40, 50, 60, 70, 80, 90, 100, 125 <sup>③</sup>	
		3	-	100	100	-	65	15, 20, 25, 30, 35, 40, 50, 60, 70, 80, 90, 100, 125 <sup>③</sup>	

① Two-pole breaker is one phase and neutral. Three-pole is two phases and neutral.

② P1 panel with NGB/HGB/LGB branch devices will not accept BL or BQD frames in the same panel as branch devices.

③ The New Revised P1 (18 circuit 250A only) is limited to 100A per connection (200A per pair) when installing Branch Breakers across from one another.

All other configurations allow 125A per connection max. (250A per pair max.)

**NOTE:** BL, HBL and BQD breakers are mounted in common mountings in 3" or (6) pole increments.

# Panelboards

Circuit Breaker / Lighting and Distribution

Selection

**Table P1-7 – Subfeed Breakers**

Breaker Type	Number of Poles	Max. Interrupting Rating (kA)		Available Trip Values
		240V	480Y/277V	
QR2	2, 3	10	–	100, 110, 125, 150, 175, 200, 225
QRH2	2, 3	25	–	100, 110, 125, 150, 175, 200, 225
HQR2	2, 3	65	–	100, 110, 125, 150, 175, 200, 225
HQR2H	2, 3	100	–	100, 110, 125, 150, 175, 200, 225
ED4	2, 3	65	18	15, 20, 25, 30, 35, 40, 45, 50, 55, 60, 70, 80, 90, 100, 110, 125
ED6 (3-pole) <sup>④</sup>	2, 3	65	25	20, 25, 30, 35, 40, 45, 50, 55, 60, 70, 80, 90, 100, 110, 125
HED4	2, 3	100	42	15, 20, 25, 30, 35, 40, 45, 50, 55, 60, 70, 80, 90, 100, 110, 125
HHED6	2, 3	100	65	15, 20, 25, 30, 35, 40, 45, 50, 55, 60, 70, 80, 90, 100, 110, 125
FXD6	2, 3	65	35	70, 80, 90, 100, 110, 125, 150, 175, 200, 225, 250
FD6	2, 3	65	35	70, 80, 90, 100, 110, 125, 150, 175, 200, 225, 250
HFD6	2, 3	100	65	70, 80, 90, 100, 110, 125, 150, 175, 200, 225, 250
HFXD6	2, 3	100	65	70, 80, 90, 100, 110, 125, 150, 175, 200, 225, 250

**Table P1-8 – Breaker Mounting Kit  
Main or Subfeed Strap Kit w/o Breaker**

Ampere Rating	Breaker Types	Service	Original P1 Catalog No.	Revised P1 Catalog No. <sup>②</sup>
100A	BL, BLH, HBL	1-Phase	MBKBL1	MBKBL1A
		3-Phase	MBKBL3	MBKBL3A
100A	BQD	1-Phase	—	MBKBC1NBA
125A	NGB, HGB, LGB		MBKNB1	
100A	BQD	3-Phase	MBKBC3	MBKBC3NBA
125A	NGB, HGB, LGB		MBKNB3	
125A	ED4, ED6, HED4, HHED6	1-Phase	MBKED1	MBKED1A
		3-Phase	MBKED3	MBKED3A
225A <sup>③</sup>	QR2, QRH2, HQR2, HQR2H	1-Phase	MBKQR1	MBKQR1A
		3-Phase	MBKQR3	MBKQR3A
250A	FXD6, FD6, HFD6, HFXD6	1-Phase	MBKFD1	MBKFD1A
		3-Phase	MBKFD3	MBKFD3A
400A <sup>①</sup>	JXD2, JD6, JXD6, HJD6, HJXD6	1-Phase	MBKJD1	MBKJD1A
		3-Phase	MBKJD3	MBKJD3A

① 400 amp kit is for main only — not allowed for subfeed breaker.

② MBKBFA kit is available to mount BL/BQD/xGB 2-pole or 3-pole in unit space as a "Back-Fed Main". This occupies branch space and reduces circuit count by 2 or 3 positions. (includes Neutral Lug, "MAIN" label and instructions).

③ Although QR is rated 250A, it is limited to 225A in panelboard.

**Table P1-9 – Lug Kits (Main or Feed-Thru)**

Amp Rating	Matl.	Wire Range (includes Neutral)	Service	Original Catalog Number	Revised P1 Catalog Number
250	AL	(1) #6 AWG-350 kcmil (CU or AL)	1 Phase	MLKA1	MLKA1A
			3 Phase	MLKA3	MLKA3A
	CU	(1) #6 AWG-350 kcmil (CU)	1 Phase	MLKC1	MLKC1A
			3 Phase	MLKC3	MLKC3A
400	AL	(2) 1/0 - 250 kcmil or (1) #2 AWG-600 kcmil	1 Phase	4MLKA1	4MLKA1A
			3 Phase	4MLKA3	4MLKA3A
	CU	(2) 1/0 - 4/0 or (1) 1/0 - 600 kcmil	1 Phase	4MLKC1	4MLKC1A
			3 Phase	4MLKC3	4MLKC3A
400	AL	(1) AL 1/0-750 kcmil (2) AL/CU 250kcmil max. [max.(1) 600 kcmil CU wire]	1 Phase	—	4MLKA1B
			3 Phase	—	4MLKA3B

**NOTES:**

① Original P1 kits will not work with Revised P1 interiors if the chart shows different part numbers for each.

② Revised P1 kits will not work with Original P1 interiors if the chart shows different part numbers for each.

③ Field installable Service Entrance Barrier kits are now available as required by UL67 (In COMPAS, you must select Service Entrance Required).

④ ED6/CED6 2-pole has limited amps available (20-50A)

**Table P1-10 – Copper Neutral Lug Kits – 250A**

No. of Circuits	Description	Original P1 Catalog Number	Revised P1 Catalog Number
18	2 or 4 Branch Neutral Strips, 1 Main Neutral Lug, Hardware	CNLK18	Use 30 ckt kit
30		CNLK30	CNLK30A
42		CNLK42	CNLK42A
54, 66		—	CNLK54A

**Table P1-10A – 2/0 Neutral Lug Kits – 250A and 400A**

No. of Circuits	Description	Original P1 Catalog Number	Revised P1 Catalog Number
18	2 or 4 Branch Neutral Strips, Hardware	—	Use 30 ckt kit
30		—	LNLK30A
42		—	LNLK42A
54, 66		—	LNLK54A

**Table P1-11 – 200% Neutral Lug Kits – 250A**

No. of Circuits	Description	Original P1 Catalog Number	Revised P1 Catalog Number
18	2 or 4 Branch Neutral Strips, 2 Main Neutral Lugs, Hardware	2NLK18	Use 30 ckt kit
30		2NLK30	2NLK30A
42		2NLK42	2NLK42A
54, 66		—	2NLK54A

**Table P1-12 – 200% Neutral Lug Kits – 400A**

No. of Circuits	Description	Original P1 Catalog Number	Revised P1 Catalog Number
18	2 or 4 Branch Neutral Strips, 1 Main 600 kcmil Neutral Lug, Hardware	42NLK18	N/A
30		42NLK30	42NLK30A
42		42NLK42	42NLK42A
54, 66		—	42NLK54A

# Panelboards

Circuit Breaker / Lighting and Distribution

Selection

PANELBOARDS 11

**Table P1-13 – Main Breaker Gutter Dimensions Inches (mm)**

Main Breaker	Max. Interrupting Rating (kA)		Neutral Location
	20" wide box	24" wide box	20" wide box
BL, BLH, HBL <sup>②</sup>	8.680 (220) <sup>③</sup>	10.690 (272) <sup>③</sup>	10.500 (267)
BQD <sup>②</sup>	7.880 (200) <sup>③</sup>	9.880 (251) <sup>③</sup>	10.500 (267)
NGB, HGB, LGB <sup>②</sup>	7.770 (197) <sup>③</sup>	9.770 (248) <sup>③</sup>	10.500 (267)
ED4, ED6, HED4	6.125 (156)	8.125 (206)	10.500 (267)
QR2, QRH2, HQR2, HQR2H	6.500 (165)	8.500 (216)	10.500 (267)
FD6, FXD6, HFD6, HFXD6	5.250 (133)	7.250 (184)	10.500 (267)
JD6, JXD6 <sup>①</sup>	15.000 (381)	15.000 (381)	26.500 (674)

<sup>①</sup> JD frame mounted vertically.

**② For Revised P1 with Back-fed Main option, use Side Gutter Wiring Spec Table P1-15.**

<sup>③</sup> These dimensions are for Revised P1 only. See Original P1 cut sheets for valid dimensions if needed (P1 production prior to January 2015).

**Table P1-14 – Main Lug End Gutter Dimensions Inches (mm)**

Amp Rating	End Gutter		Neutral Location	
	20" wide box	24" wide box	20" wide box	24" wide box
125	9.500 (242)	9.500 (242)	10.500 (267)	10.500 (267)
250	9.500 (242)	9.500 (242)	10.500 (267)	10.500 (267)
400	25.500 (648)	25.500 (648)	26.750 (680)	26.750 (680)

**NOTE:** Feed-thru lug and neutral wire bending space is 15.000" and 16.250" respectively on 400A panel.

**Table P1-15 – Side Gutter Wiring Space Inches (mm) (Fig P1-1)**

Reference Letter	Panel Width 20"	Panel Width 24" Optional
A <sup>②</sup>	6.375 (167)	8.375 (213)
B <sup>②</sup>	5.500 (140)	7.500 (191)
C <sup>②</sup>	5.000 (127)	7.000 (178)
D	6.125 (156)	8.125 (206)
E	6.500 (165)	8.500 (216)
F	5.250 (133)	7.250 (184)

<sup>①</sup> Subfeed mounting limit 1 per panel.

**Fig P1-1**

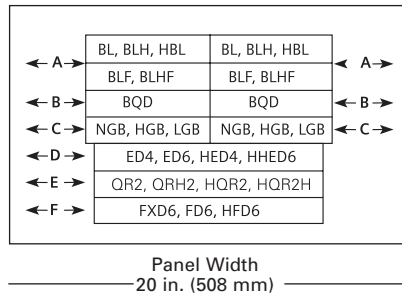

**② For all Revised P1 panels using BL/BQD or xGB breakers as mains in back-fed position, use this chart for wiring space.**



**Feed-Thru (FT)**



**Non-Feed-Thru (NFT)**

## Miscellaneous Parts and Accessories

Catalog #	Description
BK1	Bonding Kit for 400A max. Original P1 Panels
BK1A	Bonding Kit for 400A max. Revised P1 Panels
BK2	Bonding kit for S1/S2 400 & 600
BK3	Bonding kit
IMK1	Interior Adjusting Kit
LPDC01	Directory Card (Pack of 10; ref. 12-1110-01)
LPDC02	Directory Card Holder (Pack of 10; ref. 11-1824-01)
MCHK	Metal Card Holder Kit
NBK03	Number Strips 1–42. Stick-on type (P1 Panel only)
NBK04	Number Strips 43–84. Stick-on type; Use w/ P1 series Panels
NBK05	Number Strips 85–126. Stick-on type; Use w/ P1 series Panels
NBK06	Number Strips 127–168. Stick-on type; Use w/ P1 series Panels
EGK	AL Ground Bus 44 Connections
ECGK	CU Ground Bus 44 Connections
IGK	Insulated AL Ground Bus
ICGK	Insulated CU Ground Bus
SEBKRP1V1 <sup>③</sup>	FD, QJ, QR Service Entrance Barrier Kit (Revised P1)
SEBKRP1V2 <sup>③</sup>	ED Service Entrance Barrier Kit (Revised P1)
SEBKRP1V3 <sup>③</sup>	BQD Service Entrance Barrier Kit (Revised P1) back-fed
SEBKRP1V4 <sup>③</sup>	xGB Service Entrance Barrier Kit (Revised P1) back-fed
SEBKRP1V5 <sup>③</sup>	BL/BQD/xGB Service Entrance Barrier Kit (RP1 in main space)
SEBKRP1P2P3V1 <sup>③</sup>	JD, LD Service Entrance Barrier Kit (RP1, P1, P2, P3)
EWK1	End Wall Kit with Knockouts (20" W x 5.75" DP)
EWK2	End Wall Kit with Knockouts (24" W x 7.75" DP)
EBF1	NEB/HEB Filler Plate
P1SCRWS	Package of 42 breaker mounting screws for P1
DFFP1	1" Branch circuit filler plate (used for BL/BQD/xGB/xGB2/ED blank positions) (suitable for replacing QF3 in P1 thru P5 Panelboards and Switchboards)
P1CONBPHCU <sup>①</sup>	Connector kit – 6 pcs. B-phase Copper
P1CONBPHAL <sup>①</sup>	Connector kit – 6 pcs. B-phase Aluminum
P1CONACPHCU <sup>①</sup>	Connector kit – 6 pcs. A or C-phase Copper
P1CONACPHAL <sup>①</sup>	Connector kit – 6 pcs. A or C-phase Aluminum
MBKQRFK	P1/Revised P1 Filler for 1PH/3PH QR. Horizontal mount only.
ANSI/NEMA PB 1.1-2013	General Instructions for Proper Installation, Operation, and Maintenance of Panelboards Rated 600 Volts or Less (O&M Manual) <sup>②</sup>

<sup>①</sup> Replacement parts only.

<sup>②</sup> PDF can be downloaded (at no cost) and printed at: [www.nema.org/standards/pages/Panelboards.aspx](http://www.nema.org/standards/pages/Panelboards.aspx)

<sup>③</sup> Factory installed and Field installable Service Entrance Barrier kits are now available as required by UL67. (In COMPAS, you must select Service Entrance Required.)



**Example of Back-fed xGB Main breaker installed**

# Panelboards

## Type P1 Panelboard Modifications and Additions

Selection

### Panel Options

#### Enclosures

- Extra gutter to sides or ends of the can
- 24" wide boxes
- Hinged trims
- Door-in-door trims
- Screw to the box trims
- Piano hinge trims
- Painted boxes
- Custom colors
- Increase gauge trims and boxes (See pages 12-13)
- Stainless steel trims and boxes
- Type 1 enclosures (Std 16 Gage / Optional 14 or 12 Gage)
- NEMA 3R/12 enclosures 16 Gauge Can w/ 14 Gauge front)
- NEMA 4 enclosures (14 Gauge only)
- NEMA 4X enclosures (14 Gauge only - 304SS Std, 316SS Optional)

- Special Keyed Locks (Keys are not supplied)
- Panel skirts
- Gaskets between trim and box

TEY TEU1 Cat 60 LL803 LL806	All fit FAS-Latch Front
Yale 47 (NYC) National C413A Beck Lock 7-pin tumbler Southco 1 4 Fastener Corbin 1001 FAB7	Special non-FAS-Latch

\*See page 11-7

### Panel Modifications

#### Enclosures

- Main Bus  
Standard main bus is tin-plated aluminum. For copper main bus, add from the table for each panel. Includes copper neutral cross bar. For copper neutral branch lugs, see miscellaneous.
- Compression lug for MLO<sup>Ⓞ</sup>
- Contactor mains - Mount in 23" enclosure ahead of panel.
  - Asco 920 through 225 amps<sup>Ⓞ</sup>
  - Asco 911 through 150 amps<sup>Ⓞ</sup>
  - Siemens LEN through 30 amps<sup>Ⓞ</sup>
- Branch and main breaker accessories
  - Handle blocks
  - Handle locks
- Feed-thru lugs<sup>Ⓞ</sup>  
Cannot be used in conjunction with SPD/TVSS or subfeed breakers. Do not add height to the panel.

- 200% neutral<sup>Ⓞ</sup>
- Copper lugs, mechanical line and branch neutral<sup>Ⓞ</sup>
- Bus mounted SPD/TVSS<sup>Ⓞ</sup>
- Service entrance labeling
- Factory installed and Field installable Service Entrance Barrier kits are now available as required by UL67
- Grounding of Panelboards  
Ground Bars except for brazed to box are shipped with the panel interior factory mounted.
  - Non-Insulated Equipment Ground Bar – Standard
  - Copper Non-Insulated Ground Bar
  - AL Insulated Equipment Ground Bar
  - CU Insulated Equipment Ground Bar
  - Ground Bar Brazed to Box (recommended for painted boxes)
- Shunt Trip on Main or Branch  
BL<sup>Ⓞ</sup>, BLH<sup>Ⓞ</sup>, HBL<sup>Ⓞ</sup>, BQD<sup>Ⓞ</sup>, xGB<sup>Ⓞ</sup> as branch use  
1" unit space for shunt trip.

Feed-thru Lugs Amp Rating	Type	Connector CU/AL Range
250	AL/CU Mechanical	(1)-#6 AWG-350 kcmil
	CU Mechanical	(1)-#6 AWG-350 kcmil
	AL/CU Compression	(1)-#6 AWG-350 kcmil
400	AL/CU AWG Mechanical	(2)-#1/0 - 250 kcmil or
		(1)-#2 AWG-600 kcmil
	CU	(1)-1/0-600 kcmil (2)-1/0-4/0
	AL/CU Compression	(1) 400-600 kcmil AL (1) 400-500 kcmil CU

**Note:** Specify copper or aluminum cable.

- Ⓞ Do not increase panel or enclosure size.
- Ⓞ Accessories on 1" pole breakers (BL, BQD, xGB, ED) will take 1" unit space.
- Ⓞ External to the panel, supplied in a separate enclosure.

QJ2, QJ2H, QJH2, QR2, QRH2, QHR2, QHR2H, ED2, ED4, ED6, HED4, HED6, HHED6, FD6, FXD6, HFD6
HFXD6, JXD6, JD6, HJD6, HJXD6

- Remote control switches – 480V AC max. mounted in a 23" enclosure to be cable connected to the panel.
- Time Clocks – mounted in a 23" enclosure to be cable connected to the panel. Tork time clock can be supplied and mounted in panelboard cabinet.

Time Clock Information and Options
Time Clock (1- or 2-Pole, Single or Double Throw Contacts, 3-Pole Single Throw) 277V Maximum with Plain Dial
Options:
Astronomical Dial
An Omitting Device
Reserve Power or Carryover
Space and Mounting Provisions Only

# Panelboards

## Type P1 Panelboard Modifications and Additions

Selection

## Compression Lugs

**Table P1-19 – Lugs**

Style	Amp Rating	Breaker Type	Compression Connectors	Box Height Addition
MLO	125	N/A	(1) #6 AWG - 350 kcmil	None
	250			
Main Breaker	400	N/A	(1) 400 - 600 kcmil AL (1) 400 - 500 kcmil CU	None
	125	ED4, ED6, HED4	(1) #14 AWG - 2/0	Box must go to 24" wide
	225	QR2, QRH2, HQR2, HQR2H	(1) #6 AWG - 350 kcmil CU or AL	Box must go to 24" wide for All breakers
	250	FXD6, HFD6	(1) #6 AWG - 350 kcmil CU or AL	Box must go to 24" wide for All breakers

Note: Standard compression lugs used for P1 panels are range taking lugs and require a particular crimping tool (tool is Hubbell/Anderson Versa Crimp VC6 -for 250A) to accommodate the range. Consult factory for information. 200% neutral not available with compression lugs. xGB breakers cannot accommodate compression lugs. (For 400A tool use Hubbell/Anderson Versa Crimp VC6FT/VC7FT - see instruction sheet for details.)

## Enclosure Modifications

### NEMA-4–Water Tight, Dust Tight, Steel Enclosure

(Actual NEMA-4 enclosure is larger than standard Type 1 enclosure. See chart below for reference to approximate actual size.)

**Table P1-20**

Standard Box Height (in inches)	Actual NEMA 4 Enclosure Size		
	H	W	D
32	32	20	8
38	42	30	8
44	48	36	8
56	60	36	10

Note: Larger NEMA 4 enclosures are not available.

### NEMA-4X For Type P1

Water Tight, Dust Tight and Corrosion Resistant  
(consult plant to verify actual enclosure size)

**Table P1-21**

Catalog Number	Enclosure – Stainless Steel Size (inches) (304SS is standard)			Enclosure Fiberglass Size (inches)		
	H	W	D	H	W	D
B4X26	26	20	5.75	36	30	8
B4X32	32	20	5.75	36	30	8
B4X38	38	20	5.75	48	36	12
B4X44	44	20	5.75	48	36	12
B4X50	50	20	5.75	60	36	12
B4X56	56	20	5.75	60	36	12
B4X62	62	20	5.75			
B4X68	68	20	5.75			
B4X74	74	20	5.75			

Note: 316SS is available as an option – must be specified.

## Remote Switch Modifications

**Table P1-22 – Control Power Transformer**

Size	VA Relay
0, 1	50
2	75
3	150
4	250

**Table P1-24 – Remote Control Switch Modification**

Description
Auxiliary Contacts (mounted, not wired)
2-Wire Control

**Table P1-23 – Applications for a Remote Switch**

Switch Type	Modification
920	Mounts in 23" relay cabinet as a main only
LEN	30A mounts in 23" relay cabinet as a main only

### Gauge Steel of Boxes/Fronts, Surface and Flush (see pgs. 11-6 & 11-7)

Dimensions in Inches (mm)		Gauge Steel		
H	W	Box	Front/Door	Type
26-74 (660-1880)	20 (508)	16 <sup>①</sup>	14 <sup>⑥</sup>	Type 1
26-74 (660-1880)	20 (508)	16 <sup>②</sup>	16/14 <sup>②</sup>	Type 3R/12
32-60 (813-1524)	20-36 (508-914)	14 <sup>③</sup>	14 <sup>③</sup>	Type 4
26-74 (660-1879)	20 (508)	14 <sup>④</sup>	14 <sup>④</sup>	Type 4X
36-60 (914-1524)	30-36 (762-914)	N/A <sup>⑤</sup>	N/A <sup>⑤</sup>	Type 4X Non-Metallic

① 16 Gauge is Standard (14 Gauge & 12 Gauge are optional)

② 15 Gauge Steel Can with 14 Gauge Door or Similar Approved Construction

③ No Optional Gauge available

④ 304SS 14 Gauge Std., 316SS 14 Gauge optional

⑤ Sizes do not match Standard Enclosure Sizes - See Table P1-21 - material is non-metallic - No Gauge Specified.

⑥ FAS-Latch is 14 GA only.

Screw-to-Box, Hinge-to-Box, Door-in-Door (14 GA Std./12 GA Std. or 10 GA Optional)

STB/HTB/DND with Piano Hinge (14 GA Std./12 GA Optional)



# Panelboards

## Type P1 Enclosure Details

## Dimensions

### Type 1 Box

Box is symmetrical

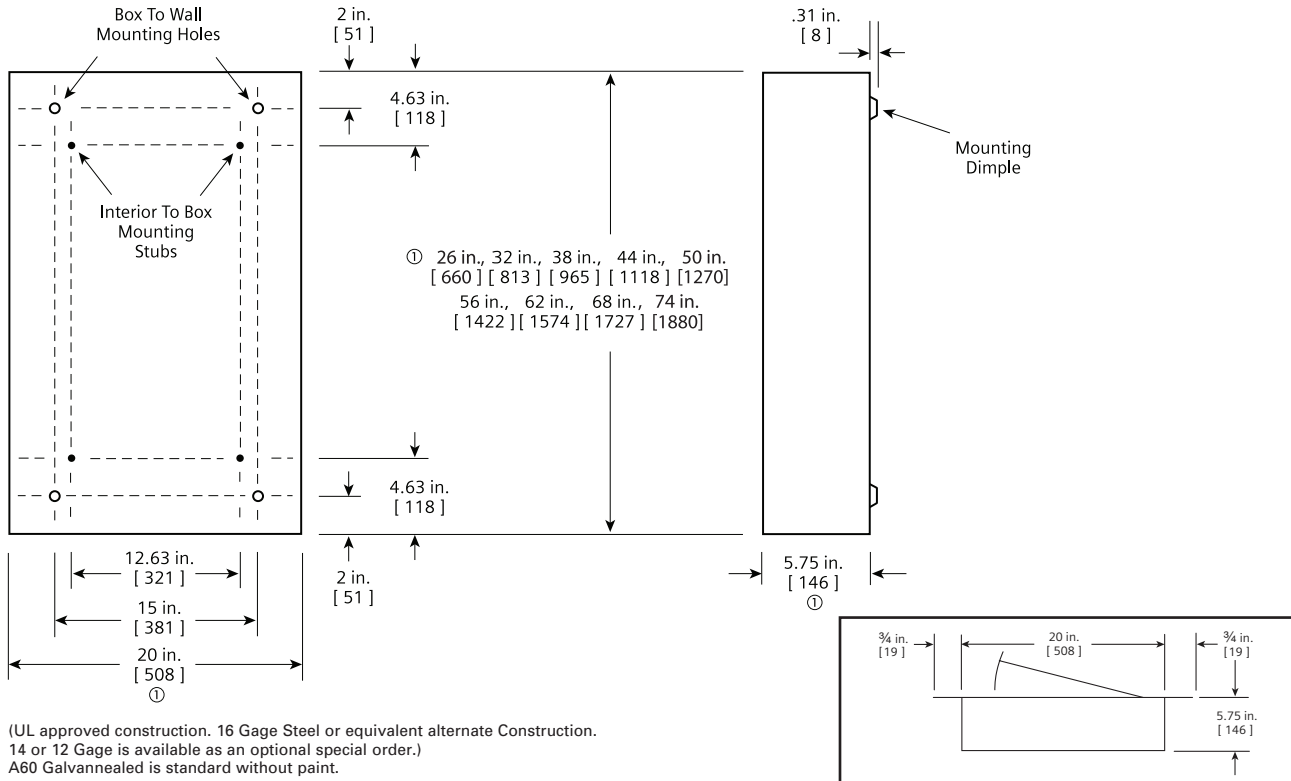

(UL approved construction. 16 Gage Steel or equivalent alternate Construction. 14 or 12 Gage is available as an optional special order.)  
A60 Galvannealed is standard without paint.

### Type 3R and 3R/12 Box

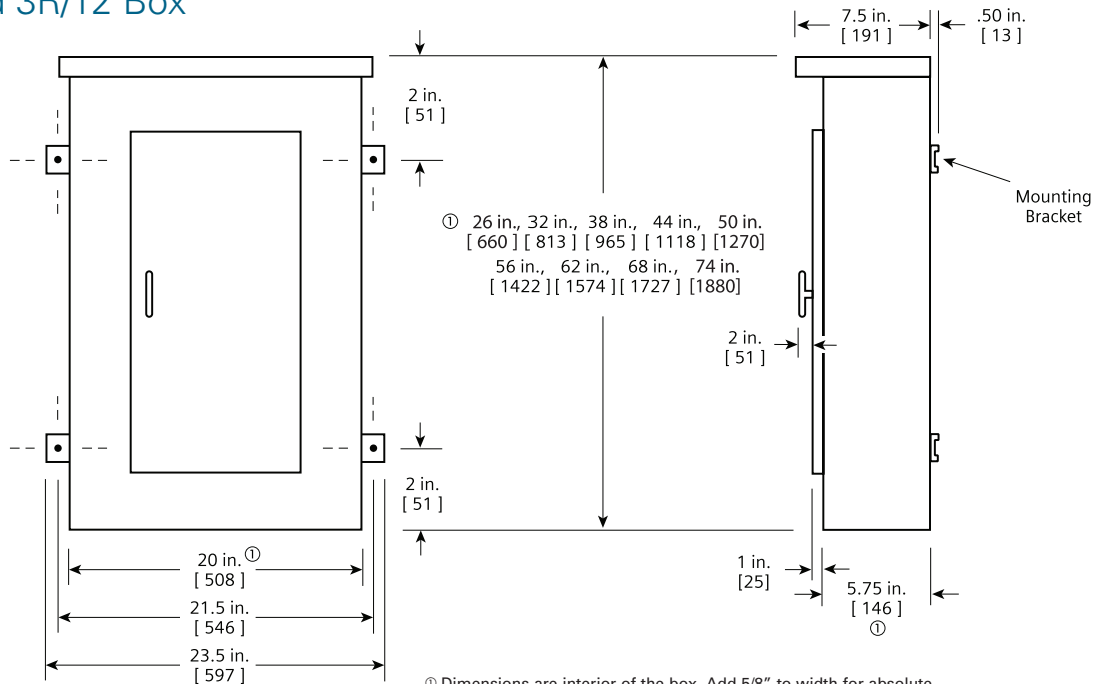

Ⓞ Dimensions are interior of the box. Add 5/8" to width for absolute dimension. Add 1/8" to height for absolute dimension.

(UL approved construction. 16 Gage Steel Can with 14 Gage front or similar approved construction.)  
A60 Galvannealed with ANSI 61 light gray paint is standard.

Dimensions shown in inches and millimeters [ ].

# Panelboards

## Type P2 Panelboards

General

### Features

Flexibility is the hallmark of the P2 panel. This panel offers a wide array of factory-assembled options to meet almost all lighting panel applications. With this design, the ability to mix breaker frames in unit space up to 250 amps will also meet many distribution panel requirements in a much smaller package. Bussing options for the P2 vary from the typical temperature rated to 750 A/Si aluminum to 1000A/Si copper. Standard bussing in the P2 panel is tin-plated. Silver-plated copper is also offered as an option. Integrated time clocks, bus mounted contactors, as mains or sub mains, split bus, and subfeed lugs (up to 400 amp) are just a few of the options of this unique panel.

Like a lighting panel, P2 is set up around 18, 30, 42, 54, 66, 78, and 90 circuit configurations. It will also allow the user to configure the panel to the smallest possible size. The P2 panel starts with 9" of unit space (18 circuits of 1" pole breakers). Breakers mounted in unit space can be mixed and matched to meet customer requirements. All 1" pole breakers (BL, BQD, ED frames) are mounted in 3" or 6" pole increments. Breaker frames, above 125 amps, are mounted in 6" single breaker mountings.

As an example of a minimum panel, (6) 20 amp 1-pole BL breakers (3" of unit space) and a 3-pole 225 amp QJ breaker (6" of unit space) equaling 9" of unit space can be configured in a P2 panel without any extra provisions or space required. FD 250 amp and JD 400 amp breakers are mounted as subfeed breakers outside of unit space.

Another unique feature of the P2 panel is that blank unit space can be added to allow for future expansions or modifications. Any expansions or modifications must be in 3" increments. BL, BQD, and ED frame breakers have 3" or 6" pole kits, and can be mixed in unit space by these increments. Breakers of the same frame can cross from one mounting to another if contiguous. QR frame breakers are mounted in 6" increments for two- and three pole, single mounted units. Changes in the unit space length for BL, BQD, or ED frame breakers require an addition deadfront, center strip kit. Check with sales or the factory for additional unit space kits.

#### Main Lug / Main Breaker

**Enclosure** – Standard Type 1 enclosure is 20" wide x 5.75" deep X. Box Height is determined by main device and unit space. See charts for box height.

**Voltage** – 600V AC max.  
250V DC max.

**Amperage** – 600 amp max.

**Short circuit rating** – 200 KAIC max. symmetrical or equal to the lowest rated device installed unless a series rating is indicated. Panels with subfeed or feed-thru lugs without a main device, circuit breaker or fusible unit, are limited to a three-cycle rating. The three-cycle rating for the P2 panel is limited to 22 KAIC. Note that the main device may be mounted remote from the panel.

**Bussing** – The P2 panel has more options to meet market requirements. The standard bussing is temperature rated aluminum. The rating is per the requirements of UL 67 – the standard for panelboards. All aluminum bussing is tin-plated. Optional bussing for the P2 panel is: 750 A/Si aluminum, temperature rated copper, and 1000 A/Si copper. The copper bus option for this panel is tin-plated.

#### Weight – Approximate

Total panelboard weight when filled with a normal quantity of breakers and accessories is about 3 lbs. (1 kg) per inch (54g per mm) of box height.

### Gauge Steel of Boxes/Fronts, Surface and Flush (see pgs. 11-6 & 11-7)

Dimensions in Inches (mm)		Gauge Steel		
H	W	Box	Front/Door	Type
26-74 (660-1880)	20 (508)	16 <sup>①</sup>	14 <sup>⑥</sup>	Type 1
26-74 (660-1880)	20 (508)	16 <sup>②</sup>	16/14 <sup>②</sup>	Type 3R/12
32-60 (813-1524)	20-36 (508-914)	14 <sup>③</sup>	14 <sup>③</sup>	Type 4
26-74 (660-1879)	20 (508)	14 <sup>④</sup>	14 <sup>④</sup>	Type 4X
36-60 (914-1524)	30-36 (762-914)	N/A <sup>⑤</sup>	N/A <sup>⑤</sup>	Type 4X Non-Metallic

① 16 Gauge is Standard (14 Gauge & 12 Gauge are optional)

② 15 Gauge Steel Can with 14 Gauge Door or Similar Approved Construction

③ No Optional Gauge available

④ 304SS 14 Gauge Std., 316SS 14 Gauge optional

⑤ Sizes do not match Standard Enclosure Sizes - See Table P1-21 - material is non-metallic - No Gauge Specified.

⑥ FAS-Latch is 14 GA only.

Screw-to-Box, Hinge-to-Box, Door-in-Door (14 GA Std./12 GA Std. or 10 GA Optional)

STB/HTB/DND with Piano Hinge (14 GA Std./12 GA Optional)

# Panelboards

## Type P2 Panelboards

## Selection/Dimensions

### Standard Circuit P2 Panels (Neutral Configurations for up to 54 circuits max.)

Table below shows minimum Box Size required for the Unit Space indicated with the Main Option at the top of each Column.

- Adding other options generally will add to the box Height when configured in COMPAS. Also, there may be cost adders with each option.

- The maximum number of 1" circuits supported is show at the bottom of each column in brackets. [54p] = max 54 poles of 1" circuits supported (BL, BQD, ED, xGB).
- Unit space is available in 9", 15", 21", 27", 33", 39", and 45" sizes.
- Within unit space listed, the neutral

will support up to 54 circuits.

- When more than 54 circuits are required, COMPAS will configure with larger Extended Circuit Neutral - see Extended Circuit chart below for minimum box sizes.
- Box sizes available: 26", 32", 38", 44", 50", 62", 68", 74"

"B" Dimension Box Height	P2 Panels with Standard Line Lugs. Unit Space (starting with 9" and adding 6" increments) "A" Dimension															
	Main Lugs			Main Breakers												
	125A	250A	400A 600A	125A Horiz. BL, BQD, xGB, ED	125A Vert. ED <sup>①</sup>	125A Horiz. CED	225A Horiz. QR	225A Vert. QR <sup>①</sup>	250A Horiz. FD	250A Vert. FD <sup>①</sup>	250A CFD	400A JD	400A CJD	600A LD	600A CLD	
26	9	—	—	9	—	—	—	—	—	—	—	—	—	—	—	
32	15	9	—	15	9	9	9	—	—	—	—	—	—	—	—	
38	21	15	9	21	15	15	15	9	9	—	—	—	—	—	—	
44	27	21	15	27	21	21	21	15	15	9	—	—	—	—	—	
50	33	27	21	33	27	27	27	21	21	15	9	9	—	—	—	
56	39	33	27	39	33	33	33	27	27	21	15	15	15	9	—	
62	45	39	33	45	39	39	39	33	33	27	21	21	9	15	9	
68	45	45	39	45	45	45	45	39	39	33	27	27	15	21	15	
74	45	45	45	45	45	45	45	45	45	39	33	33	21	27	21	
	[54p]	[54p]	[54p]	[54p]	[54p]	[54p]	[54p]	[54p]	[54p]	[54p]	[54p]	[54p]	[42p]	[54p]	[42p]	

### Extended Circuit P2 Panels (Neutral Configurations for more than 54 circuits)

When COMPAS configuration has more than 54 circuits, the large neutral configuration is needed. Box size shown is the minimum available without any options.

- Unit space of 33", 39", and 45" are available.
- Unit space will be reduced by selecting some options such as Feed-thru lugs, Surge Protection Devices, and the other Subfeed options.

- In general, vertically mounted mains require 6" more box space than equivalent horizontally mounted mains.
- Neutral configuration supports a maximum of 90 1-pole breakers.

"B" Dimension Box Height	P2 Panels with Standard Line Lugs. Unit Space (starting with 9" and adding 6" increments) "A" Dimension															
	Main Lugs			Main Breakers												
	125A	250A	400A 600A	125A Horiz. BL, BQD, xGB, ED	125A Vert. ED <sup>①</sup>	125A Horiz. CED	225A Horiz. QR	225A Vert. QR <sup>①</sup>	250A Horiz. FD	250A Vert. FD <sup>①</sup>	250A CFD	400A JD	400A CJD	600A LD	600A CLD	
56	33	—	—	33	—	—	33	—	—	—	n/a	—	n/a	n/a	n/a	
62	39	33	33	39	33	33	39	33	—	—	n/a	—	n/a	n/a	n/a	
68	45	39	39	45	39	39	45	39	33	—	n/a	—	n/a	n/a	n/a	
74	45	45	45	45	45	45	45	45	39	33	n/a	33	n/a	n/a	n/a	
	[90p]	[90p]	[90p]	[90p]	[90p]	[90p]	[90p]	[90p]	[78p]	[66p]	n/a	[66p]	n/a	n/a	n/a	

① Note: The vertical main breaker application for ED, QJ, QR, and FD adds 6" of box height.

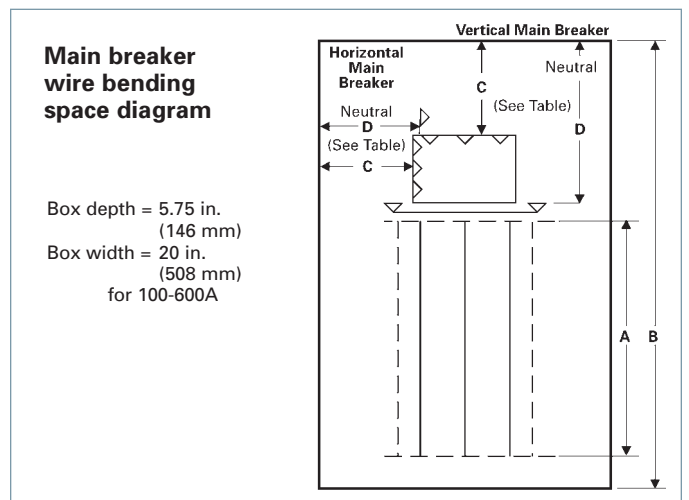
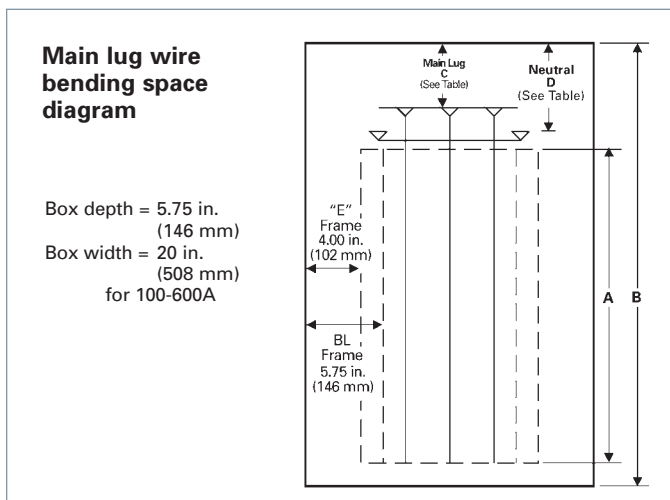

# Panelboards

Type P2 Panelboards

Selection/Dimensions

11  
PANELBOARDS

## Standard Circuit P2 Panels

### Main Breaker Wire Bending

Standard Circuits (up to 54 1" module branch poles)			
Panel Amps	Breaker Frames	C <sup>①</sup>	D <sup>①</sup>
100	BL	5.75	8.00
	BQD	5.13	8.00
125	xGB, xGB2	4.63	8.00
	ED (horiz.)	4.00	8.00
	ED (vert.)	6.56	11.13
225	QR (horiz.)	5.00	7.00
	QR (vert.)	10.06	16.69
250	FD (horiz.)	5.00	7.00
	FD (vert.)	13.25	22.72
400	JD	15.38	25.00
600	LD	15.38	23.00

## Extended Circuit P2 Panels

### Main Breaker Wire Bending

Extended Circuits (more than 54 1" module branch poles)			
Panel Amps	Breaker Frames	C <sup>①</sup>	D <sup>①</sup>
100	BL	5.75	6.56
	BQD	5.13	6.56
125	xGB, xGB2	4.63	6.56
	ED (horiz.)	4.00	6.56
	ED (vert.)	12.56	14.88
225	QR (horiz.)	5.00	6.44
	QR (vert.)	10.06	15.53
250	FD (horiz.)	5.00	5.63
	FD (vert.)	19.25	25.71
400	JD	15.38	23.75
600	LD (54p max)	N/A	N/A

### Main Lug Connectors

Standard Circuits (up to 54 1" module branch poles)			
Panel Amps	Standard Connectors	C <sup>①</sup>	D <sup>①</sup>
125	(1) #14-2/0	6.62	8.19
250	(1) #6 AWG - 350 MCM	11.75	10.72
400	(1) #4 AWG - 600 MCM or (2) #6 - 250 MCM	14.00	13.09
600	(2) #4 AWG - 500 MCM	14.00	11.00

### Main Lug Connectors

Extended Circuits (more than 54 1" module branch poles)			
Panel Amps	Standard Connectors	C <sup>①</sup>	D <sup>①</sup>
125	(1) #14-2/0	12.62	8.91
250	(1) #6 AWG - 350 MCM	17.75	13.69
400	(1) #4 AWG - 600 MCM or (2) #6 - 250 MCM	14.00	14.19
600	(2) #4 AWG - 500 MCM	14.00	14.23

## Branch Breaker Side Gutters Inches (mm)

Reference Letter	Panel Width 20" (508)
A	5.750 (146)
B	5.125 (130)
C	4.000 (102)
D <sup>②</sup>	5.000 (127)
E	4.625 (117)

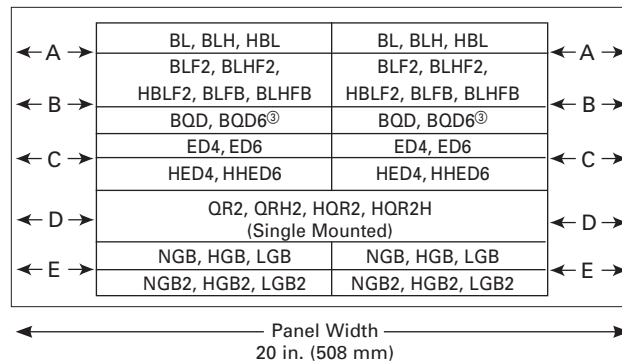

① Refer to diagrams at the bottom of page 11-27.  
② Single branch mounting construction.

③ BQD6 is not UL Listed. Only for CUL and CSA panels.

# Panelboards

## Type P2 Panelboards

Selection

### Main Breaker Selection<sup>①</sup>

Ampere Rating	Breaker Type	Max. Interrupting Rating (kA)			Ref. Catalog No.	Available Trip Values
		240V	480V	600V		
100	BL	10	—	—	BL	15, 20, 25, 30, 35, 40, 50, 60, 70, 80, 90, 100
	HBL	65	—	—	HB	15, 20, 25, 30, 35, 40, 50, 60, 70, 80, 90, 100
	BQD	65	14	—	BQ	15, 20, 25, 30, 35, 40, 50, 60, 70, 80, 90, 100
	BLH	22	—	—	BH	15, 20, 25, 30, 35, 40, 50, 60, 70, 80, 90, 100
125	NGB	100	25	14	NB	50, 60, 70, 80, 90, 100, 110, 125
	HGB	100	35	14	G2	50, 60, 70, 80, 90, 100, 110, 125
	LGB	100	65	14	G3	50, 60, 70, 80, 90, 100, 110, 125
	ED4	65	18	—	E4	50, 60, 70, 80, 90, 100, 110, 125
	ED6 <sup>⑤</sup>	100	25	14	E6	60, 70, 80, 90, 100, 110, 125 (3-pole)
	HED4	100	42	—	H4	50, 60, 70, 80, 90, 100, 110, 125
	HHED6	100	65	18	HA	50, 60, 70, 80, 90, 100, 110, 125
	CED6 <sup>②</sup>	200	200	100	CE	50, 60, 70, 80, 90, 100, 110, 125
	NGB2	100	25	14	G4	50, 60, 70, 80, 90, 100, 110, 125
	HGB2	100	35	22	G5	50, 60, 70, 80, 90, 100, 110, 125
LGB2	100	65	25	G6	50, 60, 70, 80, 90, 100, 110, 125	
225	QR2	10	—	—	QR	100, 110, 125, 150, 175, 200, 225
	QRH2	25	—	—	Q4	100, 110, 125, 150, 175, 200, 225
	HQR2	65	—	—	Q5	100, 110, 125, 150, 175, 200, 225
	HQR2H	100	—	—	Q6	100, 110, 125, 150, 175, 200, 225
	FD6	65	35	18	FD	70, 80, 90, 100, 110, 125, 150, 175, 200, 225
	FXD6	65	35	18	FX	70, 80, 90, 100, 110, 125, 150, 175, 200, 225
	HFD6	100	65	25	HF	70, 80, 90, 100, 110, 125, 150, 175, 200, 225
	HFXD6	100	65	25	H2	70, 80, 90, 100, 110, 125, 150, 175, 200, 225
	CFD6 <sup>②</sup>	200	200	100	CF	70, 80, 90, 100, 110, 125, 150, 175, 200, 225
	250	FD6	65	35	18	FD
FXD6		65	35	18	FX	70, 80, 90, 100, 110, 125, 150, 175, 200, 225, 250
HFD6		100	65	35	HF	70, 80, 90, 100, 150, 175, 200, 225, 250
HFXD6		65	35	25	H2	70, 80, 90, 100, 110, 125, 150, 175, 200, 225, 250
400	JXD6 <sup>②</sup>	65	35	25	JX	200, 225, 250, 300, 350, 400
	JD6 <sup>②</sup>	65	35	35	J6	200, 225, 250, 300, 350, 400
	HJXD6 <sup>②</sup>	100	65	35	H6	200, 225, 250, 300, 350, 400
	HJD6 <sup>②</sup>	100	65	35	H5	200, 225, 250, 300, 350, 400
	SJD6 <sup>②</sup>	65	35	25	SJ	200, 300, 400
	SHJD6 <sup>②</sup>	100	65	35	S2	200, 300, 400
	CJD6 <sup>②</sup>	200	200	100	CJ	200, 300, 400
	SCJD6 <sup>②</sup>	200	200	100	SC	200, 300, 400
600	LXD6 <sup>②</sup>	65	35	25	LX	450, 500, 600
	LD6 <sup>②</sup>	65	35	25	L6	250, 300, 350, 400, 450, 500, 600
	HLXD6 <sup>②</sup>	100	65	35	HL	250, 300, 350, 400, 450, 500, 600
	HLD6 <sup>②</sup>	100	65	35	HO	250, 300, 350, 400, 450, 500, 600
	SLD6 <sup>②</sup>	65	35	25	SL	300, 400, 500, 600
	SHLD6 <sup>②</sup>	100	65	35	S6	300, 400, 500, 600
	CLD6 <sup>②</sup>	200	150	100	CL	300, 400, 500, 600
	SCLD6	200	150	100	C6	300, 400, 500, 600

When an ED4, ED6, HED4, HHED6, QR2, QRH2, HQR2, HQR2H, FD6, HFD6, or FXD6 frame main breaker is required to be vertically mounted, pricing will typically be higher.

### Vertically Mounted Main Breaker (available in 2-pole or 3-pole)

Ampere Rating	Breaker Type(s)	Unit Space (in.)
125	ED4, ED6 <sup>③</sup> , HED4, HHED6	6
225	FXD6, FD6, HFD6 QR2, QRH2, HQR2, HQR2H	6

### Subfeed Breakers (available in 2-pole or 3-pole)

Breaker Type	Mounting Position When Used as Subfeed Breaker	Ampere Ratings For Load	Maximum Interrupting Rating (kA) Symmetrical		
	Vertical		240V AC	480V AC	600V AC
FD6 <sup>④</sup> , FXD6	Twin	70–250	65	35	22
HFD6 <sup>④</sup> , HFXD6	Twin	70–250	100	65	25
JD6 <sup>④</sup> , JXD6	Single	200–400	65	35	25
HJD6 <sup>④</sup> , HJXD6	Single	200–400	100	65	35

① Interchangeable trip main breakers are mounted at top of panel only.  
② Vertically mounted.

③ Twin mounted subfeed breakers are mounted at the bottom of panelboard only and adds 24" to the panel height.

④ Subfeed breaker is mounted at bottom of panelboard only. 400 amp subfeed breaker adds 24" to the panel height. (Only for use with MLO)  
⑤ ED6/CED6 2-pole limited amps available (20-50A)

# Panelboards

## Type P2 Panelboards

Selection

### Branch Circuit Breakers

Max. Amp Rating	Bolt-On Breaker Type	Amps	Availability			Maximum Interrupting Rating (kA)						
			1-Pole	2-Pole	3-Pole	120V AC	120/240V AC	240V AC	277V AC	480V AC	600V AC	250V DC
100	BL	15-60	✓	✓	✓	10	—	—	—	—	—	—
		70	✓	✓	✓	—	10	—	—	—	—	—
		80-100	—	✓	✓	—	—	10	—	—	—	—
	BLH	15-60	✓	✓	✓	—	22	—	—	—	—	—
		70	✓	✓	✓	—	22	—	—	—	—	—
		80-100	—	✓	✓	—	—	22	—	—	—	—
	HBL	15-55	✓	✓	✓	—	65	—	—	—	—	—
		60-100	—	✓	✓	—	65	—	—	—	—	—
	BL, HID	15-30	✓	✓	—	10	10	—	—	—	—	—
	BLR (240V)	15-60	—	✓	—	—	—	10	—	—	—	—
		70-100	—	✓	—	—	—	10	—	—	—	—
	BLE (GFCI)	15-30	✓	✓	—	10	—	—	—	—	—	—
		40-60	—	✓	—	—	10	—	—	—	—	—
	BLEH	20-30	✓	—	—	22	—	—	—	—	—	—
		15-60	✓	✓	—	—	22	—	—	—	—	—
	BLF (GFCI)	15-30	✓	✓	—	10	—	—	—	—	—	—
		40-60	✓	✓	—	—	10	—	—	—	—	—
	BLHF (GFCI)	15-30	✓	✓	—	22	—	—	—	—	—	—
		40-60	✓	✓	—	—	22	—	—	—	—	—
HBLF2 (GFCI)	15-30	✓	—	—	65	—	—	—	—	—	—	
BGL <sup>②</sup>	15-30	—	✓	✓	10	10	—	—	—	—	—	
BAF	15-20	✓	✓	—	10	—	—	—	—	—	—	
BAFH	15-20	✓	✓	—	22	—	—	—	—	—	—	
BQD	15-60	✓	✓	✓	—	65	—	14	—	—	14	
	70-100	✓	✓	✓	—	65	—	—	14	—	14	
125	NGB	15-100	✓	✓	✓	100	100	100	25	—	—	14 <sup>④</sup>
		110-125	—	✓	✓	100	100	100	25	—	—	14 <sup>④</sup>
	HGB	15-100	✓	✓	✓	100	100	100	35	—	—	14 <sup>④</sup>
		110-125	—	✓	✓	100	100	100	35	—	—	14 <sup>④</sup>
	LGB	15-100	✓	✓	✓	100	100	100	65	—	—	14 <sup>④</sup>
		110-125	—	✓	✓	100	100	100	65	—	—	14 <sup>④</sup>
	ED4	15-60	✓	✓	✓	65	—	—	22	—	—	—
		70-100	✓	✓	✓	—	—	65	—	18	—	30
		110-125	—	✓	✓	—	—	65	—	18	—	—
	ED6 <sup>⑤</sup>	20-50	—	✓	✓	—	—	65	—	25	18	30
		70-100	—	✓	✓	✓	—	65	—	25	18	—
		110-125	—	✓	✓	✓	—	65	—	25	18	—
	HED4 <sup>①</sup>	15-60	✓	✓	✓	—	—	65	—	42	18	30
		70-100	✓	✓	✓	—	—	65	—	42	18	—
		110-125	—	✓	✓	—	—	65	—	42	18	—
	HHED6	15-100	✓	✓	✓	—	—	100	—	65	18	—
		110-125	—	✓	✓	—	—	100	—	65	18	—
	NGB2	15-100	✓	✓	✓	100	100	100	25	25	14	14 <sup>④</sup>
		110-125	✓	✓	✓	100	100	100	25	25	14	14 <sup>④</sup>
HGB2	15-100	✓	✓	✓	100	100	100	35	35	22	22 <sup>④</sup>	
	110-125	✓	✓	✓	100	100	100	35	35	22	22 <sup>④</sup>	
LGB2	15-100	✓	✓	✓	100	100	100	65	65	25	25 <sup>⑤</sup>	
	110-125	✓	✓	✓	100	100	100	65	65	25	25 <sup>⑤</sup>	
225	QR2	100-225	—	✓	✓	—	—	10	—	—	—	
	QRH2	100-225	—	✓	✓	—	—	25	—	—	—	
	HQR2	100-225	—	✓	✓	—	—	65	—	—	—	
	HQR2H	100-225	—	✓	✓	—	—	100	—	—	—	

### Branch Device Limitations

Lighting and appliance branch circuit panelboards were included in editions of the National Electrical Code prior to 2008. By application rule (408.15 in all versions of the NEC prior to 2008), lighting and appliance panels are limited to 42 installed circuits. Each over current device pole counts as a circuit.

### Branch Neutral Connections

Wire Range	Max. Number of Connections	Max. Amp <sup>③</sup>
#14-#6	26	65
#14-1/0	28	125
#6-350 kcmil	3	250
(1) #4-600 kcmil or (2) #6-250 kcmil	1	400

① 1-Pole HED 4 15-30A Rated 65kA 35 through 100A Rated 25kA.

② Two pole breaker is one phase and neutral.

Three pole is two phase and neutral.

③ Based on 75 degree copper.

④ 2-pole only (or) two outer poles of 3-pole breaker.

⑤ ED6/CED6 2-pole limited amps available (20-50A).

**NOTE:** QJ/QR Breakers are single mounted in unit space and take 6" of unit space. Limited to (4) per panel max. BL, HBL, BLH and BQD breakers are mounted in common mountings in 3" or (6) pole increments. ED4, ED6, HED4 and HHED6 breakers are mounted in common mountings in 3" or (6) pole increments.

# Panelboards

## Type P2 Panelboards

## Selection

### Main Lugs Only — Examples of basic P2 Panel numbers w/o devices that add to box height.

Max Panel Amp Rating	Max. 1-pole Circuits	Min. Unit space	Standard or Extended Circuit	3Ø4W 208Y/120V		1Ø3W 120/240V		3Ø4W 480Y/277V	
				Panel Number	Box Height Inches Min.	Panel Number	Box Height Inches Min.	Panel Number	Box Height Inches Min.
125	18 30 42 54	9 15 21 27	Standard Circuit Panel	P2C18ML125ATS	26	P2A18ML125ATS	26	P2E18ML125ATS	26
				P2C30ML125ATS	32	P2A30ML125ATS	32	P2E30ML125ATS	32
				P2C42ML125ATS	38	P2A42ML125ATS	38	P2E42ML125ATS	38
	66 78 90	33 39 45	Extended Circuit Panel	P2C54ML125ATS	44	P2A54ML125ATS	44	P2E54ML125ATS	44
				P2C66ML125ATS	56	P2A66ML125ATS	56	P2E66ML125ATS	56
				P2C78ML125ATS	62	P2A78ML125ATS	62	P2E78ML125ATS	62
250	18 30 42 54	9 15 21 27	Standard Circuit Panel	P2C90ML125ATS	68	P2A90ML125ATS	68	P2E90ML125ATS	68
				P2C18ML250ATS	32	P2A18ML250ATS	32	P2E18ML250ATS	32
				P2C30ML250ATS	38	P2A30ML250ATS	38	P2E30ML250ATS	38
	66 78 90	33 39 45	Extended Circuit Panel	P2C42ML250ATS	44	P2A42ML250ATS	44	P2E42ML250ATS	44
				P2C54ML250ATS	50	P2A54ML250ATS	50	P2E54ML250ATS	50
				P2C66ML250ATS	62	P2A66ML250ATS	62	P2E66ML250ATS	62
400	18 30 42 54	9 15 21 27	Standard Circuit Panel	P2C78ML250ATS	68	P2A78ML250ATS	68	P2E78ML250ATS	68
				P2C90ML250ATS	74	P2A90ML250ATS	74	P2E90ML250ATS	74
				P2C18ML400ATS	38	P2A18ML400ATS	38	P2E18ML400ATS	38
	66 78 90	33 39 45	Extended Circuit Panel	P2C30ML400ATS	44	P2A30ML400ATS	44	P2E30ML400ATS	44
				P2C42ML400ATS	50	P2A42ML400ATS	50	P2E42ML400ATS	50
				P2C54ML400ATS	56	P2A54ML400ATS	56	P2E54ML400ATS	56
600	18 30 42 54	9 15 21 27	Standard Circuit Panel	P2C66ML400ATS	62	P2A66ML400ATS	62	P2E66ML400ATS	62
				P2C78ML400ATS	68	P2A78ML400ATS	68	P2E78ML400ATS	68
				P2C90ML400ATS	74	P2A90ML400ATS	74	P2E90ML400ATS	74
	66 78 90	33 39 45	Extended Circuit Panel	P2C18ML600ATS	38	P2A18ML600ATS	38	P2E18ML600ATS	38
				P2C30ML600ATS	44	P2A30ML600ATS	44	P2E30ML600ATS	44
				P2C42ML600ATS	50	P2A42ML600ATS	50	P2E42ML600ATS	50
66 78 90	33 39 45	Extended Circuit Panel	P2C54ML600ATS	56	P2A54ML600ATS	56	P2E54ML600ATS	56	
			P2C66ML600ATS	62	P2A66ML600ATS	62	P2E66ML600ATS	62	
			P2C78ML600ATS	68	P2A78ML600ATS	68	P2E78ML600ATS	68	
66 78 90	33 39 45	Extended Circuit Panel	P2C90ML600ATS	74	P2A90ML600ATS	74	P2E90ML600ATS	74	

### Main Circuit Breaker — Examples of Panel numbers w/o options that add to box height.

Max Panel Amp Rating	Main Type ref	Max. 1-pole Circuits	Unit space	Standard or Extended	1Ø3W 120/240V		3Ø4W 208Y/120V		3Ø4W 480Y/277V	
					Panel Number	Box Height Inches Min.	Panel Number	Box Height Inches Min.	Panel Number	Box Height Inches Min.
100	BL/BQD, xGB, ED horiz.	18 30 42 54	9 15 21 27	Standard Circuit Panel	P2A18BL100ATS	26	P2C18BL100ATS	26	P2E18BQ100ATS	26
					P2A30BL100ATS	32	P2C30BL100ATS	32	P2E30BQ100ATS	32
					P2A42BL100ATS	38	P2C42BL100ATS	38	P2E42BQ100ATS	38
					P2A54BL100ATS	44	P2C54BL100ATS	44	P2E54BQ100ATS	44
					P2A18BQ125ATS	26	P2C18NB125ATS	26	P2E18E4125ATS	26
125	Horiz. Main <sup>Ⓢ</sup>	18 30 42 54	9 15 21 27	Standard Circuit Panel	P2A30BQ125ATS	32	P2C30NB125ATS	32	P2E30E4125ATS	32
					P2A42BQ125ATS	38	P2C42NB125ATS	38	P2E42E4125ATS	38
					P2A54BQ125ATS	44	P2C54NB125ATS	44	P2E54E4125ATS	56
	BQD, xGB, ED	66 78 90	33 39 45	Extended Circuit Panel	P2A66BQ125ATS	56	P2C66NB125ATS	56	P2E66E4125ATS	56
					P2A78BQ125ATS	62	P2C78NB125ATS	62	P2E78E4125ATS	62
					P2A90BQ125ATS	68	P2C90NB125ATS	68	P2E90E4125ATS	68
225	Horiz. Main <sup>Ⓢ</sup>	18 30 42 54	9 15 21 27	Standard Circuit Panel	P2A18QR225ATS	32	P2C18QR225ATS	32	P2E18FX225ATS	38
					P2A30QR225ATS	38	P2C30QR225ATS	38	P2E30FX225ATS	44
					P2A42QR225ATS	44	P2C42QR225ATS	44	P2E42FX225ATS	50
	QR, FD (225A max.)	66 78 90	33 39 45	Extended Circuit Panel	P2A54QR225ATS	50	P2C54QR225ATS	50	P2E54FX225ATS	56
					P2A66QR225ATS	56	P2C66QR225ATS	56	P2E66FX225ATS	68
					P2A78QR225ATS	62	P2C78QR225ATS	62	P2E78FX225ATS	74
250	Horiz. Main <sup>Ⓢ</sup>	18 30 42 54	9 15 21 27	Standard Circuit Panel	P2A90QR225ATS	68	P2C90QR225ATS	68	n/a	n/a
					P2A18FX250ATS	38	P2C18FX250ATS	38	P2E18FX250ATS	38
					P2A30FX250ATS	44	P2C30FX250ATS	44	P2E30FX250ATS	44
	FD	66 78 90	33 39 45	Extended Circuit Panel	P2A42FX250ATS	50	P2C42FX250ATS	50	P2E42FX250ATS	50
					P2A54FX250ATS	56	P2C54FX250ATS	56	P2E54FX250ATS	56
					P2A66FX250ATS	68	P2C66FX250ATS	68	P2E66FX250ATS	68
400	Vert. JD Main <sup>Ⓢ</sup>	18 30 42 54	9 15 21 27	Standard Circuit Panel	P2A78FX250ATS	74	P2C78FX250ATS	74	P2E78FX250ATS	74
					P2A90FX250ATS	n/a	P2C90FX250ATS	n/a	n/a	n/a
					P2A18JX400ATS	50	P2C18JX400ATS	50	P2E18JX400ATS	50
	66 78 90	33 39 45	Extended Circuit Panel	P2A30JX400ATS	56	P2C30JX400ATS	56	P2E30JX400ATS	56	
				P2A42JX400ATS	62	P2C42JX400ATS	62	P2E42JX400ATS	62	
				P2A54JX400ATS	68	P2C54JX400ATS	68	P2E54JX400ATS	68	
600	Vert. LD Main <sup>Ⓢ</sup>	18 30 42 54	9 15 21 27	Standard Circuit Panel	P2A66JX400ATS	74	P2C66JX400ATS	74	P2E66JX400ATS	74
					P2A18LX600ATS	56	P2C18LX600ATS	56	P2E18LX600ATS	56
					P2A30LX600ATS	62	P2C30LX600ATS	62	P2E30LX600ATS	62
	66 78 90	33 39 45	Extended Circuit Panel	P2A42LX600ATS	68	P2C42LX600ATS	68	P2E42LX600ATS	68	
				P2A54LX600ATS	74	P2C54LX600ATS	74	P2E54LX600ATS	74	

General Note: Panel numbers and box sizes are for reference only - COMPAS will configure proper box size needed based on all options.

Ⓢ 125A: for vert ED & horiz. CED add 6" of box height for both Standard and Extended Circuit.  
 Ⓢ 225A: for vert QR & FD add 6" of box height for Standard Circuit. Add 12" of box height for Extended Circuit FD Horizontal.

Ⓢ 250A: for vert FD add 6" of box height; for vert CFD add 12" of box height. (Standard Circuit- see chart for Extended Circuit)  
 Ⓢ 400A: for CJD add 12" of box height for Standard Circuit.  
 Ⓢ 600A: for CLD add 6" of box height for Standard Circuit.

# Panelboards

## Type P2 Panelboard Modifications and Additions

Selection

PANELBOARDS 11

### Enclosures

#### Extra Gutter to Sides or Ends of the Can (Type 1 Only)

Description
6" end gutter 2" side gutter Barrier in gutter (add to extra gutter price – min 4" required) 24" wide
Hinged trims Piano hinged trims Door-in-door trims Screw to the box trims
Trim mounted devices . . . . . See page 11-87 <ul style="list-style-type: none"> <li>• Pilot lights</li> <li>• Toggle switches</li> <li>• Push buttons</li> </ul>
Painted boxes . . . . . See page 11-87 Custom colors . . . . . See painted boxes
Increase gauge trims and boxes . . . . . See page 11-87
Stainless steel trims and boxes, Type 1 . . . . . See page 11-87

#### Meters

(Contact sales for pricing and application engineering for space requirements)

#### Panel Skirts

See page 11-88

#### Special Locks

TEY
TEU1
Cat 60
LL803
LL806
Yale 47 (NYC)
National C413A
Best Lock 7-pin tumbler
Southco 1/4 Fastener
Corbin 1001 FAB7

### Panel Bus Modifications

Main Bus	Catalog Number Addition Amperes Ratings			
	125A	250A	400A	600A
750 A/SI AL.	B	B	B	B
Copper (tin pltd.)	F	F	F	F
Copper (silver pltd.)	E	E	E	E
1000 A/SI Copper (tin pltd.)	G	G	G	G
1000 A/SI Copper (silver pltd.)	H	H	H	H

### Subfeed, Feed-Thru and Split Bus (for 2-pole or 3-pole)

Ampere Rating	Connector Cu/Al Wire Range	Unit Space (inches)
---------------	----------------------------	---------------------

#### Subfeed (Double) Lugs for Main Lug Panelboards Only (400 max)

100/125	(2)—#12 AWG-2/0 kcmil	6
225/250	(2)—#6 AWG-350 kcmil (custom)	6
400	(4)—250 kcmil (custom) (2)—600 kcmil	6

#### Feed-Thru Lugs — Cannot Be Used in Conjunction with TVSS or Subfeed Breakers (200% Neutral not available)

100/125	(1)—#12 AWG-2/0 kcmil	6
225/250	(1)—#6 AWG-350 kcmil	6
400	(2)—250 kcmil (1)—600 kcmil	9
600	(2)—250-500 kcmil	12

#### Split Bus (1 per interior)

Requires feed thru lugs also to feed sub panel section and for space requirements.

100/125	(1)—#12 AWG-2/0 kcmil	6
225/250	(1)—#6 AWG-350 kcmil	6
400	(2)—250 kcmil (1)—600 kcmil	6
600	(2)—250-500 kcmil	6

#### Contactors Mains or Submain\*

See Page 11-86

<ul style="list-style-type: none"> <li>• Asco 920 through 225 amps – adds 12" unit space as main, 15" unit space as submain</li> <li>• External with manufacture supplied enclosure</li> <li>• Siemens LEN through 30 amps - adds 6" as main; 18" for up to 100A submain and 21" for 200A. 7.75" depth cans for up to 100A and 10" depth cans for 200A.</li> </ul>
--------------------------------------------------------------------------------------------------------------------------------------------------------------------------------------------------------------------------------------------------------------------------------------------------------------------------------------------------------------------

\* Call plant for correct can size.

#### Branch and Main Breaker Accessories

See breaker section of this catalog. <ul style="list-style-type: none"> <li>• Handle blocks</li> <li>• Handle locks</li> <li>• Aux. Contacts<sup>Ⓞ</sup></li> <li>• UVR<sup>Ⓞ</sup></li> </ul>
------------------------------------------------------------------------------------------------------------------------------------------------------------------------------------------------

#### Increase Capacity Neutral up to 200% (N/A on Feed Thru Lugs & Subfeed Lugs)

Main Bus Amps
125
250
400
600

See page 11-35 for unit space adders and compatibility with other options.

(Devices mounted and wired to the trim should also have hinged trim specified)

#### Copper MLO Only

Main Bus Amps			
125	250	400	600

#### Bus mounted SPD See Section 10

#### Service Entrance Label

Type P2 Panelboards are factory labeled suitable for use as service entrance equipment when NEC requirements are met. A panelboard cannot have more than six main disconnects, unless it is a lighting and appliance branch panelboard. Lighting and appliance branch panelboards are limited to two main disconnects. Factory installed and Field installable Service Entrance Barrier kits are now available as required by UL67 (In COMPAS, you must select Service Entrance Required).
--------------------------------------------------------------------------------------------------------------------------------------------------------------------------------------------------------------------------------------------------------------------------------------------------------------------------------------------------------------------------------------------------------------------------------------------------------------------------------------------

#### Grounding of Panelboards

Ground Bars except for brazed to box are shipped with the panel interior not factory mounted. <ul style="list-style-type: none"> <li>• Non-Insulated Equipment Ground Bar</li> <li>• Copper Non-Insulated Ground Bar</li> <li>• Al Insulated Equipment Ground Bar</li> <li>• Cu Insulated Equipment Ground Bar</li> <li>• Ground Bar Brazed to Box (Not recommended for painted or NEMA 3R enclosures)</li> </ul>
-------------------------------------------------------------------------------------------------------------------------------------------------------------------------------------------------------------------------------------------------------------------------------------------------------------------------------------------------------------------------------------------------------------------

#### Shunt Trip on Main or Branch

BL, BLH, HBL, NGB, HGB, LGB, NGB2, HGB2, LGB2, ED4, HED4, HHED6 uses 1" unit space for shunt trip. All others may be used on mains or subfeeds. See breaker section for list price adders.

#### Time Clocks

Time clocks may be mounted in a 23" enclosure to be cable connected to the panel. Sangamo, Tork or Paragon time clock can be supplied and mounted in panelboard cabinet. Adds 12" to panel height. Mounts in Sub-area.

Description
Time Clock (1 or 2-pole, single or double throw contacts; 3-pole, single throw) 277V maximum with plain dial
Astronomical dial
An omitting device
Reserve power or carryover
Space and mounting provisions only

<sup>Ⓞ</sup> Accessories on 1" pole breakers (BL, BQD, ED) will take unit space.



## SEM3 System configured in Panelboards

The Siemens SEM3 system can be configured for factory installation in branch circuit monitoring applications using the Siemens COMPAS configuration tool. This option can lower the installation time of the system for the installer while providing a factory warranted solution.

The SEM3 system can be factory installed in unit space in type P2, P4, & P5 Siemens panel boards and SB1, SB2, & SB3 type Siemens switchboards. Please note P1 and P3 configurations are not available at this time and the amount of unit space needed varies depending upon the application. Please note that lead time adders will apply and may vary depending upon the configuration of the system.

## SEM3 for use in Siemens Panelboards

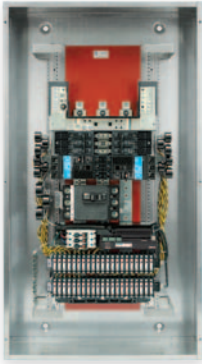

### Type P2: Enclosure

- Available in a NEMA 1, 3R, or 12 rated enclosure.
- Minimum width & depth: 24" width x 5.75" depth
- Height: Up to 74" depending on branch breaker selection
  - Addition of monitoring on some mains (primary and subfeed) may require additional box length. In these cases the box will be increased to the next size available as a standard design.
  - In cases where enclosure size is increased all multi-section panels will be increased to match the largest section.

### Controller



SEM3 controller is mounted in unit space opposite of the feed location specified in COMPAS (i.e., bottom mount for top feed) and will require 3" of unit space. Each controller will be powered by direct tap connection to the panel section bus. Each controller can monitor up to 45 circuits. Applications that require monitoring more than 45 circuits will require additional controllers.

### Current Transformers (CTs)



Five sizes of CTs are available for use in the P2 panel: 50, 125, 250, 400 & 600 amp. All CTs are pre-mounted to a support bracket that attaches to the base rail of the interior of the panel board. Each bracket supports a maximum of 3 CTs and is designed for the breaker selected (brackets are not interchangeable between breaker frames). Each CT will be attached to a data module that is placed in the meter racks.

### Meter Racks



Each meter rack requires 3" of unit space. All meter racks will be installed next to the SEM3 controller in unit space. The COMPAS configuration tool will select the appropriate meter rack configuration according to the user's application and will use the 21 space meter rack as a default option where possible. Only one meter rack (regardless of number of positions) can be installed in 3" of unit space.

**NOTE:** Monitoring of 45 circuits will require 9" of unit space: two 21 position racks and one 3 position rack

# Panelboards

Embedded Micro Metering Module™ (Type P2 Panelboard)

Selection

PANELBOARDS 11

## P2 Devices Enclosure sizes

### Example P2 Panel with SEM3 Type 1 Enclosure (24" Wide x 5.75" Deep)

Enclosure heights are in 6" increments from 26" thru 74".  
Enclosure heights: 26", 32", 38", 44", 50", 56", 62", 68", 74"

The COMPAS configuration tool can provide actual dimensions based on the configuration.  
Example below is largest standard P2 enclosure for factory assembled panel with all small (1") branch breakers installed.

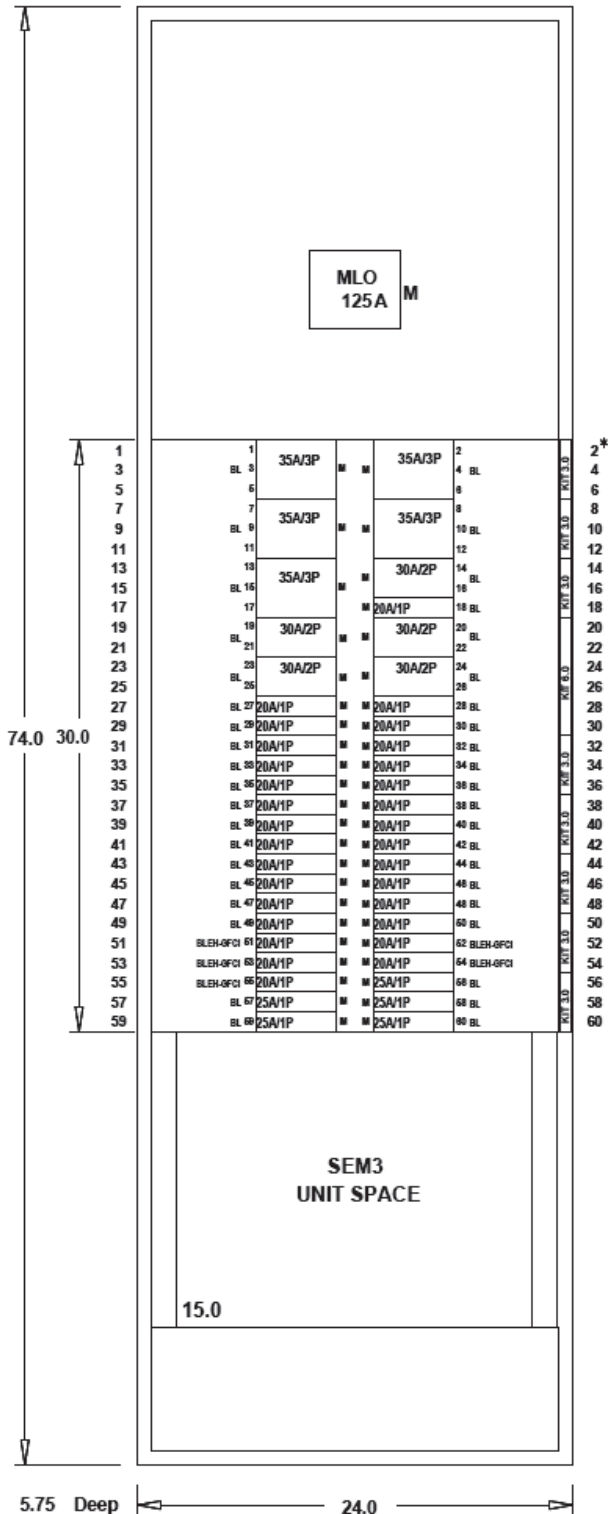

← 24" std. width →

**Main Breaker / Main Lug space varies based on selected options**

Unit space varies based on selected options

**Note:** All circuits do not have to be monitored by SEM3 - user can select any circuits in this space to be monitored.

Based on smallest branch breakers and a 3-phase main being monitored. There is a maximum of 63 circuits that can be monitored with the configuration shown. Some selections of main breakers and other subfeed options could limit this further.

In this situation there is 30" of unit space available - so 60 branch circuits could be monitored. If monitoring the main three additional circuits could be monitored with a total of 63 circuits.

This requires two controllers and three 21 position racks using 15" of unit space. - see below -

**SEM3 space varies by number of circuits monitored - this uses unit space.**

- == > 6" of space for up to 21 circuits monitored one controller and one 21-pos rack
- == > 9" of space for up to 42 circuits monitored one controller and two 21-pos racks
- == > 12" of space for up to 45 circuits monitored one controller and two 21-pos racks plus one 3-pos rack
- == > 15" of space for up to 63 circuits monitored two controllers and three 21-pos racks

**Note:** If subfeed space is needed - it will take away from available unit space.

# Panelboards

## Type P2 Panelboard Standard Modifications and Additions

Selection

### Box Size Additions for Optional Features

Options	Main Lugs				Main Breakers											
	125A	250A	400A	600A	125A Horiz. BL, BQD, ED, xGB	125A Horiz. CED	125A Vert. ED	225A Horiz. QR	225A Vert. QR	225A Horiz. FD	250A Vert. FD	250A Vert. CFD	400A JD	400A CJD	600A LD	600A CLD
*Min. Box Size	26"	32"	38"	38"	26"	32"	32"	32"	38"	38"	44"	50"	50"	62"	56"	62"
200% Neutral (lug type)	0	0	6 (all)	6 (all)	0	0	0	N/A	0	N/A	0	0	0	0	0	0
Std. Lugs (100% Neut. PNL)	0	0	0	0	0	0	0	0	0	0	0	0	0	0	0	0
CU Lugs (100% Neut. PNL)	6	6	6	0	N/A	N/A	0	N/A	0	N/A	0	0	0	0	0	0
Comp Lugs (100% Neut. PNL)	6	6	6	6	N/A	N/A	0	N/A	0	N/A	0	0	0	0	0	0
Feed-thru Standard Lugs	6	6	12	12	6	6	6	N/A	6	N/A	6	6	12	12	12	12
Feed-thru Cu Lugs	6	6	12	N/A	N/A	N/A	6	N/A	6	N/A	6	6	12	12	N/A	N/A
Feed-thru Comp Lugs	6	12	12	N/A	N/A	N/A	6	N/A	6	N/A	12	12	12	12	N/A	N/A
Subfeed Standard Lugs	0	6	6	N/A	—	—	—	—	—	—	—	—	N/A	—	—	—
Split Bus	6	6	6	6	6	6	6	N/A	6	N/A	6	6	6	6	6	6
(1) FD Subfeed (Horizontal Mtg.)	N/A	12	12	12	N/A	N/A	N/A	N/A	N/A	12	12	12	12	12	12	12
(2) FD Subfeed (Vertical Mtg.)	N/A	24	24	24	N/A	N/A	N/A	N/A	N/A	24	24	24	24	N/A	N/A	N/A
SPD	12	12	12	12	12	12	12	12	12	12	12	12	12	12	12	12

Split bus is paired with feed-thru lugs by default. Feed-thru lugs are to feed the section after the split.

**NOTE:** N/A = OPTION NOT AVAILABLE

\*Min. Box Size, corresponding to 9" of Unit Space.

### Compression Lugs

Style	Amp Rating	Breaker Type	Compression Connectors	Box Height Addition
MLO	125	N/A	(1)#6 - 350 kcmil Al/Cu	6
	250	N/A	(1)#6 - 350 kcmil Al/Cu	6
	400	N/A	(1) 400 - 600 kcmil Cu or (2)#6 - 350 kcmil Al/Cu	6
	600	N/A	(2)#6 - 350 kcmil Cu or Cu/Al or 400 - 600 kcmil Al/Cu	6
Main Breaker	100	ED4, ED6, HED4 HHED6, CED6 <sup>Ⓞ</sup>	(1)#14-2/0 AWG Cu or Al	Box must go to 24" wide on CED6 breaker only Add 6" to box height for NØ
	225	QR2, QRH2, HQR2, HQR2H	(1)#6 AWG - 350 kcmil Cu or Al	Box must go to 24" wide
	250	FXD6, HFD6, CFD6	(1)#6 AWG - 350 kcmil Cu or Al	Box must go to 24" wide for all breakers Requires an additional 6.0" box height
	400	JD6, JXD6, HJD6, CJD6, SJD6, SHJD6, SCJD6	(2)#1/0 AWG - 500 kcmil Cu or Al	9
	600	LD6, LXD6, HLD6, CJD6, SLD6, SHLD6, SCLD6	(2)#2/0 AWG - 500 kcmil Cu or Al	6

### Alternate Lugs

Style	Amp Rating	Breaker Type	Standard AL Connectors	Box Height Addition
MLO	400	N/A	(1) 250 - 750 kcmil or (2)#3/0 AWG - 250 kcmil Cu or Al	6
Main Breaker	400	JD6, JXD6, HJD6, CJD6, SJD6, SHJD6, SCJD6	(1)#4/0 AWG - 750 kcmil Cu or Al	6

<sup>Ⓞ</sup> Not available for feed thru lug.

# Panelboards

## Type P2 Panelboard Connector Modifications

Selection

## Enclosure Modifications

Description
20" Panel Width NEMA 3R enclosures NEMA 3R/12 enclosures Gasket between trim and box (Type 1)
24" Panel Width NEMA 3R enclosures NEMA 3R/12 enclosures <sup>①</sup> Gasket between trim and box (Type 1)

**NEMA-4—Water Tight, Dust Tight, Steel Enclosure<sup>②</sup>** (Actual NEMA-4 enclosure is larger than standard Type 1 enclosure. See chart below for reference to approximate actual size.)

Standard Box Height (in inches)	Actual NEMA 4 Enclosure Size <sup>②</sup>		
	H	W	D
32	32	20	8
38	42	30	8
44	48	36	8
56	60	36	10

NOTE: Larger NEMA 4 enclosures are not available.

**NEMA-4X—Water Tight, Dust Tight and Corrosion Resistant<sup>③</sup>**  
(consult plant for actual enclosure size)

Catalog Number	Enclosure – Stainless Steel Size (inches) (304SS is standard)			Enclosure – Fiberglass Size (inches)		
	H	W	D	H	D	W
B4X26	26	20	5.75	36	30	8
B4X32	32	20	5.75	36	30	8
B4X38	38	20	5.75	48	36	12
B4X44	44	20	5.75	48	36	12
B4X50	50	20	5.75	60	36	12
B4X56	56	20	5.75	60	36	12
B4X62	62	20	5.75			
B4X68	68	20	5.75			
B4X74	74	20	5.75			

NOTE: 316SS is available as an option - must be specified.

- ① 16 Gauge Cans w/ 14 Gauge Front)
- ② 14 Gauge only
- ③ 14 Gauge only - 304SS Std, 316SS Optional)

## Gauge Steel of Boxes/Fronts, Surface and Flush (see pgs. 11-6 & 11-7)

Dimensions in Inches (mm)		Gauge Steel		
H	W	Box	Front/Door	Type
26-74 (660-1880)	20 (508)	16 <sup>①</sup>	14 <sup>②</sup>	Type 1
26-74 (660-1880)	20 (508)	16 <sup>②</sup>	16/14 <sup>②</sup>	Type 3R/12
32-60 (813-1524)	20-36 (508-914)	14 <sup>③</sup>	14 <sup>③</sup>	Type 4
26-74 (660-1879)	20 (508)	14 <sup>④</sup>	14 <sup>④</sup>	Type 4X
36-60 (914-1524)	30-36 (762-914)	N/A <sup>⑤</sup>	N/A <sup>⑤</sup>	Type 4X Non-Metallic

- ① 16 Gauge is Standard (14 Gauge & 12 Gauge are optional)
- ② 15 Gauge Steel Can with 14 Gauge Door or Similar Approved Construction
- ③ No Optional Gauge available
- ④ 304SS 14 Gauge Std., 316SS 14 Gauge optional
- ⑤ Sizes do not match Standard Enclosure Sizes - See Table P1-21 - material is non-metallic - No Gauge Specified.
- ⑥ FAS-Latch is 14 GA only.
- Screw-to-Box, Hinge-to-Box, Door-in-Door (14 GA Std./12 GA Std. or 10 GA Optional)
- STB/HTB/DND with Piano Hinge (14 GA Std./12 GA Optional)

# Panelboards

## Type P2 Panelboard Kits and Accessories

Selection

### Standard Enclosures

Box Height Inches	Catalog Number				
	Type 1 Standard Trim			Type 3R	Type 3R/12 ①
	Box	Surface	Flush		
26	B26	S26B	F26B	NR26	WP26
32	B32	S32B	F32B	NR32	WP32
38	B38	S38B	F38B	NR38	WP38
44	B44	S44B	F44B	NR44	WP44
50	B50	S50B	F50B	NR50	WP50
56	B56	S56B	F56B	NR56	WP56
62	B62	S62B	F62B	NR62	WP62
68	B68	S68B	F68B	NR68	WP68
74	B74	S74B	F74B	NR74	WP74

① Same as Type 3R with Gasket added for Type 12 Spec.

### Options For Type 1 Trims

Items must be ordered as manual line item on Spartanburg

Hinged trim – Replace "B" suffix with "H"

Door-in-door – Replace "B" suffix with "D"

Screw to Box - Replace "B" suffix with "C"

Metal card holder - Add "M" suffix on all trims

### Option For 24" Wide Enclosures with Equal Gutter on Both Sides (Excludes NEMA 3R)

24" wide with equal gutter on both sides - Add "24" as prefix

### Breaker Kits and Accessories

Kit Number	Description	Contents
BBKB32 (P2/P3)	BL/BQD 6-pole 3" branch breaker kit	Kit contains top barrier, (3) A/C connectors, (1) B connector, hardware
BBKED32 (P2/P3)	ED 6-pole 3" branch breaker kit	Kit contains breaker support, inter-phase barriers, (3) A/C connectors, (1) B connector, hardware
BBKNB32 (P2/P3)	xGB 6-pole 3" branch breaker kit	Kit contains top barrier, (3) A/C connectors, (1) B connector, hardware
BBKGB32 (P2/P3)	xGB2 6-pole 3" branch breaker kit	Kit contains top barrier, (3) A/C connectors, (1) B connector, hardware
BBKQ1 (P2)	QR branch breaker kit for 2 and 3-pole single mount	Kit to contain all connectors and cover plates necessary to mount both 2 and 3-pole QR breakers
BBKQR1 ①	P2 branch BKR strap kit for single QR 1-phase/3-phase.	Kit to contain all connectors and cover plates necessary to mount both 2 and 3-pole breakers
DFK1	BL, BQD, ED deadfront kit for 1" pole breakers	Center strips 3", 6", 9", 12", 15", 18", 21" plus mounting hardware
DFFP3	Deadfront filler 3"	3" empty space filler and hardware
DFFP6	Deadfront filler 6"	6" empty space filler and hardware
BNK2	Branch neutral (P2)	Three tier lug with mounting hardware to increase neutral capacity
P2BK1	P2 250A max. Bonding Kit	Bonding strap and hardware
P2BK2	P2 400A max. Bonding Kit	Bonding strap and hardware
P2BK3	P2 600A max. Bonding Kit	Bonding strap and hardware
BBKQRP1FK	P2 Filler for QR. Horizontal or vertical mount. 1-phase/3-phase.	Kit contains all cover plates necessary to change from QJ to QR both 2 and 3-pole breakers.
SEBKP2V1③	BL, BQD Main Service Entrance Barrier (P2 only)	Kit contains barrier, mounting brackets, and hardware
SEBKP2V2③	xGB Main Service Entrance Barrier (P2 only)	Kit contains barrier, mounting brackets, and hardware
SEBKP2V3③	FD, QJ, QR Horizontal Main Service Entrance Barrier (P2, P2 with SEM3, P3)	Kit contains barrier, mounting brackets, and hardware
SEBKP2V4③	FD, QJ, QR Vertical Main Service Entrance Barrier (P2, P2 with SEM3)	Kit contains barrier, mounting brackets, and hardware
SEBKP2V5③	ED Horizontal Main Service Entrance Barrier (P2, P2 with SEM3)	Kit contains barrier, mounting brackets, and hardware
SEBKP2V6②③	ED Vertical Main Service Entrance Barrier (P2, P2 with SEM3)	Kit contains barrier, mounting brackets, and hardware
SEBKP1P2P3V1③	JD, LD Service Entrance Barrier Kit (RP1, P1, P2, P3)	Kit contains barrier, mounting brackets, and hardware

① Although QR is rated 250A, it is limited to 225A in panelboard.

② Two kits required for P2 Extended circuit Panels

③ Factory installed and Field installable Service Entrance Barrier kits are now available as required by UL67. (In COMPAS, you must select Service Entrance Required.)

## Type P1, P2, and P3 Panelboards

### Miscellaneous Parts and Accessories

Catalog No.	Description	Catalog No.	Description
EGK	AI Ground Bus 44 Connections	NBK6	Number Strips 86-168 (snap-in type, P2/P3 panels)
P2BK1	P2 250A Bonding Kit	NBK7	Number Strips 169-210 (snap-in type, P2/P3 panels)
P2BK2	P2 400A Bonding Kit	NBK8	Number Strips 211-252 (snap-in type, P2/P3 panels)
P2BK3	P2 600A Bonding Kit	ECGK	Cu Ground Bus 44 Connections
IMK1	Interior Adjusting Kit	IGK	Insulated AI Ground Bus
LPDC01	Directory Card (Pack of 10; ref. 12-1110-01)	ICGK	Insulated Cu Ground Bus
LPDC02	Directory Card Holder (Pack of 10; ref. 11-1824-01)	EWK1	End Wall Kit with Knockouts (20" W x 5.75" DP)
ANSI/NEMA PB 1.1-2013	General Instructions for Proper Installation, Operation, and Maintenance of Panelboards Rated 600 V or Less (O&M Manual)①	EWK2	End Wall Kit with Knockouts (24" W x 7.75" DP)
NBK3	Number Strips 1-42 (snap-in type, P2/P3 panels)	DFFP1	1" Filler Plate – (used for BL/BQD/xGB/xGB2/ED blank positions) (suitable for replacing QF3 in P1 thru P5 Panelboards and Switchboards)
NBK4	Number Strips 43-84 (snap-in type, P2/P3 panels)	EBF1	NEB/HEB Filler Plate
NBK5	Number Strips 85-126 (snap-in type, P2/P3 panels)		

① PDF can be downloaded (at no cost) and printed at this location: <http://www.nema.org/standards/pages/Panelboards.aspx>

# Panelboards

## Type P2 Panelboards

## Dimensions

PANELBOARDS 11

### Type 1 Box

Box is symmetrical

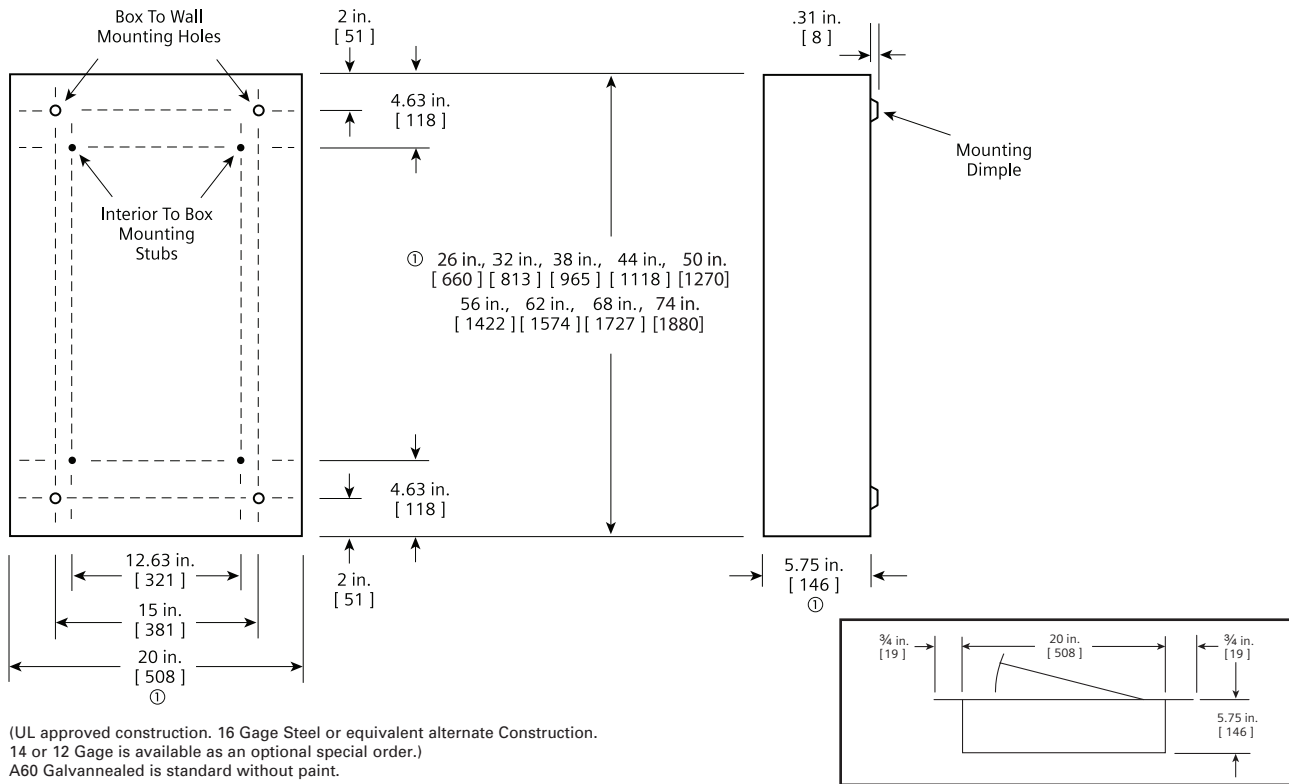

(UL approved construction. 16 Gage Steel or equivalent alternate Construction. 14 or 12 Gage is available as an optional special order.)  
A60 Galvannealed is standard without paint.

Flush Mounting

### Type 3R and 3R/12 Box

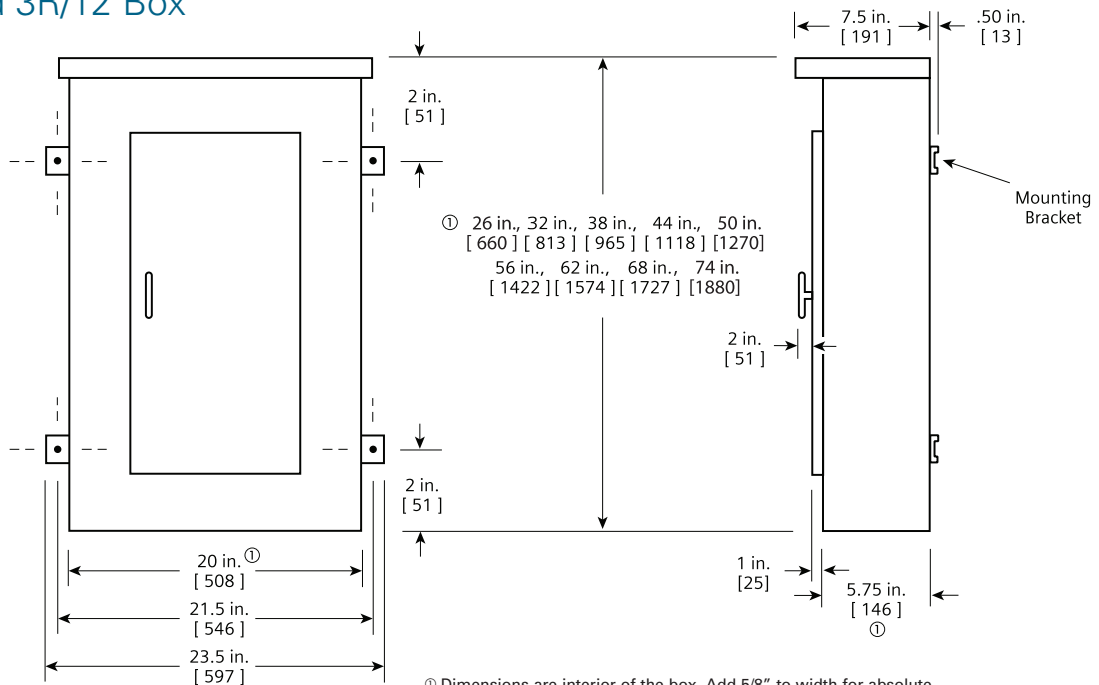

Ⓢ Dimensions are interior of the box. Add 5/8" to width for absolute dimension. Add 1/8" to height for absolute dimension.

Dimensions shown in inches and millimeters [ ].

(UL approved construction. 16 Gage Steel Can with 14 Gage front or similar approved construction.)  
A60 Galvannealed with ANSI 61 light gray paint is standard.

# Panelboards

## Type P3 Panelboards

General

### Features

Another innovation from Siemens is the P3 panel. It is a smaller, footprint distribution panel to fit a large number of applications that require more (or larger) branch devices than the lighting panel class offer. This panel offers a wide array of factory-assembled options, and has the ability to mix breaker frames in unit space up to 250 amps. Bussing options for the P3 vary from the standard temperature aluminum to temperature rated copper, 750 A/Si aluminum, and 1000A/Si copper designs. All bussing in the P3 panel is tin-plated as a standard. Silver-plated copper is offered as an option on a copper bus. Integrated time clocks, bus mounted contactors, as mains or sub mains, split bus and subfeed lugs (up to 400 amp) are just a few of the options of this unique panel.

The P3 panel configurations, defined by the unit space, allow for a given amperage, main device, and box height. The P3 panel starts with a 56" high box. Breaker unit space can be mixed and matched to meet customer requirements. All 1" pole breakers (BL, BQD, ED, xGB frames) are mounted in 3" or 6" pole increments. Breaker frames, above 125 amps, are mounted in 6" single or twin breaker mountings. QR (225A max) and 3VA52 (250A max) breakers are twin mounted in 6" unit space. A max of 6 total large frame breakers are allowed in unit space. Any subfeed breakers do not reduce this. For example, FD 250 amp and JD 400 amp breakers are mounted as subfeed breakers outside of unit space.

Like other distribution panels, the P3 panel can have blank space added into the panel to allow for future expansions or modifications. Any expansions or modifications must be in 3" increments. BL, BQD and ED frame breakers have 3" or 6-pole kits and can be mixed in unit space by these increments. Breakers of the same frame can cross from one mounting to another if contiguous. xGB frame breakers cannot be mixed with other frame types. Any expansion or modification must be in 3" increments also. QR frame breakers are mounted in 6" increments for two and three pole single and twin mounted units. Changes in the unit space length for BL, BQD, xGB, or ED frame breakers require an additional deadfront center strip kit. Check with sales or the factory for additional unit space kits.

### Main Lug/Main Breaker

**Enclosure** – Standard Type 1 enclosure is 24" wide x 7.75" deep. X Box Height is determined by main device and unit space. See charts for box height.

**Voltage** – 600V AC max.  
250V DC max.

**Amperage** – 800 amp max.

**Short Circuit Rating** – 200 Kaic max. symmetrical or equal to the lowest rated device installed unless a series rating is indicated. Panels with subfeed or feed-thru lugs without a main device, circuit breaker or fusible unit, are limited to a three-cycle rating. The three-cycle rating for the P3 panel is limited to 22 Kaic. Note that the main device may be mounted remote from the panel.

**Bussing** – The P3 panel has more options to meet market requirements. The standard bussing is temperature rated aluminum. The rating is per the requirements of UL 67 – the standard for panelboards. All aluminum bussing is tin-plated. Optional bussing for the P3 panel is: 750 A/Si aluminum, temperature rated copper, and 1000 A/Si copper. The copper bus option for this panel is tin-plated.

### Weight – Approximate

Total panelboard weight when filled with a normal quantity of breakers and accessories is about 5 lbs. (1 kg) per inch (54g per mm) of box height.

### Gauge Steel of Boxes Fronts, Surface & Flush

Dimensions in inches (mm)		Gauge Steel	
Width	Height	Box	Front
24" (610)	56 - 80" (1422, 2032)	#16	#14

# Panelboards

## Type P3 Panelboards

## Selection/Dimensions

### Panel Unit Space To Box Height Requirements

"B" Dimension Box Height	P3 Panels With Standard Line Lugs. Unit Space (starting with 9" and adding 6" increments) "A" Dimension										
	Main Lugs				Main Breakers						
	250A	400A	600A	800A	250A Horiz. FD	250A Vert. FD	250A CFD	400A JD	400A CJD	600A LD	600A CLD
56	27	21	21	21	21	15	9	9	—	9	—
62	33	27	27	27	27	21	15	15	9	15	9
68	39	33	33	33	33	27	21	21	15	21	15
74	45	39	39	39	39	33	27	27	21	27	21
80	45	45	45	45	45	39	33	33	27	33	27

### Main Breaker Wire Bending

Breaker Frame	C	E	F
FD Horiz.	7.25	—	20.13
FD Vert.	—	12.25	25.38
CFD	—	13.63	31.38
JD	—	15.63	29.38
CJD	—	14.75	35.38
LD	—	14.75	29.38
CLD	—	14.00	35.38

### Main Lug Wire Bending

Panel Amps	Standard Connectors	C	D
250	(1) #6 AWG - 350 kcmil	10.75 ①	13.50
400	(2) #3/0 AWG - 250 kcmil or (1) 600 kcmil	16.00	17.88
600	(2) #3/0 AWG - 500 kcmil	16.00	17.88
800	(2) 600 kcmil	16.00	17.88

① This lug is removable.

### Main Breaker Wire Bending Diagram

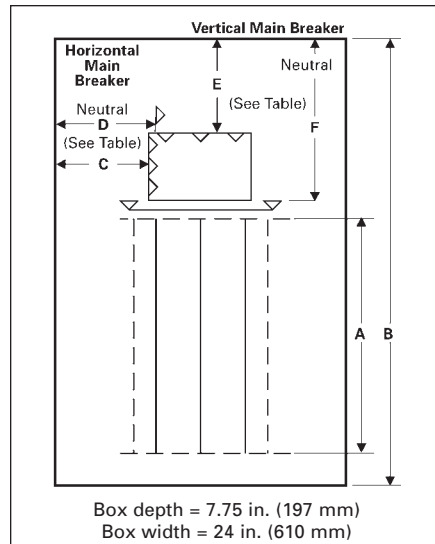

Main Breaker Wire Bending

### Main Lug Wire Bending Diagram

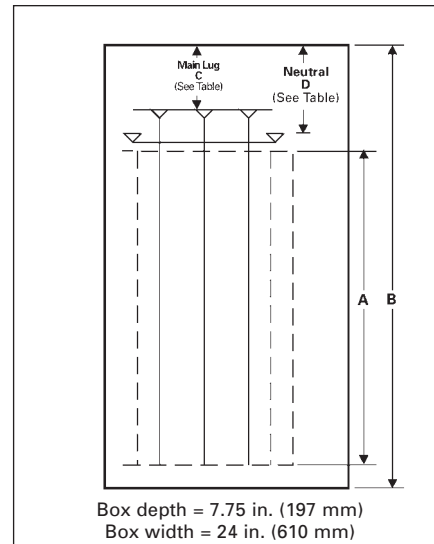

Main Lug Wire Bending

### Branch Breaker Side Gutters Inches (mm)

Reference Letter	Panel Width 24" (609)
A	7.750 (197)
B	7.125 (181)
C	6.000 (152)
D①	7.000 (178)
E	5.000 (127)
F	6.625 (168)
G	5.500 (140)

### Branch Breaker Wire Bending Diagram

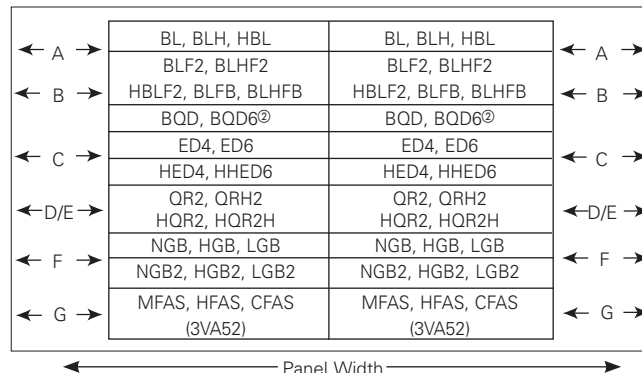

Branch Breaker Side Gutters

① Single branch mounting construction.  
② BQD6 is not UL Listed. Only for CUL and CSA panels.



# Panelboards

## Type P3 Panelboards

Selection

### Alternate Main Breakers

Ampere Rating	Breaker Type	Maximum Interrupting Rating (kA)			Ref. Catalog Number	Available Configurations <sup>②</sup>			Available Trip Values
		240V	480V	600V		240V AC	480V AC	600V AC	
250	FD6	65	35	18	FD	STD	STD	STD	70, 80, 90, 100, 110, 125, 150, 200, 225, 250
	FXD6	65	35	18	FX	STD	STD	STD	70, 80, 90, 100, 110, 125, 150, 200, 225, 250
	HFD6	100	65	25	HF	ADD	ADD	ADD	70, 80, 90, 100, 110, 125, 150, 200, 225, 250
	HFXD6	100	65	25	H2	ADD	ADD	ADD	70, 80, 90, 100, 110, 125, 150, 200, 225, 250
	CFD6 <sup>①</sup>	200	150	100	CF	ADD	ADD	ADD	70, 80, 90, 100, 110, 125, 150, 200, 225, 250
400	JXD6 <sup>①</sup>	65	35	25	JX	STD	STD	STD	200, 225, 250, 300, 350, 400
	JD6 <sup>①</sup>	65	35	25	J6	STD	STD	STD	200, 225, 250, 300, 350, 400
	HJXD6 <sup>①</sup>	100	65	35	H6	ADD	ADD	ADD	200, 225, 250, 300, 350, 400
	HJD6 <sup>①</sup>	100	65	35	H5	ADD	ADD	ADD	200, 225, 250, 300, 350, 400
	SJD6 <sup>①</sup>	65	35	25	SJ	ADD	ADD	ADD	200, 300, 400
	SHJD6 <sup>①</sup>	100	65	35	S2	ADD	ADD	ADD	200, 300, 400
	CJD6 <sup>①</sup>	200	200	100	CJ	ADD	ADD	ADD	200, 300, 400
	SCJD6 <sup>①</sup>	200	200	100	SC	ADD	ADD	ADD	200, 300, 400
600	LXD6 <sup>①</sup>	65	35	25	LX	STD	STD	STD	450, 500, 600
	LD6 <sup>①</sup>	65	35	25	L6	STD	STD	STD	250, 300, 350, 400, 450, 500, 600
	HLXD6 <sup>①</sup>	100	65	35	HL	ADD	ADD	ADD	250, 300, 350, 400, 450, 500, 600
	HLD6 <sup>①</sup>	100	65	35	HO	ADD	ADD	ADD	250, 300, 350, 400, 450, 500, 600
	SLD6 <sup>①</sup>	65	35	25	SL	ADD	ADD	ADD	300, 400, 500, 600
	SHLD6 <sup>①</sup>	100	65	35	S6	ADD	ADD	ADD	300, 400, 500, 600
	CLD6 <sup>①</sup>	200	150	100	CL	ADD	ADD	ADD	300, 400, 500, 600
	SCLD6	200	150	100	C6	ADD	ADD	ADD	300, 400, 500, 600

① Vertically mounted

② STD = Standard configuration. ADD = Additional cost.

11

PANELBOARDS

# Panelboards

## Type P3 Panelboards

Selection

### Branch Circuit Breakers

Max. Amp Rating	Bolt-On Breaker Type	Amps	Provisions for Maximum Interrupting Rating (kA)						
			120V AC	120/240V AC	240V AC	277V AC	480V AC	600V AC	250V DC
100	BL	15-60	10	—	—	—	—	—	—
		70	—	10	—	—	—	—	—
		80-100	—	—	10	—	—	—	—
	BLH	15-60	—	22	—	—	—	—	—
		70	—	22	—	—	—	—	—
		80-100	—	—	22	—	—	—	—
	HBL	15-55	—	65	—	—	—	—	—
	60-100	—	—	65	—	—	—	—	—
	BL, (HID)	15-30	10	—	—	—	—	—	—
	BLR (240V)	15-60	—	—	10	—	—	—	—
		70-100	—	—	10	—	—	—	—
	BLE (GFCI)	15-30	10	—	—	—	—	—	—
		40-60	—	10	—	—	—	—	—
	BLEH (GFCI)	15-30	22	—	—	—	—	—	—
		15-60	—	22	—	—	—	—	—
BLF (GFCI)	15-30	10	—	—	—	—	—	—	
	40-60	—	10	—	—	—	—	—	
BLHF (GFCI)	15-30	22	—	—	—	—	—	—	
	40-60	—	22	—	—	—	—	—	
HBLF2 (GFCI)	15-30	65	—	—	—	—	—	—	
BGL <sup>①</sup>	15-30	10	—	—	—	—	—	—	
BAF	15-20	10	—	—	—	—	—	—	
BAFH	15-20	22	—	—	—	—	—	—	
BQD	15-60	—	65	—	—	14	—	14	
	70-100	—	—	65	—	14	—	14	
125	NGB	15-125	100	100	100	25	—	—	14 <sup>④</sup>
		15-125	100	100	100	35	—	—	14 <sup>④</sup>
		15-125	100	100	100	65	—	—	14 <sup>④</sup>
	ED4	15-60	65	—	—	22	—	—	—
		70-100	—	—	65	—	18	—	30
		110-125	—	—	65	—	18	—	—
	ED6 <sup>⑤</sup>	20-50	—	—	65	—	25	18	30
		70-100	—	—	65	—	25	18	—
		110-125	100	—	—	—	—	—	—
	HED4	15-60	100	—	—	—	—	—	—
70-125		—	—	—	65	—	—	—	
HHED6	15-50	—	—	100	—	65	18	—	
NGB2	15-125	100	100	100	25	25	14	14 <sup>④</sup>	
HGB2	15-125	100	100	100	35	35	22	22 <sup>④</sup>	
LGB2	15-125	100	100	100	65	65	25	25 <sup>④</sup>	
225	QR2	100-225	—	—	10	—	—	—	—
	QRH2	100-225	—	—	25	—	—	—	—
	HQR2	100-225	—	—	65	—	—	—	—
	HQR2H	100-225	—	—	100	—	—	—	—
250 (3VA52)	MFAS	100-250	—	85	85	—	35	18	50
	HFAS	100-250	—	100	100	—	65	25	85
	CFAS	100-250	—	200	200	—	100	35	100

### Branch Device Limitations

Lighting and appliance branch circuit panelboards were included in editions of the National Electrical Code prior to 2008. By application rule (408.15 in all versions of the NEC prior to 2008), lighting and appliance panels are limited to 42 installed circuits. Each over current device pole counts as a circuit.

### Subfeed Breakers (available in 2-pole or 3-pole)

Breaker Type	Mounting Position When Used as Subfeed Breaker	Ampere Ratings For Load	Maximum Interrupting Rating (kA) Symmetrical		
			240V AC	480V AC	600V AC
FD6 <sup>②</sup> , FXD6	Twin (Vertical)	70-250	65	35	18
HFD6 <sup>②</sup> , HFXD6	Twin (Vertical)	70-250	100	65	25
JD6 <sup>③</sup> , JXD6	Single (Horizontal)	200-400	65	35	25
HJD6 <sup>③</sup> , HJXD6	Single (Horizontal)	200-400	100	65	35

### Neutral Connectors

Wire Range	Max. Number of Connections	Max. Amps
#14-#1/0	44	125
#4 - 350 kcmil	6	250
(1)#4 - 600 kcmil or (2)#6 - 250 kcmil	1	400

**NOTE:** QJ/QR Breakers are twin mounted in unit space and take 6" of unit space. Limited to (6) per panel max. BL, HBL, BLH and BQD breakers are mounted in common mountings in 3" or (6) pole increments. ED4, ED6, HED4 and HHED6 breakers are mounted in common mountings in 3" or (6) pole increments.

① BGL 2-pole is (1) phase and neutral 3-pole is (2) phases and neutral.  
 ② Twin mounted subfeed breakers are mounted at bottom of panelboard only and adds 24" to the panel height.

③ Subfeed breaker is mounted at bottom of panelboard only. 400 amp subfeed breaker adds 30" to the panel height.  
 ④ 2-pole only (or) two outer poles of 3-pole breaker.  
 ⑤ ED6/CE6 2-pole limited amps available (20-50A).

# Panelboards

## Type P3 Panelboards

Selection

### Typical Catalog Numbers

**Main Lugs Only** – Examples of Panel numbers w/o options that add to box height.  
– Shown with Aluminum bus, Top fed, and Surface Trims

Max. Panel Amp Rating	Max. Unit Space (inches)	120/240V 1-Phase, 3-Wire	208Y/120V 3-Phase, 4-Wire	240/120V Delta 3Ø4W BØ High Leg	Box Height Inches
		Catalog Number	Catalog Number	Catalog Number	
250	27	P3A56ML250ATS	P3C56ML250ATS	P3B56ML250ATS	56
	33	P3A62ML250ATS	P3C62ML250ATS	P3B62ML250ATS	62
	39	P3A68ML250ATS	P3C68ML250ATS	P3B68ML250ATS	68
	45	P3A74ML250ATS	P3C74ML250ATS	P3B74ML250ATS	74
	45	P3A80ML250ATS	P3C80ML250ATS	P3B80ML250ATS	80
400	21	P3A56ML400ATS	P3C56ML400ATS	P3B56ML400ATS	56
	27	P3A62ML400ATS	P3C62ML400ATS	P3B62ML400ATS	62
	33	P3A68ML400ATS	P3C68ML400ATS	P3B68ML400ATS	68
	39	P3A74ML400ATS	P3C74ML400ATS	P3B74ML400ATS	74
	45	P3A80ML400ATS	P3C80ML400ATS	P3B80ML400ATS	80
600	21	P3A56ML600ATS	P3C56ML600ATS	P3B56ML600ATS	56
	27	P3A62ML600ATS	P3C62ML600ATS	P3B62ML600ATS	62
	33	P3A68ML600ATS	P3C68ML600ATS	P3B68ML600ATS	68
	39	P3A74ML600ATS	P3C74ML600ATS	P3B74ML600ATS	74
	45	P3A80ML600ATS	P3C80ML600ATS	P3B80ML600ATS	80
800	21	P3A56ML800ATS	P3C56ML800ATS	P3B56ML800ATS	56
	27	P3A62ML800ATS	P3C62ML800ATS	P3B62ML800ATS	62
	33	P3A68ML800ATS	P3C68ML800ATS	P3B68ML800ATS	68
	39	P3A74ML800ATS	P3C74ML800ATS	P3B74ML800ATS	74
	45	P3A80ML800ATS	P3C80ML800ATS	P3B80ML800ATS	80

Max. Panel Amp Rating	Max. Unit Space (inches)	480V Delta 3-Phase, 3-Wire	240V Delta 3-Phase, 3-Wire	480Y/277V 3-Phase, 4-Wire	Box Height Inches
		Catalog Number	Catalog Number	Catalog Number	
250	27	P3F56ML250ATS	P3D56ML250ATS	P3E56ML250ATS	56
	33	P3F62ML250ATS	P3D62ML250ATS	P3E62ML250ATS	62
	39	P3F68ML250ATS	P3D68ML250ATS	P3E68ML250ATS	68
	45	P3F74ML250ATS	P3D74ML250ATS	P3E74ML250ATS	74
	45	P3F80ML250ATS	P3D80ML250ATS	P3E80ML250ATS	80
400	21	P3F56ML400ATS	P3D56ML400ATS	P3E56ML400ATS	56
	27	P3F62ML400ATS	P3D62ML400ATS	P3E62ML400ATS	62
	33	P3F68ML400ATS	P3D68ML400ATS	P3E68ML400ATS	68
	39	P3F74ML400ATS	P3D74ML400ATS	P3E74ML400ATS	74
	45	P3F80ML400ATS	P3D80ML400ATS	P3E80ML400ATS	80
600	21	P3F56ML600ATS	P3D56ML600ATS	P3E56ML600ATS	56
	27	P3F62ML600ATS	P3D62ML600ATS	P3E62ML600ATS	62
	33	P3F68ML600ATS	P3D68ML600ATS	P3E68ML600ATS	68
	39	P3F74ML600ATS	P3D74ML600ATS	P3E74ML600ATS	74
	45	P3F80ML600ATS	P3D80ML600ATS	P3E80ML600ATS	80
800	21	P3F56ML800ATS	P3D56ML800ATS	P3E56ML800ATS	56
	27	P3F62ML800ATS	P3D62ML800ATS	P3E62ML800ATS	62
	33	P3F68ML800ATS	P3D68ML800ATS	P3E68ML800ATS	68
	39	P3F74ML800ATS	P3D74ML800ATS	P3E74ML800ATS	74
	45	P3F80ML800ATS	P3D80ML800ATS	P3E80ML800ATS	80

General Note: Panel numbers and box sizes are for reference only - COMPAS will configure proper Box size needed.

# Panelboards

Type P3 Panelboards

Selection

 11  
 PANELBOARDS

## Typical Catalog Numbers

**Main Circuit Breaker** – Examples of Panel numbers w/o options that add to box height.  
 – Shown with Aluminum bus, Top fed, and Surface Trims

Max. Panel Amp Rating	Max. Unit Space (inches)	120/240V 1-Phase, 3-Wire	208Y/120V 3-Phase, 4-Wire	240/120V Delta 3Ø4W BØ High Leg	Box Height Inches
		Catalog Number	Catalog Number	Catalog Number	
250 <sup>①</sup>	21	P3A56FD250ATS	P3B56FD250ATS	P3C56FD250ATS	56
	27	P3A62FD250ATS	P3B62FD250ATS	P3C62FD250ATS	62
	33	P3A68FD250ATS	P3B68FD250ATS	P3C68FD250ATS	68
	39	P3A74FD250ATS	P3B74FD250ATS	P3C74FD250ATS	74
	45	P3A80FD250ATS	P3B80FD250ATS	P3C80FD250ATS	80
400 <sup>②</sup>	9	P3A56JD400ATS	P3B56JD400ATS	P3C56JD400ATS	56
	15	P3A62JD400ATS	P3B62JD400ATS	P3C62JD400ATS	62
	21	P3A68JD400ATS	P3B68JD400ATS	P3C68JD400ATS	68
	27	P3A74JD400ATS	P3B74JD400ATS	P3C74JD400ATS	74
	33	P3A80JD400ATS	P3B80JD400ATS	P3C80JD400ATS	80
600 <sup>③</sup>	9	P3A56LD600ATS	P3B56LD600ATS	P3C56LD600ATS	56
	15	P3A62LD600ATS	P3B62LD600ATS	P3C62LD600ATS	62
	21	P3A68LD600ATS	P3B68LD600ATS	P3C68LD600ATS	68
	27	P3A74LD600ATS	P3B74LD600ATS	P3C74LD600ATS	74
	33	P3A80LD600ATS	P3B80LD600ATS	P3C80LD600ATS	80

Max. Panel Amp Rating	Max. Unit Space (inches)	480V Delta 3-Phase, 3-Wire	240V Delta 3-Phase, 3-Wire	480Y/277V 3-Phase, 4-Wire	Box Height Inches
		Catalog Number	Catalog Number	Catalog Number	
250 <sup>①</sup>	21	P3F56FD250ATS	P3D56FD250ATS	P3E56FD250ATS	56
	27	P3F62FD250ATS	P3D62FD250ATS	P3E62FD250ATS	62
	33	P3F68FD250ATS	P3D68FD250ATS	P3E68FD250ATS	68
	39	P3F74FD250ATS	P3D74FD250ATS	P3E74FD250ATS	74
	45	P3F80FD250ATS	P3D80FD250ATS	P3E80FD250ATS	80
400 <sup>②</sup>	9	P3F56JD400ATS	P3D56JD400ATS	P3E56JD400ATS	56
	15	P3F62JD400ATS	P3D62JD400ATS	P3E62JD400ATS	62
	21	P3F68JD400ATS	P3D68JD400ATS	P3E68JD400ATS	68
	27	P3F74JD400ATS	P3D74JD400ATS	P3E74JD400ATS	74
	33	P3F80JD400ATS	P3D80JD400ATS	P3E80JD400ATS	80
600 <sup>③</sup>	9	P3F56LD600ATS	P3D56LD600ATS	P3E56LD600ATS	56
	15	P3F62LD600ATS	P3D62LD600ATS	P3E62LD600ATS	62
	21	P3F68LD600ATS	P3D68LD600ATS	P3E68LD600ATS	68
	27	P3F74LD600ATS	P3D74LD600ATS	P3E74LD600ATS	74
	33	P3F80LD600ATS	P3D80LD600ATS	P3E80LD600ATS	80

General Note: Panel numbers and box sizes are for reference only - COMPAS will configure proper Box size needed.

① 250A: for Vert. FD subtract 6" of unit space; for CFD subtract 12" of unit space

② 400A: for CJD box height 56 does not exist, subtract 6" from unit space for all others

③ 600A: for CLD box height 56 does not exist, subtract 6" from unit space for all others

# Panelboards

## Type P3 Panelboard Modifications and Additions

Selection

### Enclosures

#### Extra Gutter to Sides or Ends of the Can (Type 1 Only)

Description
6" end gutter 2" side gutter Barrier in gutter (add to extra gutter price – min 4" required)
Hinged trims Piano hinged trims Door-in-door trims Screw to the box trims
Trim mounted devices . . . . . See page 11-87 <ul style="list-style-type: none"> <li>• Pilot lights</li> <li>• Toggle switches</li> <li>• Push buttons</li> </ul>
Painted boxes . . . . . See page 11-87 Custom colors . . . . . See painted boxes
Increase gauge trims and boxes . . . . . See page 11-87
Stainless steel trims, Type 1 . . . . . See page 11-87

#### Meters

(Contact sales for pricing and application engineering for space requirements)

#### Panel Skirts

See page 11-88

#### Special Locks (see page 11-7)

TEY
TEU1
Cat 60
LL803
LL806
Yale 47 (NYC)
National C413A
Best Lock 7-pin tumbler
Southco 1/4" Fastener
Corbin 1001 FAB7

### Panel Bus Modifications

Main Bus	Catalog Number Addition Amperes Ratings			
	125A	250A	400A	600A
750 A/SI AL.	B	B	B	B
Copper (tin pltd.)	F	F	F	F
Copper (silver pltd.)	E	E	E	E
1000 A/SI Copper (tin pltd.)	G	G	G	G
1000 A/SI Copper (silver pltd.)	H	H	H	H

### Subfeed, Feed-Thru and Split Bus (for 2-pole or 3-pole)

Ampere Rating	Connector Cu/Al Wire Range	Unit Space (inches)
---------------	----------------------------	---------------------

#### Subfeed (Double) Lugs for Main Lug Panelboards Only (400 max)

225/250	(2)—#6 AWG-350 kcmil	6
400	(4)—250 kcmil (2)—600 kcmil	6

#### Feed-Thru Lugs — Cannot Be Used in Conjunction with TVSS or Subfeed Breakers

See page 11-46 for unit space adders and compatibility with other options.

225/250	(1)—#6 AWG-350 kcmil	6
400	(2)—250 kcmil (1)—600 kcmil	6
600	(2)—250-500 kcmil	9
800	(2)—600 kcmil	12

#### Split Bus (1 per interior)

225/250	(1)—#6 AWG-350 kcmil	6
400	(2)—250 kcmil (1)—600 kcmil	6
600	(2)—250-500 kcmil	6
800	(2)—600 kcmil	6

#### Branch and Main Breaker Accessories

See page 11-85 and Breaker Section <ul style="list-style-type: none"> <li>• Handle blocks</li> <li>• Handle locks</li> <li>• Aux. Contacts<sup>Ⓞ</sup></li> <li>• UVR<sup>Ⓞ</sup></li> </ul>
----------------------------------------------------------------------------------------------------------------------------------------------------------------------------------------------

#### Increase capacity neutral up to 200%

Main Bus Amps
125
250
400
600

See page 11-46 for unit space adders and compatibility with other options.

#### Copper MLO Only

Main Bus Amps
125
250
400
600

(Devices mounted and wired to the trim should also have hinge-to-box trim specified)

### Bus mounted SPD

See Section 10 for TPS1

#### Service Entrance Label

Type P3 Panelboards are factory labeled suitable for use as service entrance equipment when NEC requirements are met. A panelboard cannot have more than six main disconnects, unless it is a lighting and appliance branch panelboard. Lighting and appliance branch panelboards are limited to two main disconnects. Factory installed and field installable Service Entrance Barrier kits are now available as required by UL67 (In COMPAS, you must select Service Entrance Required).

#### Grounding of Panelboards

Ground Bars except for brazed to box are shipped with the panel interior not factory mounted.

- Non-Insulated Equipment Ground Bar
- Copper Non-Insulated Ground Bar
- Al Insulated Equipment Ground Bar
- Cu Insulated Equipment Ground Bar
- Ground Bar Brazed to Box (Not recommended for painted or NEMA 3R enclosures)

#### Shunt Trip on Main or Branch

BL, BLH, HBL, BQD, ED4, HED4, ED6, HHED6, QR2, QRH2, HQR2, HQR2H as branch only. BL, BLH, HBL, NGB, HGB, LGB, ED4, HED4, ED6, HHED6 uses 1" unit space for shunt trip. All others may be used on mains or subfeeds.

#### Time Clocks

Time clocks may be mounted in a 23" enclosure to be cable connected to the panel. Sangamo, Tork or Paragon time clock can be supplied and mounted in panelboard cabinet. Adds 12" to panel height. Mounts in Sub-area.

Description
Time Clock (1 or 2-pole, single or double throw contacts; 3-pole, single throw) 277V maximum with plain dial
Astronomical dial
An omitting device
Reserve power or carryover
Space and mounting provisions only

<sup>Ⓞ</sup> Accessories on 1" pole breakers (BL, BQD, ED) will take unit space.

# Panelboards

## Type P3 Panelboard Standard Modifications

Selection

### Option Combinations

Amps	Incoming	Subfeed Lugs	Feed-thru Lugs	FD <sup>①</sup> Subfeed	JD <sup>①</sup> Subfeed	FD <sup>②</sup> Subfeeds	200% Neutral	Min. Box Size (in.)	Unit Space (in.)		
250	Main Lug Only	—	• — —	— • —	— — —	— — •	• • •	56 56 56	27 15 9		
		Main Lugs w/Subfeed Lugs	•	• — —	— • —	— — —	— — •	• • •	56 56 62	21 21 9	
			Main Breaker (Horiz. FD)	—	• —	— •	— —	— —	• •	56 56	21 9
	Main Breaker (Vert. FD)	None Std.		• —	— •	— —	— —	• •	56 68	15 9	
	Main Breaker (CFD)	None Std.	• —	— •	— —	— —	• •	56 68	9 9		
400 <sup>②③</sup>	Main Lug Only	•	— • — — —	— • — — —	— — • — —	— — — • —	• • • • •	56 56 56 56 62	21 15 9 9 9		
		Main Breaker (JD)	None Std.	— • — — —	— — • — —	— — — • —	— — — — •	• • • • •	56 62 68 68 74	9 9 9 9 9	
			Main Breaker (CJD)	None Std.	— • — — —	— — • — —	— — — • —	— — — — •	• • • • •	62 74 74 74 80	9 9 9 9 9
				Main Lug Only	—	• — — — —	— • — — —	— — • — —	— — — • —	• • • • •	56 56 56 56 62
	Main Breaker LD				—	• — — — —	— • — — —	— — • — —	— — — — •	• • • • •	56 62 68 68 74
Main Breaker CLD		—			• — — — —	— • — — —	— — • — —	— — — — •	• • • • •	62 68 74 74 80	9 9 9 9 9
		Main Lug Only	—		• — — — —	— • — — —	— — • — —	— — — — •	• • • • •	56 56 56 56 62	21 9 9 9 9

① Subfed lugs are currently not offered as standard with main circuit breakers.

② Subfed lugs on panels above 400A are not standard.

③ 200% neutral cannot be provided along with a 400A subfeed breaker because the breaker blocks the 4th lug site.

# Panelboards

## Type P3 Panelboard Modifications and Additions

Selection

### Compression Lugs

Style	Amp Rating	Breaker Type	Compression Connectors	Box Height Addition
MLO	250	N/A	(1)#6 AWG - 350 kcmil	—
	400	N/A	(1) 250 - 500 kcmil or (2)# 1/0 AWG - 250 kcmil	—
	600	N/A	(2)#3/0 AWG - 500 kcmil	—
	800	N/A	(2) 400-750 kcmil Cu only	—
Main Breaker	250	FXD6, HFD6, CFD6	(1)#6 AWG - 350 kcmil Cu or Al	CFD6 requires an additional 6.0" box height
	400	JD6, JXD6, HJD6, CJD6, SJD6, SHJD6, SCJD6	(2)#1/0 AWG - 500 kcmil Cu or Al	—
	600	LD6, LXD6, HLD6, CJD6, SLD6, SHLD6, SCLD6	(2)#2/0 AWG - 500 kcmil Cu or Al	—

### Alternate Lugs

Style	Amp Rating	Breaker Type	Standard AL Connectors	Box Height Addition
MLO	400	N/A	(1) 250 - 750 kcmil or (2)#3/0 AWG - 250 kcmil Cu or Al	6
	800	N/A	(3) 500 kcmil	6
Main Breaker	400	JD6, JXD6, HJD6, CJD6, SJD6, SHJD6, SCJD6	(1)#4/0 AWG - 750 kcmil Cu or Al	6

### Enclosure Modifications

24" Panel Width Description
NEMA 3R enclosures
NEMA 3R/12 enclosures <sup>①</sup>
Gasket between trim and box (Type 1)

### NEMA-4X For Type P3<sup>③</sup> Water Tight, Dust Tight and Corrosion Resistant (consult plant for actual enclosure size and for NEMA 4<sup>②</sup> enclosures)

Box Height Inches	Enclosure – Stainless Steel		
	H	W	D
56	56	24	7.75
62	62	24	7.75
68	68	24	7.75
74	74	24	7.75
80	80	24	7.75

① 16 Gauge Cans w/ 14 Gauge Front)  
 ② 14 Gauge only  
 ③ 14 Gauge only - 304SS Std, 316SS Optional)

# Panelboards

## Type P3 Panelboard Kits and Accessories

Selection

### Standard Enclosures

Box Height (in.)	Catalog Number				
	Type 1 Standard Trim			Type 3R	Type 3R/12
	Box	Surface	Flush		
56	24WD56	P3S56	P3F56	24NRD56	24WPD56
62	24WD62	P3S62	P3F62	24NRD62	24WPD62
68	24WD68	P3S68	P3F68	24NRD68	24WPD68
74	24WD74	P3S74	P3F74	24NRD74	24WPD74
80	24WD80	P3S80	P3F80	24NRD80	24WPD80

### Options For Type 1 Trims

Items must be ordered as manual line item on factory

Hinged trim – Add “H” suffix

Door-in-door – Add “D” suffix

Metal card holder – Add “M” suffix

### Breaker Kits and Accessories

Kit Number	Description	Contents
BBKB32 (P2/P3)	BL/BQD 6-pole 3" branch breaker kit	Kit contains top barrier, (3) A/C connectors, (1) B connector, hardware
BBKNB32 (P2/P3)	NGB, HGB, LGB 6-pole 3" branch breaker kit	Kit contains top barrier, (3) A/C connectors, (1) B connector, hardware
BBKGB32 (P2/P3)	NGB2, HGB2, LGB2 6-pole 3" branch breaker kit	Kit contains top barrier, (3) A/C connectors, (1) B connector, hardware
BBKEB32 (P3)	NEB/HEB 6-pole 3" branch breaker kit	Kit contains top barrier, (3) A/C connectors, (1) B connector, hardware
BBKED32 (P2/P3)	ED 6-pole 3" branch breaker kit	Kit contains breaker support, inter-phase barriers, (3) A/C connectors, (1) B connector, hardware
BBKQ2 (P3)	Branch breaker kit for 2 and 3-pole QJ twin mount	Kit contains all connectors and cover plates necessary to mount both 2 and 3-pole breakers
BBKQR2 <sup>①③</sup>	P3 twin BKR mounting kit for QR 1-phase/3-phase	Kit contains all connectors and cover plates necessary to mount both 2 and 3-pole breakers (limit 6 QR per panel)
BBKVA52P3T <sup>②</sup>	P3 strap kit; twin mount 3VA52 branch	Uses 6" of unit space. Includes 2x BBKVA52P3HW, barrier, straps, & mounting hardware.
BBKVR52P3HW	P3 branch breaker hardware kit	Includes screw retainers & mounting screws.
DFK1	BL, BQD, ED deadfront kit for 1" pole breakers	Center strips 3", 6", 9", 15", 21" plus mounting hardware
DFFP3	Deadfront filler 3"	3" empty space filler and hardware
DFFP6	Deadfront filler 6"	6" empty space filler and hardware
P3BK1	P3 bonding kit	Bonding strap and hardware
EBF1	HEB/NEB Filler Plate	Filler Plate
BBKQRP2FK	P3 Filler for QR. Dual mount horizontal. 1-phase/3-phase.	Kit contains all cover plates necessary to change from QJ to QR both 2 and 3-pole breakers. For 1-phase panel, both breakers must change from QJ to QR, cannot have one of each installed.
SEBKP3V1 <sup>②</sup>	Service entrance barrier kit CFD, FD (P3 only)	Kit contains barrier, mounting brackets, and hardware
SEBKP1P2P3V1 <sup>②</sup>	JD, LD Service Entrance Barrier Kit (RP1, P1, P2, P3)	Kit contains barrier, mounting brackets, and hardware
SEBKP3V3	FD, QJ, QR Horizontal Main Service Entrance Barrier (P2, P2 with SEM3, P3)	Kit contains barrier, mounting brackets, and hardware

① Although QR is rated 250A, it is limited to 225A in panelboard.

② Factory installed and Field installable Service Entrance Barrier kits are now available as required by UL67. (In COMPAS, you must select Service Entrance Required.)

③ Maximum 6 large frame breakers in unit space. (QR + 3VA52)

## Type P1, P2, and P3 Panelboards

### Miscellaneous Parts and Accessories

Catalog Number	Description
EGK	Al Ground Bus 44 Connections
BK1	Bonding kit for 250A max. and all P1 panels
IMK1	Interior Adjusting Kit
LPDC01	Directory Card (Pack of 10; ref. 12-1110-01)
LPDC02	Directory Card Holder (Pack of 10; ref. 11-1824-01)
NBK3	Number Strips 1-42. Snap-in type; Use w/P2 & P3 series Panels
NBK4	Number Strips 43-84. Snap-in type; Use w/P2 & P3 series Panels
NBK5	Number Strips 85-126. Snap-in type; Use w/P2 & P3 series Panels
NBK6	Number Strips 127-168. Snap-in type; Use w/P2 & P3 series Panels
NBK7	Number Strips 169-210. Snap-in type; Use w/P2 & P3 series Panels
NBK8	Number Strips 211-252. Snap-in type; Use w/P2 & P3 series Panels
ECGK	Cu Ground Bus 44 Connections
IGK	Insulated Al Ground Bus
ICGK	Insulated Cu Ground Bus
EWK2	End Wall Kit with Knockouts (24" W x 7.75" DP)
DFFP1	1" Filler Plate (used for BL/BQD/xGB/xGB2/ED blank positions) (Suitable for replacing QF3 in P1 thru P5 Panelboards and Switchboards)
ANSI/NEMA PB 1.1-2013	General Instructions for Proper Installation, Operation, and Maintenance of Panelboards Rated 600 Volts or Less (O&M Manual) <sup>①</sup>

① PDF can be downloaded (at no cost) and printed at this location: <http://www.nema.org/standards/pages/Panelboards.aspx>



# Panelboards

## Type P3 Panelboards

## Dimensions

### Type 1 Box

Box is symmetrical

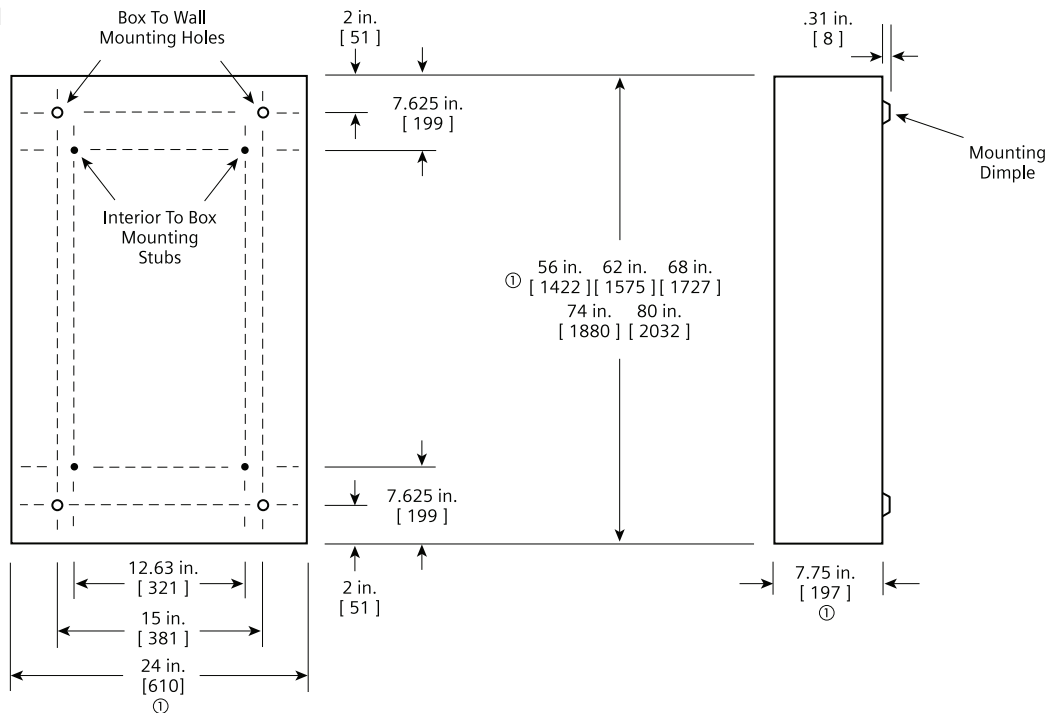

(UL approved construction. 16 gage steel or equivalent alternate construction. 14 or 12 gage is available as an optional special order.)  
A60 Galvannealed is standard without paint.

### Type 3R and 3R/12 Box

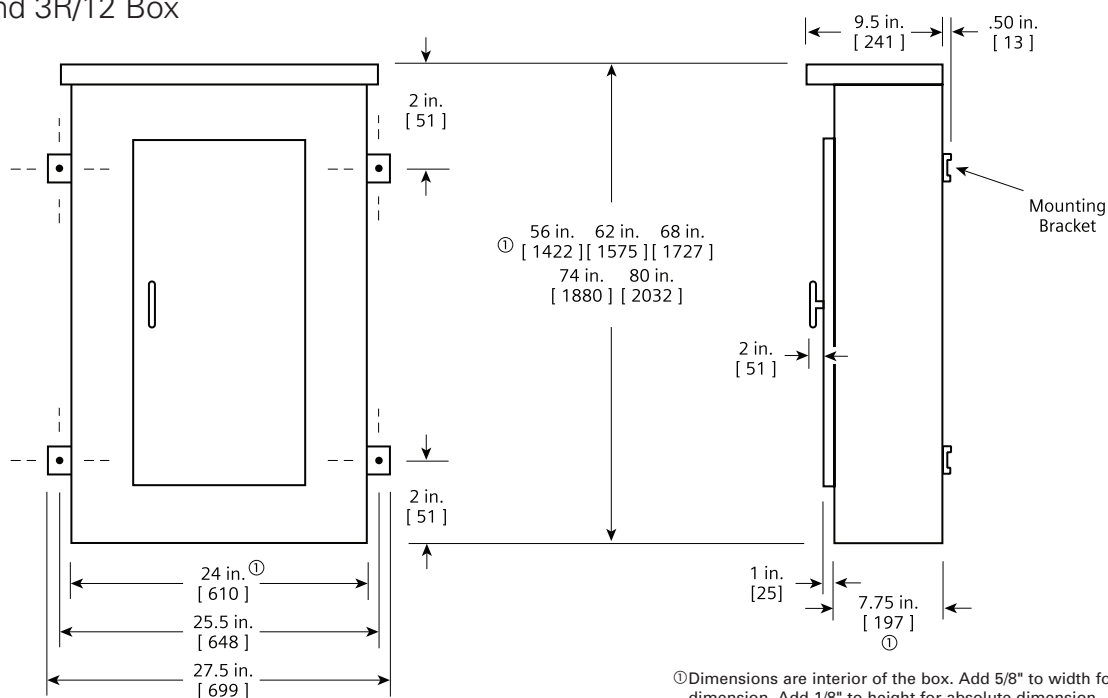

①Dimensions are interior of the box. Add 5/8" to width for absolute dimension. Add 1/8" to height for absolute dimension.  
Dimensions shown in inches and millimeters [ ].

(UL approved construction. 16 gage steel can with 14 gage front or similar approved construction.)  
A60 Galvannealed with ANSI 61 light gray paint is standard.

# P3 Lighting Panelboard

New 3VA52 250A TMTU breakers

General

PANELBOARDS 11

## P3 Lighting Panelboard Key Features:

- 600A max MB or 800A max MLO
- Up to 45" unit space available
- **NEW** Up to 6 large frame breakers in unit space – total of 225A QR & 250A 3VA52 Breakers (only 6" of unit space for each twin mount kit)
- Branch area can also have various 100-125A Frame breakers: BL/BQD/GB/GB2/ED
- Subfeed Space can include one 400A JD frame or two 250A FD frame breakers in the same panel.
- **Small footprint: 24" wide x 7.75" Deep (56-80"H)**

## P3 Lighting Panelboard

### P3 Main Space can include:

Main Lugs: 250A, 400A, 600A or 800A  
 ==> also Subfeed Lugs: 250A or 400A

### Main Breaker Types:

- 250A max. FD series (horizontal mount)
- 400A max. JD series (vertical mount)
- 600A max. LD series (vertical mount)

### Future 3VA offering in development:

- 250A max. 3VA52 (TMTU) (horiz. mount)
- 400A max. 3VA63 (ETU) (vert. mount)
- 600A max. 3VA64 ETU (vert. mount) (ETU = Electronic Trip Unit)

### P3 Branch Breakers — Large Frame (6 max.):

- 225A max QR series
- 250A max 3VA52 Series (NEW FY18) (total 225A/250A frame, six per panel limit)

### Future 3VA offering in development:

- 250A max 3VA62/3VA61 ETU single mount

**New 3VA52 offering has many field installable accessories available including strap kits.**

### P3 Branch Breakers — Small Frame:

- 100A max BL series
- 100A max BQD series
- 125A max ED series (480V delta capable)
- 125A max xGB series (480V delta capable)
- 125A max GB2 series (480V delta capable)

### Future 3VA offering in development:

- 125A max. 3VA TMTU (480V delta capable)

### P3 Subfeed Space offering:

#### Feed-thru Lugs:

- A) 225A/250A, 400A, 600A or 800A
- B) Surge Protection Devices (SPD)

#### C) Subfeed Breakers:

- 250A max. FD twin mount vertical
- 400A max. JD single mount vertical

### Future 3VA offering in development:

- 250A max. 3VA52 TMTU (vertical twin mount)
- 400A max. 3VA63 ETU (vertical mount)

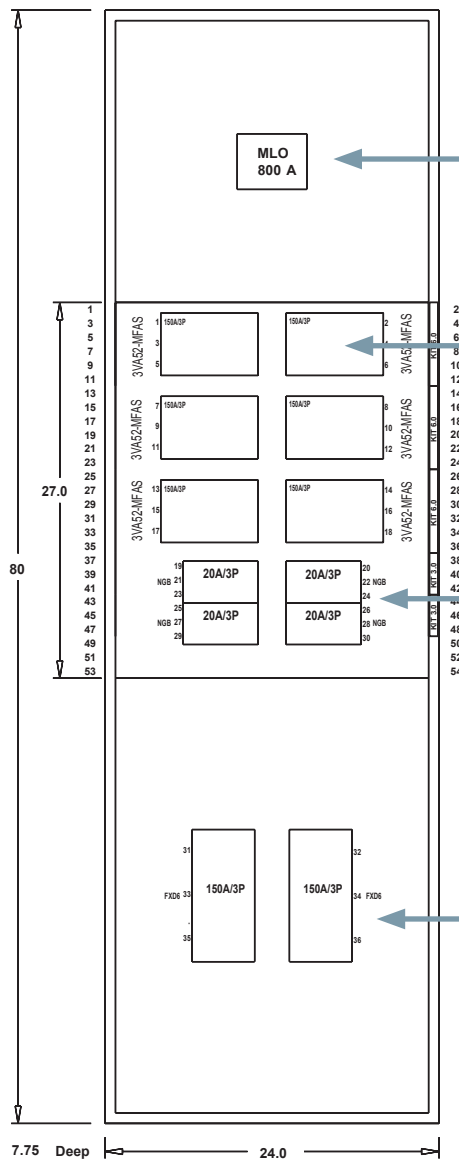
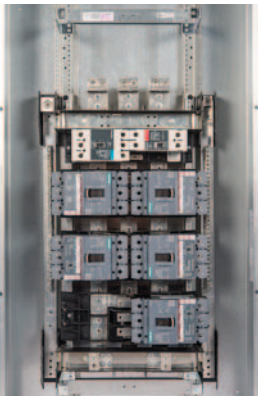

# P3 Lighting Panelboard

New 3VA52 250A TMTU breakers

Selection

## 3VA52 250A TMTU – Feature Rich Configurations Available

### 3VA52 Breaker Features:

- 480V Delta Rated up to 100kA (600V Delta to 35kA) (see page 11-50 for details)
- TM230 Thermal-Magnetic Trip included (TMTU)
- Field replaceable internal accessories that are shared with entire line of 3VA products.
- Easily configured in COMPAS with all variations available in a P3 Lighting Panelboard

### 3VA Series Accessories

There are 4 positions on each side of the trip handle of the 3VA52 breaker.

Accessories can be 1, 2 or 3 positions wide and fit in specific locations as shown on charts and on the inside cover of each breaker.

#### Accessory types:

3VA breaker auxiliary releases allow remote electrical tripping of the circuit breaker

- **STL** – Shunt Trip Left
- **STF** – Shunt Trip Flexible
- **UVR** – Undervoltage Releases Trip
- **UNI** – Universal Release - Shunt Trip and an Undervoltage Release are Combined

All Auxiliary and Alarm Switches for 3VA breakers belong to an integrated range of accessories

- **AUX\_HQ / AUX\_HP** – Auxiliary Switches
- **LCS\_HQ / LCS\_HP** – Leading Changeover Switches
- **TAS\_HQ / TAS\_HP** – Trip Alarm Switches
- **EAS\_HQ / EAS\_HP** – Electrical alarm switches

3VA Auxiliary and Alarm Switches have standard (HQ) and high capacity (HP) types as well as “electronic” versions for example: **AUX\_HQ\_eI**

\* Padlock accessory will be available in a future release.

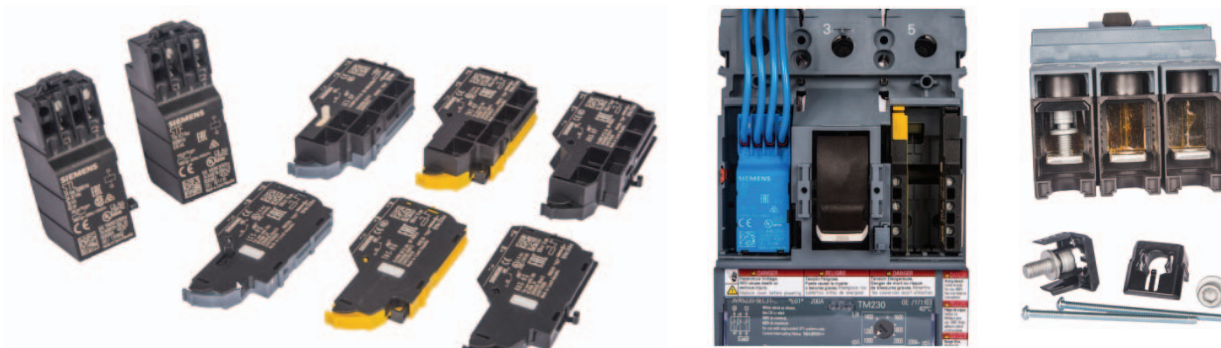
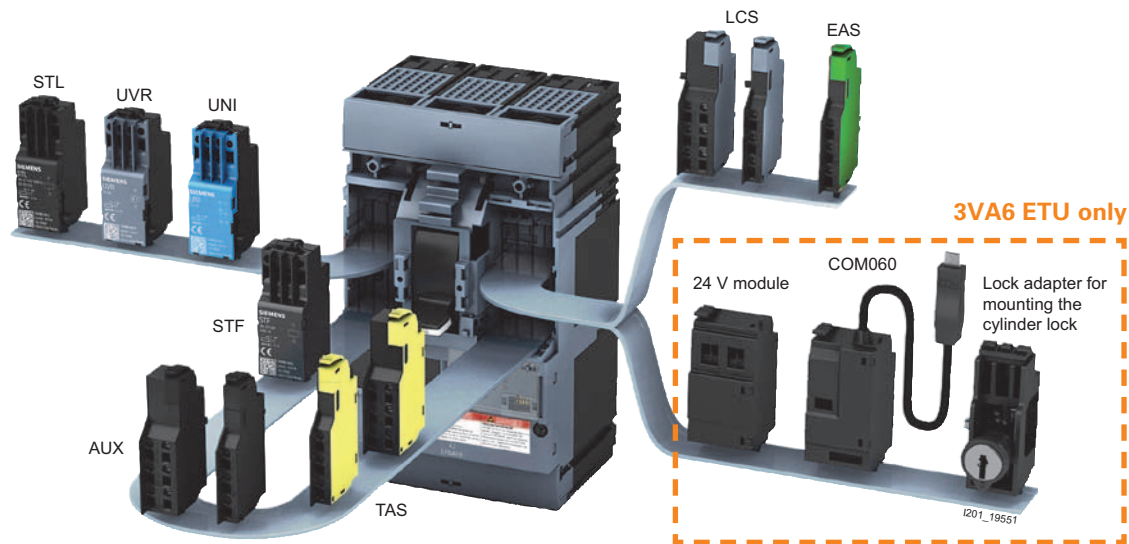

3VA accessories install easily. Special Hardware kit for P3 Twin Mount aligns screw for easy installation.

# P3 Lighting Panelboard

New 3VA52 250A TMTU breakers

Selection

## 3VA52 breakers for use in a P3 panelboard

### 3VA52 series breakers are Thermal Magnetic Trip (TMTU) type:

- The TM230 adjustable trip is standard for Factory installed configurations. (See 3VA literature for other trip options)

Amp ratings available:	100	110	125	150	175	200	225	250
Amp code for catalog number:	10	11	12	15	17	20	22	25

- Aluminum lugs are standard for factory assembled, CU lug can be specified. Field installable CU lug kits are available: Order kit # 3VA9233-0JD12

### 3 Pole 3VA52 without connectors

for AL order one 3VA9233-0JB12 connector kit

for CU order one 3VA9233-0JD12 connector kit

UL Type Code ==>	MFAS	HFAS	CFAS
	3-pole   2-pole	3-pole   2-pole	3-pole   2-pole
240 VAC kAIC rating ==>	85   85	100   100	200   200
480Y / 277VAC kAIC rating ==>	35   35	65   65	100   100
480 VAC kAIC rating ==>	35   35	65   65	100   100
600Y / 347VAC kAIC rating ==>	18   18	25   25	35   35
600 VAC kAIC rating ==>	18   18	25   25	35   35
250 VDC kAIC rating ==>	na   50	na   85	na   100

amps	code	Description FTAM Trip included ==>	Catalog Number TM230	Catalog Number TM230	Catalog Number TM230
100	10	3VA52 3P breaker w/TM230	3VA5210-5EC31-0AA0	3VA5210-6EC31-0AA0	3VA5210-7EC31-0AA0
110	11	3VA52 3P breaker w/TM230	3VA5211-5EC31-0AA0	3VA5211-6EC31-0AA0	3VA5211-7EC31-0AA0
125	12	3VA52 3P breaker w/TM230	3VA5212-5EC31-0AA0	3VA5212-6EC31-0AA0	3VA5212-7EC31-0AA0
150	15	3VA52 3P breaker w/TM230	3VA5215-5EC31-0AA0	3VA5215-6EC31-0AA0	3VA5215-7EC31-0AA0
175	17	3VA52 3P breaker w/TM230	3VA5217-5EC31-0AA0	3VA5217-6EC31-0AA0	3VA5217-7EC31-0AA0
200	20	3VA52 3P breaker w/TM230	3VA5220-5EC31-0AA0	3VA5220-6EC31-0AA0	3VA5220-7EC31-0AA0
225	22	3VA52 3P breaker w/TM230	3VA5222-5EC31-0AA0	3VA5222-6EC31-0AA0	3VA5222-7EC31-0AA0
250	25	3VA52 3P breaker w/TM230	3VA5225-5EC31-0AA0	3VA5225-6EC31-0AA0	3VA5225-7EC31-0AA0

### 2 Pole 3VA52 (in 3-Pole frame) without connectors

for AL order one 3VA9233-0JB12 connector kit

for CU order one 3VA9233-0JD12 connector kit

amps	code	Description FTAM Trip included ==>	Catalog Number TM230	Catalog Number TM230	Catalog Number TM230
100	10	3VA52 2P breaker w/TM230	3VA5210-5EC61-0AA0	3VA5210-6EC61-0AA0	3VA5210-7EC61-0AA0
110	11	3VA52 2P breaker w/TM230	3VA5211-5EC61-0AA0	3VA5211-6EC61-0AA0	3VA5211-7EC61-0AA0
125	12	3VA52 2P breaker w/TM230	3VA5212-5EC61-0AA0	3VA5212-6EC61-0AA0	3VA5212-7EC61-0AA0
150	15	3VA52 2P breaker w/TM230	3VA5215-5EC61-0AA0	3VA5215-6EC61-0AA0	3VA5215-7EC61-0AA0
175	17	3VA52 2P breaker w/TM230	3VA5217-5EC61-0AA0	3VA5217-6EC61-0AA0	3VA5217-7EC61-0AA0
200	20	3VA52 2P breaker w/TM230	3VA5220-5EC61-0AA0	3VA5220-6EC61-0AA0	3VA5220-7EC61-0AA0
225	22	3VA52 2P breaker w/TM230	3VA5222-5EC61-0AA0	3VA5222-6EC61-0AA0	3VA5222-7EC61-0AA0
250	25	3VA52 2P breaker w/TM230	3VA5225-5EC61-0AA0	3VA5225-6EC61-0AA0	3VA5225-7EC61-0AA0

# P3 Lighting Panelboard

New 3VA52 250A TMTU breakers

Accessories

## Accessories for 3VA52 breakers in a P3 panelboard

Description	Quick reference code	Voltage AC max or range	Voltage DC max or range	Accessory Catalog Number	Qty of slots in breaker req'd	Max. Qty. per 3VA52	Position to install for 3VA52 only									
							24	23	22	21	11	12	13	14		
<b>Pocket Reference # ==&gt;</b>																
<b>Internal Accessories</b> Left side only Only one per breaker allowed	Shunt trip left – 10	STL-10	n/a	12	3VA9978-0BL10	3	1			x						
	Shunt trip left – 20	STL-20	380...600	n/a	3VA9978-0BL20	3	1			x						
	Shunt trip left – 30	STL-30	24	24...30	3VA9978-0BL30	3	1			x						
	Shunt trip left – 31	STL-31	48...60	n/a	3VA9978-0BL31	3	1			x						
	Shunt trip left – 32	STL-32	110...127	110...127	3VA9978-0BL32	3	1			x						
	Shunt trip left – 33	STL-33	208...277	220...250	3VA9978-0BL33	3	1			x						
	Shunt trip flexible – 20	STF-20	24	n/a	3VA9978-0BA20	3	1			x						
	Shunt trip flexible – 21	STF-21	48...60	n/a	3VA9978-0BA21	3	1			x						
	Shunt trip flexible – 22	STF-22	110...127	n/a	3VA9978-0BA22	3	1			x						
	Shunt trip flexible – 23	STF-23	208...277	n/a	3VA9978-0BA23	3	1			x						
	Shunt trip flexible – 24	STF-24	380...500	n/a	3VA9978-0BA24	3	1			x						
	Shunt trip flexible – 25	STF-25	600	n/a	3VA9978-0BA25	3	1			x						
	Undervoltage release – 10	UVR-10	n/a	12	3VA9978-0BB10	3	1			x						
	Undervoltage release – 11	UVR-11	n/a	24	3VA9978-0BB11	3	1			x						
	Undervoltage release – 12	UVR-12	n/a	48	3VA9978-0BB12	3	1			x						
	Undervoltage release – 14	UVR-14	n/a	125...127	3VA9978-0BB14	3	1			x						
	Undervoltage release – 16	UVR-16	n/a	250	3VA9978-0BB16	3	1			x						
	Undervoltage release – 20	UVR-20	24	n/a	3VA9978-0BB20	3	1			x						
	Undervoltage release – 24	UVR-24	120...127	n/a	3VA9978-0BB24	3	1			x						
	Undervoltage release – 25	UVR-25	208...230	n/a	3VA9978-0BB25	3	1			x						
	Undervoltage release – 27	UVR-27	440...480	n/a	3VA9978-0BB27	3	1			x						
	Universal release	UNI-11	n/a	12vdc	3VA9978-0BD11	3	1			x						
	Universal release	UNI-12	n/a	24vdc	3VA9978-0BD12	3	1			x						
	Universal release	UNI-13	n/a	48vdc	3VA9978-0BD13	3	1			x						
	<b>Internal Accessories</b> Right side or left side options	Auxiliary switch – standard	AUX_HQ	240VAC	n/a	3VA9978-0AA12	1	6	x	x	x	x	x	x	x	x
Auxiliary switch – electronic		AUX_HQ_el	24VAC	24VDC	3VA9978-0AA13	1	6	x	x	x	x	x	x	x	x	
Auxiliary switch – high capacity <sup>①</sup>		AUX_HP	600VAC	n/a	3VA9978-0AA11	2	2	x		x		x		x		
									x				x			
Leading Chg-over SW – standard		LCS_HQ	240VAC	n/a	3VA9978-0AA22	1	1						x			
Leading Chg-over SW – electronic		LCS_HQ_el	24VAC	n/a	3VA9978-0AA23	1	1						x			
Leading Chg-over SW – High Cap <sup>①</sup>		LCS_HP	600VAC	250VDC	3VA9978-0AA21	1	1						x			
Trip alarm (bell alarm) standard		TAS_HQ	240VAC	250VDC	3VA9978-0AB12	1	4			x	x	x	x			
Trip alarm (bell alarm) electronic		TAS_HQ_el	24VAC	24VDC	3VA9978-0AB13	1	4			x	x	x	x			
Trip alarm (bell alarm) High Cap <sup>①</sup>		TAS_HP	600VAC	250VDC	3VA9978-0AB11	2	2			x		x				
<b>External<sup>®</sup> Accessories</b> and field kits	6-350 kcmil AL wire connector Kit <sup>③</sup>	AL-lug	n/a	n/a	3VA9233-0JB12	n/a	n/a	Load end only for P3								
	6-350 kcmil CU wire connector Kit <sup>③</sup>	CU-lug	n/a	n/a	3VA9233-0JD12	n/a	n/a	Load end only for P3								
	P3 3VA52 hardware Kit – includes screw retainers and breaker mounting screws.				BBKVA52P3HW	n/a	n/a	Line end only for P3 – One kit per breaker required.								
	P3 3VA52 Strap Kit – include all mounting hardware for two 3VA52 breakers – 1-phase or 3-phase, twin horizontal mount.				BBKVA52P3T	n/a	n/a	Requires 6 inches of unit space, max. six QR or 3VA52 per panel								
	Compression Lugs (future offering - details tbd)				tbd	n/a	n/a	Availability and usage locations tbd								
	3VA52 PadLock Device (future offering - details tbd)				tbd	n/a	n/a	Availability and usage locations tbd								
	3VA52 Handle Block Device (future offering - details tbd)				tbd	n/a	n/a	Availability and usage locations tbd								

<sup>①</sup> High capacity/power (HP) max. Amps load capacity is higher than standard module (.55A up to 6.0A) depends on Voltage and AC/DC requirements - see SpeedFax section 7 or 3VA documentation for more information.

<sup>②</sup> Many accessories available for the 3VA52 breaker may not be suitable for use in Lighting Panelboards.  
– COMPAS allows options that are available. All accessories listed above can be used with Panelboards.

<sup>③</sup> Lugs are NOT supplied with loose breaker as standard – must order separately or configur in COMPAS to include lugs.  
– Factory assembled panels include AL lugs as standard, CU lugs are optional. These kits include 3 connectors and hardware.

# Panelboards

## Type P4 Panelboards

General

### Features

The P4 panel has a medium sized footprint and fits a larger number of applications that require larger branch devices and higher amp ratings than what the lighting panel class offers. Even with the increased capacity, this panel is a space saver with its 32" width and 10" depth. The P4 panel offers a wide array of factory-assembled options and has the ability to mix breaker frames in unit space up to 800 amps and fusible switches up to 200 amps. Bussing options for the P4 vary from the standard temperature rated aluminum to temperature rated copper and 750A/SI aluminum and 1000A/SI copper designs. All aluminum bussing in the P4 panel is tin-plated as a standard. Silver-plated is offered as the default for copper bus and tin as an option. Integrated time clocks, bus mounted contactors as mains or submains, split bus and subfeed lugs (up to 600 amp) are just a few of the options of this flexible panel.

The 3 panel configurations defined by the unit space allowed for a given amperage, main device and box height. The P4 panel starts with a 60" high box. All of the branch devices are unit space mounted. Breakers and switches can be mixed and matched to meet customer requirements.

### Enclosure Selection<sup>①</sup>

Enclosure Dimension in Inches (mm)			Available Circuit Space in Inches (mm) Dimension "C"	
H	W	D	Main Lug	Main Breaker
Type 1 and Type 3R/12			400-800A	400-800A
60 (1524)	32 (813)	10 (254)	30 (762)	21.25 (540)
75 (1905)	32 (813)	10 (254)	45 (1143)	36.25 (921)
90 (2286)	32 (813)	10 (254)	60 (1524)	51.25 (1302)

### Main Breaker Unit Space Dimensions

Ampere Rating	Breaker Type	Breaker Family	Dimensions in Inches (mm)	
			A	B
400	JXD6, JD6, HJXD6, HJD6, HHJXD6, HHJD6	Sentron	10.425 (265)	13.125 (333)
400	NJ, HJ, LJ <sup>②</sup>	VL	12.500 (318)	
400	SJD6, SHJD6	Sentron	10.425 (265)	
400	CJD6, SCJD6	Sentron	8.250 (210)	
600	LXD6, LD6, HLXD6, HLD6, HHLXD6, HHLD6	Sentron	10.425 (265)	
600	NL, HL, LL <sup>②</sup>	VL	11.250 (286)	
600	SLD6, SHLD6	Sentron	10.425 (265)	
600	CLD6, SCLD6	Sentron	8.250 (210)	
800	NM, HM, LM	VL	10.500 (267)	

<sup>①</sup> Standard trim is four piece without door. Surface or flush one piece trim is available for 32 in. (813 mm) wide circuit breaker panel.  
<sup>②</sup> Solid state (electronic) trip units only.

### Main Lug / Main Breaker

**Enclosure** – Standard Type 1 enclosure is 32" wide x 10" deep. The Box Height is determined by main device and unit space. See charts for box height. Voltage – 600V AC max. 250V DC max.

**Amperage** – 400-800 amp main breaker or 400-1200 amp main lug only.

**Short Circuit Rating** – 200 KAIC max. symmetrical or equal to the lowest rated device installed unless a series rating is indicated. Panels with subfeed or feed-thru lugs without a main device, circuit breaker or fusible unit, are limited to a three-cycle rating. The three-cycle rating for the P4 panel is limited to 42 KAIC. Note that the main device may be mounted remote from the panel.

**Bussing** – The P4 panel has more options to meet market requirements. The standard bussing is temperature rated aluminum. The rating is per the requirements of UL 67 – the standard for panelboards. All aluminum bussing is tin-plated. Optional bussing for the P4 panel is: 750 A/SI aluminum, temperature rated copper, and 1000 A/SI copper. The copper bus option for this panel is silver-plated.

### Weight – Approximate

Total panelboard weight when filled with a normal quantity of breakers and accessories is about 8 lbs. (1 kg) per inch (54g per mm) of box height.

### Main Lugs<sup>①</sup>

Ampere Rating	Connectors Suitable for Copper or Aluminum
400	(1) - #3/0 AWG-500 kcmil (2) - #3/0 AWG-250 kcmil
600	(2) - #3/0 AWG-500 kcmil
800	(3) - #3/0 AWG-500 kcmil
1000	(4) - #3/0 AWG-500 kcmil
1200	(4) - #3/0 AWG-500 kcmil

<sup>①</sup> Alternate lugs for 750 kcmil cable are available, but result in significant loss of branch unit mounting space. Consult Siemens.

### Gauge Steel of Boxes Fronts, Surface and Flush

Dimensions in inches (mm)		Gauge Steel	
Width	Height	Box	Fronts
32" (813)	60 - 75 - 90 (1524, 1905, 2286)	#16 <sup>①</sup>	#14 (1 piece trim) #14 Ga (4 piece trim)
		#12	#12 (1 piece trim, door in door)
		#10	#10 (1 piece door trim in)
		#16	#16 (4 piece trim)

<sup>①</sup> Box has 16 gauge side panels, 14 gauge backplates and 12 gauge back support.

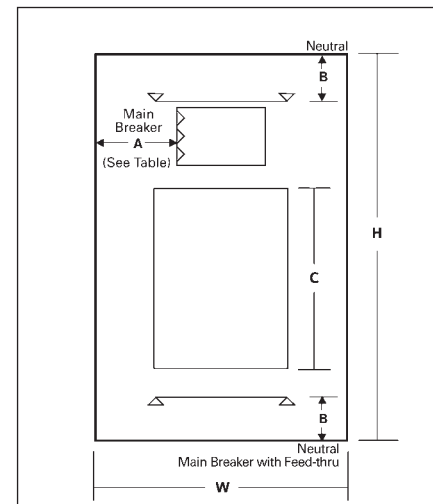

# Panelboards

## Type P4 Panelboards

Dimensions

1  
PANELBOARDS

### Main Breaker Selection

Ampere Rating	Trip Type	Breaker Family	Frame Type	Maximum Interruption Rating (KAIC)			Unit Space Requirements in Inches (mm)	Trip Amperage
				240V	480V	600V		
400	Thermal Magnetic	Sentron	JXD6, JD6	65,000	35,000	25,000	8.75 (222)	200, 225, 250, 300, 350, 400
			HJXD6, HJD6	100,000	65,000	35,000	8.75 (222)	200, 225, 250, 300, 350, 400
			HHJXD6, HHJD6	200,000	100,000	50,000	8.75 (222)	200, 225, 250, 300, 350, 400
			CJD6	200,000	150,000	100,000	8.75 (222)	200, 225, 250, 300, 350, 400
	Electronic (Solid state)	VL	NJ	65,000	35,000	25,000	6.25 (159)	250, 400
			HJ	100,000	65,000	25,000	6.25 (159)	250, 400
			LJ	200,000	100,000	25,000	6.25 (159)	250, 400
		Sentron	SJD6	65,000	35,000	25,000	8.75 (222)	200, 300, 400
			SHJD6	100,000	65,000	35,000	8.75 (222)	200, 300, 400
			SCJD6	200,000	150,000	100,000	8.75 (222)	200, 300, 400
600	Thermal Magnetic	Sentron	LXD6	65,000	35,000	25,000	8.75 (222)	450, 500, 600
			LD6	65,000	35,000	25,000	8.75 (222)	250, 300, 350, 400, 450, 500, 600
			HLXD6, HLD6	100,000	65,000	35,000	8.75 (222)	250, 300, 350, 400, 450, 500, 600
			HHLXD6, HHLD6	200,000	100,000	50,000	8.75 (222)	250, 300, 350, 400, 450, 500, 600
			CLD6	200,000	150,000	100,000	8.75 (222)	250, 300, 350, 400, 450, 500, 600
			NL	65,000	35,000	25,000	6.25 (159)	400, 600
	Electronic (Solid state)	VL	HL	100,000	65,000	25,000	6.25 (159)	400, 600
			LL	200,000	100,000	25,000	6.25 (159)	400, 600
			SLD6	65,000	35,000	25,000	8.75 (222)	300, 400, 500, 600
		Sentron	SHLD6	100,000	65,000	35,000	8.75 (222)	300, 400, 500, 600
			SCLD6	200,000	150,000	100,000	8.75 (222)	300, 400, 500, 600
			NM	65,000	35,000	25,000	8.75 (222)	600, 700, 800
			HM	100,000	65,000	35,000	8.75 (222)	600, 700, 800
			LM	200,000	100,000	50,000	8.75 (222)	600, 700, 800
800	Thermal Magnetic	VL	NM	65,000	35,000	25,000	8.75 (222)	600, 700, 800
			HM	100,000	65,000	35,000	8.75 (222)	600, 700, 800
			LM	200,000	100,000	50,000	8.75 (222)	600, 700, 800
	Electronic (Solid state)	VL	NM	65,000	35,000	25,000	8.75 (222)	600, 800
			HM	100,000	65,000	35,000	8.75 (222)	600, 800
			LM	200,000	100,000	50,000	8.75 (222)	600, 800

### Main Lugs Only Wire Bending Space

Lugs	Dimensions in inches (mm)						
	Main Lug					Neutral	
	400A A	600A B	800A C	1000A D	1200A E	400-600A F	800-1200A G
Standard	16.500 (419)	16.750 (419)	15.969 (406)	15.969 (406)	15.969 (406)	13.125 (333)	13.125 (333)
Oversize	16.500 (419)	21.750 (552)	25.969 (660)	25.969 (660)	25.969 (660)	18.125 (460)	23.125 (587)
Crimp	19.187 (487)	18.250 (464)	18.687 (475)	18.250 (464)	18.250 (464)	15.937 (405)	15.937 (405)
Standard w/Subfeed	16.750 (425)	15.969 (406)	—	—	—	13.125 (333)	13.125 (333)
Standard w/Feed-thru	16.500 (419)	16.750 (419)	—	—	—	13.125 (333)	13.125 (333)

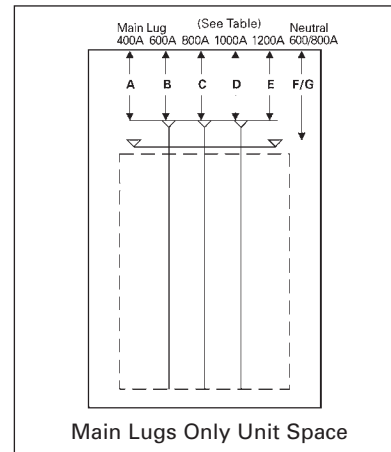

### Branch Switch Unit Space

Ampere Rating	Number of Poles	Mounting Height in inches (mm)		AC Voltage	Cables Per Connector	Connectors Suitable for Copper or Aluminum
		Twin Mounted	Single Mounted			
30-30	2, 3	2.50 (64)	—	240	1	#14 - #8 AWG (Cu Only)
30-30	2, 3	5.00 (127)	—	240	1	#14 - #4 AWG
30-60	2, 3	5.00 (127)	—	240	1	#14 - #4 AWG
60-60	2, 3	5.00 (127)	—	240	1	#14 - #4 AWG
60-100	2, 3	7.50 (191)	—	240	1	#10 - #1/0 AWG
100-100	2, 3	7.50 (191)	—	240	1	#10 - #1/0 AWG
200-200	3	10.00 (254)	—	240	1	#6 AWG - 350 kcmil
200	2	—	7.50 (191)	240	1	#6 AWG - 350 kcmil
200	3	—	10.00 (254)	240	2	#6 AWG - 350 kcmil
30-30	2, 3	7.5 (191)	—	600	1	#14 - #8 AWG
30-60	2, 3	7.5 (191)	—	600	1	#14 - #4 AWG
60-60	2, 3	7.5 (191)	—	600	1	#14 - #4 AWG
60-100	2, 3	7.5 (191)	—	600	1	#10-#1/0 AWG
100-100	2, 3	7.5 (191)	—	600	1	#10-#1/0 AWG
200-200	3	10.00 (254)	—	600	1	#6 AWG - 250 kcmil
100	2, 3	—	7.50 (191)	600	1	#10-#1/0 AWG
200	2, 3	—	10.00 (254)	600	1	#6 AWG - 250 kcmil

# Panelboards

## Type P4 Panelboards

## Dimensions

### Branch Breaker Side Gutter Inches (mm)

Reference Letter	Panel Width 32 Inches Dimensions in inches (mm)
A	11.0 (279)
B	10.98 (279)
C	8.62 (219)
D	7.0 (178)
E	5.75 (146)
F	5.25 (133)
H	4.62 (117)
I	8.76 (223)
J	10.42 (265)
K	10.0 (254)
L	8.25 (210)
M	10.0 (254)
N	7.0 (178)
O	5.0 (127)
P	7.50 (191)
Q	7.9 (200)
R	7.9 (200)
S	2.5 (318)
T	11.25 (286)

← A →	BL, BLH, HBL, BQD, BLE, BLEH, BLR, BLF2, BLHF2, HBLF2, BLFB, BLHFB, BAF, BAHF, BGL, BQD	BL, BLH, HBL, BQD, BLE, BLEH, BLR, BLF2, BLHF2, HBLF2, BLFB, BLHFB, BAF, BAHF, BGL, BQD	← A →
← B →	NGB, HGB, LGB NGB2, HGB2, LGB2	NGB, HGB, LGB NGB2, HGB2, LGB2	← B →
← D →	ED4, ED6, HED4	ED4, ED6, HED4	← D →
← H →	CED	CED	← H →
← E →	QR2, QRH2, HQR2, HQR2H	QR2, QRH2, HQR2, HQR2H	← E →
← F →	FXD6, FD6, HFXD6, HFD6, HHFXD6, HHFD6, SFD6, SHFD6	FXD6, FD6, HFXD6, HFD6, HHFXD6, HHFD6, SFD6, SHFD6	← F →
← Q →	ND, HD, LD	ND, HD, LD	← Q →
← R →	NF, HF, LF	NF, HF, LF	← R →
← I →	CFD6, SCFD6		← I →
← J →	JD6, JXD6, SJD6, HJD6, HXJD6, SHJD6, HHJD6, HHJXD6, LD6, LXD6, SLD6, HLD6, HXLD6, SHLD6, HHLXD6		← J →
← L →	CJD6, SCJD6, CLD6, SCLD6		← L →
← S →	NJ, HJ, LJ		← S →
← T →	NL, HL, LL		← T →
← K →	NM, HM, LM		← K →
← M →	VB 30A, VB 60A (5")	VB 30A, VB 60A (5")	← M →
← N →	VB 30A, VB 60A (5")	VB 30A, VB 60A (5")	← N →
← O →	VB 100 - 200A	VB 100 - 200A	← O →
← P →	VB 100 - 200A Single		← P →



# Panelboards

## Type P4

### Shown with Standard Mains, Top Fed and Surface Trim

Catalog number is for aluminum main bus. For optional copper main bus change "A" in position 11 to "E" (silver-plated copper bus).

Panels are top feed, surface mounted. For bottom feed, change "T" in position 12 to "B". For flush mounting, change "S" in position 13 to "F".

Replace fifth and sixth position in panelboard catalog number, with alternate main breaker code. Use price adders from main breaker section table. Horizontally mounted.

### Main Lugs Only — shown with aluminum bus, top fed, and surface trims.

Maximum Panel Amps	Unit Space (inches)	208Y/120V	240/120V	120/240V or 250 V DC Max
		3-Phase, 4-Wire Catalog Number	3-Phase, 4-Wire Catalog Number	1-Phase, 3-Wire Catalog Number
400	30	P4C60ML400ATS	P4B60ML400ATS	P4A60ML400ATS
	45	P4C75ML400ATS	P4B75ML400ATS	P4A75ML400ATS
	60	P4C90ML400ATS	P4B90ML400ATS	P4A90ML400ATS
600	30	P4C60ML600ATS	P4B60ML600ATS	P4A60ML600ATS
	45	P4C75ML600ATS	P4B75ML600ATS	P4A75ML600ATS
	60	P4C90ML600ATS	P4B90ML600ATS	P4A90ML600ATS
800	30	P4C60ML800ATS	P4B60ML800ATS	P4A60ML800ATS
	45	P4C75ML800ATS	P4B75ML800ATS	P4A75ML800ATS
	60	P4C90ML800ATS	P4B90ML800ATS	P4A90ML800ATS
1000	30	P4C60ML101ATS	P4B60ML101ATS	P4A60ML101ATS
	45	P4C75ML101ATS	P4B75ML101ATS	P4A75ML101ATS
	60	P4C90ML101ATS	P4B90ML101ATS	P4A90ML101ATS
1200	30	P4C60ML120ATS	P4B60ML120ATS	P4A60ML120ATS
	45	P4C75ML120ATS	P4B75ML120ATS	P4A75ML120ATS
	60	P4C90ML120ATS	P4B90ML120ATS	P4A90ML120ATS
Maximum Panel Amps	Unit Space (inches)	240V	480Y/277V	480V <sup>Ⓞ</sup>
		3-Phase, 3-Wire Catalog Number	3-Phase, 4-Wire Catalog Number	3-Phase, 3-Wire Catalog Number
400	30	P4D60ML400ATS	P4E60ML400ATS	P4F60ML400ATS
	45	P4D75ML400ATS	P4E75ML400ATS	P4F75ML400ATS
	60	P4D90ML400ATS	P4E90ML400ATS	P4F90ML400ATS
600	30	P4D60ML600ATS	P4E60ML600ATS	P4F60ML600ATS
	45	P4D75ML600ATS	P4E75ML600ATS	P4F75ML600ATS
	60	P4D90ML600ATS	P4E90ML600ATS	P4F90ML600ATS
800	30	P4D60ML800ATS	P4E60ML800ATS	P4F60ML800ATS
	45	P4D75ML800ATS	P4E75ML800ATS	P4F75ML800ATS
	60	P4D90ML800ATS	P4E90ML800ATS	P4F90ML800ATS
1000	30	P4D60ML101ATS	P4E60ML101ATS	P4F60ML101ATS
	45	P4D75ML101ATS	P4E75ML101ATS	P4F75ML101ATS
	60	P4D90ML101ATS	P4E90ML101ATS	P4F90ML101ATS
1200	30	P4D60ML120ATS	P4E60ML120ATS	P4F60ML120ATS
	45	P4D75ML120ATS	P4E75ML120ATS	P4F75ML120ATS
	60	P4D90ML120ATS	P4E90ML120ATS	P4F90ML120ATS

### Main Circuit Breaker — shown with standard mains, aluminum bus, top fed, and surface trims.

Maximum Panel Amps	Unit Space (inches)	208Y/120V	240/120V	120/240V or 250 Vdc Max
		3-Phase, 4-Wire Catalog Number	3-Phase, 4-Wire Catalog Number	1-Phase, 3-Wire Catalog Number
400	21.25	P4C60JX400ATS	P4B60JX400ATS	P4A60JX400ATS
	36.25	P4C75JX400ATS	P4B75JX400ATS	P4A75JX400ATS
	51.25	P4C90JX400ATS	P4B90JX400ATS	P4A90JX400ATS
600	21.25	P4C60LX600ATS	P4B60LX600ATS	P4A60LX600ATS
	36.25	P4C75LX600ATS	P4B75LX600ATS	P4A75LX600ATS
	51.25	P4C90LX600ATS	P4B90LX600ATS	P4A90LX600ATS
800	21.25	P4C60M1800ATS	P4B60M1800ATS	P4A60M1800ATS
	36.25	P4C75M1800ATS	P4B75M1800ATS	P4A75M1800ATS
	51.25	P4C90M1800ATS	P4B90M1800ATS	P4A90M1800ATS
Maximum Panel Amps	Unit Space (inches)	240V	480Y/277V	480V <sup>Ⓞ</sup>
		3-Phase, 3-Wire Catalog Number	3-Phase, 4-Wire Catalog Number	3-Phase, 3-Wire Catalog Number
400	21.25	P4D60JX400ATS	P4E60JX400ATS	P4F60JX400ATS
	36.25	P4D75JX400ATS	P4E75JX400ATS	P4F75JX400ATS
	51.25	P4D90JX400ATS	P4E90JX400ATS	P4F90JX400ATS
600	21.25	P4D60LX600ATS	P4E60LX600ATS	P4F60LX600ATS
	36.25	P4D75LX600ATS	P4E75LX600ATS	P4F75LX600ATS
	51.25	P4D90LX600ATS	P4E90LX600ATS	P4F90LX600ATS
800	21.25	P4D60M1800ATS	P4E60M1800ATS	P4F60M1800ATS
	36.25	P4D75M1800ATS	P4E75M1800ATS	P4F75M1800ATS
	51.25	P4D90M1800ATS	P4E90M1800ATS	P4F90M1800ATS

<sup>Ⓞ</sup> For 600V application, change "F" in position 3 to "G". See alternate main breaker table on page 11-58 for 600V rated mains. Change position 5 and 6 and add price from table. Price only 600V rated branch breakers.

# Panelboards

Power and Distribution

Selection

PANELBOARDS 11

## Type P4

### Alternate Main Breaker Selection

Breaker Frame Rating	Trip Type	Breaker Family	Frame Type	Alternate Main Breaker Code	Trip Amperage	Unit Space Requirements in Inches	Maximum Interruption Rating (KAIC) Volts AC			
							240	480	600	
400	Thermal Magnetic	Sentron	JXD6	JX	200, 225, 250, 300, 350, 400	8.75	65,000	35,000	25,000	
			JD6	J6	200, 225, 250, 300, 350, 400	8.75	65,000	35,000	25,000	
			HJXD6	H5	200, 225, 250, 300, 350, 400	8.75	100,000	65,000	35,000	
			HJD6	H6	200, 225, 250, 300, 350, 400	8.75	100,000	65,000	35,000	
			HHJXD6	H9	200, 225, 250, 300, 350, 400	8.75	200,000	100,000	50,000	
			HHJD6	6H	200, 225, 250, 300, 350, 400	8.75	200,000	100,000	50,000	
			CJD6	CJ	200, 225, 250, 300, 350, 400	8.75	200,000	150,000	100,000	
	Electronic (Solid state)	VL	Sentron	NJ	J1	250, 400	6.25	65,000	35,000	25,000
				HJ	J7	250, 400	6.25	100,000	65,000	25,000
				LJ	J3	250, 400	6.25	200,000	100,000	25,000
		Sentron	SJD6	SJ	200, 300, 400	8.75	65,000	35,000	25,000	
			SHJD6	SX	200, 300, 400	8.75	100,000	65,000	35,000	
			SCJD6	SC	200, 300, 400	8.75	200,000	150,000	100,000	
			LXD6	LX	450, 500, 600	8.75	65,000	35,000	25,000	
600	Thermal Magnetic	Sentron	LD6	L6	250, 300, 350, 400, 450, 500, 600	8.75	65,000	35,000	25,000	
			HLXD6	HO	250, 300, 350, 400, 450, 500, 600	8.75	100,000	65,000	35,000	
			HLD6	HL	250, 300, 350, 400, 450, 500, 600	8.75	100,000	65,000	35,000	
			HHLXD6	XH	250, 300, 350, 400, 450, 500, 600	8.75	200,000	100,000	50,000	
			HHLD6	HH	250, 300, 350, 400, 450, 500, 600	8.75	200,000	100,000	50,000	
			CLD6	CL	250, 300, 350, 400, 450, 500, 600	8.75	200,000	150,000	100,000	
			Electronic (Solid state)	VL	Sentron	NL	L7	400, 600	6.25	65,000
	HL	L2				400, 600	6.25	100,000	65,000	25,000
	LL	SL				400, 600	6.25	200,000	100,000	25,000
	Sentron	SLD6		L6	300, 400, 500, 600	8.75	65,000	35,000	25,000	
		SHLD6		S2	300, 400, 500, 600	8.75	100,000	65,000	35,000	
		SCLD6		SI	300, 400, 500, 600	8.75	200,000	150,000	100,000	
		800		Thermal Magnetic	VL	NM	M1	600, 700, 800	8.75	65,000
	HM		M2			600, 700, 800	8.75	100,000	65,000	35,000
LM	M3		600, 700, 800			8.75	200,000	100,000	50,000	
Sentron	LMXD6		LM		500, 600, 700, 800	8.75	65,000	50,000	25,000	
	LMD6		L1		500, 600, 700, 800	8.75	65,000	50,000	25,000	
	HLMXD6		HK		500, 600, 700, 800	8.75	100,000	65,000	50,000	
Electronic (Solid state)	VL		Sentron	HLMD6	HJ	500, 600, 700, 800	8.75	100,000	65,000	50,000
				NM	M1	600, 800	8.75	65,000	35,000	25,000
				HM	M2	600, 800	8.75	100,000	65,000	35,000
				LM	M3	600, 800	8.75	200,000	100,000	50,000

For inches / millimeters conversion, see Application Data section.

# Panelboards

Power and Distribution

Selection

## Branch Breaker Selection<sup>①</sup>

Breaker Frame Rating	Trip Type	Breaker Family	Frame Type	Poles	Trip Amperage	Unit Space Requirements in Inches		Maximum Interruption Rating (KAIC) Volts AC								
						Single	Twin	120	240	480V/277	480	600V/347	600			
100	Thermal Magnetic	General Application	BL	1, 2, 3	15-60, 70, 80, 90, 100	—	3.75 <sup>②③</sup>	10,000	10,000	—	—	—	—			
			BLR	2	15, 20, 30, 40, 50, 60, 70, 80, 90, 100	—	3.75 <sup>②③</sup>	10,000	10,000	—	—	—	—			
			BLH	1, 2, 3	15-60, 70, 80, 90, 100	—	3.75 <sup>②③</sup>	22,000	22,000	—	—	—	—			
			HBL	1, 2, 3	15-60, 70, 80, 90, 100	—	3.75 <sup>②③</sup>	65,000	65,000	—	—	—	—			
			BQD	1, 2, 3	15-50, 60, 70, 80, 90, 100	—	3.75 <sup>②③</sup>	65,000	65,000	14,000	—	—	—			
			BQD6 <sup>④</sup>	1, 2, 3	15-50, 60, 70	—	3.75 <sup>②③</sup>	65,000	65,000	—	—	10,000	—			
	Special Application Ground Fault Circuit Interrupter Arc Fault Circuit Interrupter		BL-HID	1, 2	15, 20, 30	—	3.75 <sup>②③</sup>	10,000	10,000	—	—	—	—			
			BL-BG	2, 3	15, 20, 30	—	3.75 <sup>②③</sup>	10,000	10,000	—	—	—	—			
			BLE-GFCI	1, 2	15, 20, 30, 40, 50, 60	—	3.75 <sup>②</sup>	10,000	10,000	—	—	—	—			
			BLEH-GFCI	1, 2	15, 20, 30, 40, 50, 60	—	3.75 <sup>②</sup>	10,000	10,000	—	—	—	—			
			BLF-GFCI	1, 2	15, 20, 30, 40, 50, 60	—	3.75 <sup>②</sup>	10,000	10,000	—	—	—	—			
			BLHF-GFCI	1, 2	15, 20, 30, 40, 50, 60	—	3.75 <sup>②</sup>	10,000	10,000	—	—	—	—			
			BAF-AFCI	1, 2	15, 20	—	3.75 <sup>②</sup>	10,000	10,000	—	—	—	—			
			BAFH-AFCI	1, 2	15, 20	—	3.75 <sup>②</sup>	10,000	10,000	—	—	—	—			
125	Thermal Magnetic	General Application	NGB	1, 2, 3	15-60, 70, 80, 90, 100, 110, 125	—	3.75 <sup>②③</sup>	—	100,000	25,000	—	14,000	—			
			HGB	1, 2, 3	15-60, 70, 80, 90, 100, 110, 125	—	3.75 <sup>②③</sup>	—	100,000	35,000	—	14,000	—			
			LGB	1, 2, 3	15-60, 70, 80, 90, 100, 110, 125	—	3.75 <sup>②③</sup>	—	100,000	65,000	—	14,000	—			
			NGB2	1, 2, 3	15-60, 70, 80, 90, 100, 110, 125	—	3.75 <sup>②③</sup>	—	100,000	—	25,000	14,000	—			
			HGB2	1, 2, 3	15-60, 70, 80, 90, 100, 110, 125	—	3.75 <sup>②③</sup>	—	100,000	—	35,000	22,000	—			
			LGB2	1, 2, 3	15-60, 70, 80, 90, 100, 110, 125	—	3.75 <sup>②③</sup>	—	100,000	—	65,000	25,000	—			
			ED4	1, 2, 3	15-50, 60, 70, 80, 90, 100, 110, 125	—	3.75 <sup>②③</sup>	—	65,000	—	18,000	—	—			
			HED4 <sup>④⑤</sup>	1, 2, 3	15-50, 60, 70, 80, 90, 100, 110, 125	—	3.75 <sup>②③</sup>	—	100,000	—	42,000	—	—			
			HHED6	1, 2, 3	15-50, 60, 70, 80, 90, 100, 110, 125	—	3.75 <sup>②③</sup>	—	100,000	—	65,000	—	18,000			
			CED6 <sup>⑦</sup>	2, 3	20-50, 60, 70, 80, 90, 100, 110, 125	—	3.75 <sup>②③</sup>	—	200,000	—	200,000	—	100,000			
			150	Electronic (Solid state)	VL	ND	3	60, 100, 150	—	5.00	—	65,000	—	35,000	—	18,000
						HD	3	60, 100, 150	—	5.00	—	100,000	—	65,000	—	20,000
						LD	3	60, 100, 150	—	5.00	—	200,000	—	100,000	—	25,000
			225	Thermal Magnetic	General Application	QR2	2, 3	100, 110, 125, 150, 175, 200, 225	—	5.00	—	10,000	—	—	—	—
QRH2	2, 3	100, 110, 125, 150, 175, 200, 225				—	5.00	—	25,000	—	—	—	—			
HQR2	2, 3	100, 110, 125, 150, 175, 200, 225				—	5.00	—	65,000	—	—	—	—			
HQR2H	2, 3	100, 110, 125, 150, 175, 200, 225				—	5.00	—	100,000	—	—	—	—			
CFD6	3	70-110, 125, 150, 175, 200, 225, 250				5.00	5.00	—	65,000	—	35,000	—	22,000			
250	Thermal Magnetic	Sentron	HFXD6, HFD6	2, 3	70-110, 125, 150, 175, 200, 225, 250	5.00	5.00	—	100,000	—	65,000	—	25,000			
			HFXD6, HFD6	2, 3	70-110, 125, 150, 175, 200, 225, 250	5.00	5.00	—	200,000	—	100,000	—	25,000			
			CFD6	3	70-110, 125, 150, 175, 200, 225, 250	—	5.00	—	200,000	—	200,000	—	100,000			
			NF	3	100, 150, 250	5.00	5.00	—	65,000	—	35,000	—	18,000			
	Electronic (Solid state)		VL	HF	3	100, 150, 250	5.00	5.00	—	100,000	—	65,000	—	20,000		
				LF	3	100, 150, 250	5.00	5.00	—	200,000	—	100,000	—	25,000		
				400	Thermal Magnetic	Sentron	JXD6, JD6	2, 3	200, 225, 250, 300, 350, 400	8.75	—	—	65,000	—	35,000	—
HJXD6, HJD6	2, 3	200, 225, 250, 300, 350, 400	8.75				—	—	100,000	—	65,000	—	35,000			
HHJXD6, HHJD6	2, 3	200, 225, 250, 300, 350, 400	8.75				—	—	200,000	—	100,000	—	50,000			
CJD6	3	200, 225, 250, 300, 350, 400	8.75				—	—	200,000	—	150,000	—	100,000			
Electronic (Solid state)	VL	NJ	3		250, 400		6.25	—	—	65,000	—	35,000	—	25,000		
		HJ	3		250, 400		6.25	—	—	100,000	—	65,000	—	25,000		
600	Thermal Magnetic	Sentron	LJ	3	250, 400	6.25	—	—	200,000	—	100,000	—	25,000			
			SJD6	3	200, 300, 400	8.75	—	—	65,000	—	35,000	—	25,000			
			SHJD6	3	200, 300, 400	8.75	—	—	100,000	—	65,000	—	35,000			
			SCJD6	3	200, 300, 400	8.75	—	—	200,000	—	150,000	—	100,000			
			LXD6	2, 3	450, 500, 600	8.75	—	—	65,000	—	35,000	—	25,000			
			LD6	2, 3	250, 300, 350, 400, 450, 500, 600	8.75	—	—	65,000	—	35,000	—	25,000			
	Electronic (Solid state)		VL	HLXD6, HLD6	2, 3	250, 300, 350, 400, 450, 500, 600	8.75	—	—	100,000	—	65,000	—	35,000		
				HHLXD6, HHLDD6	2, 3	250, 300, 350, 400, 450, 500, 600	8.75	—	—	200,000	—	100,000	—	50,000		
				CLD6	3	250, 300, 350, 400, 450, 500, 600	8.75	—	—	200,000	—	150,000	—	100,000		
				NL	3	400, 600	6.25	—	—	65,000	—	35,000	—	25,000		
				HL	3	400, 600	6.25	—	—	100,000	—	65,000	—	25,000		
				LL	3	400, 600	6.25	—	—	200,000	—	100,000	—	25,000		
				SLD6	3	300, 400, 500, 600	8.75	—	—	65,000	—	35,000	—	25,000		
				SHLD6	3	300, 400, 500, 600	8.75	—	—	100,000	—	65,000	—	35,000		
800	Thermal Magnetic	VL	SCLD6	3	300, 400, 500, 600	8.75	—	—	200,000	—	150,000	—	100,000			
			NM	2, 3	600, 700, 800	8.75	—	—	65,000	—	35,000	—	25,000			
			HM	2, 3	600, 700, 800	8.75	—	—	100,000	—	65,000	—	35,000			
	LM		2, 3	600, 700, 800	8.75	—	—	200,000	—	100,000	—	50,000				
	Electronic (Solid state)		VL	NM	3	600, 800	8.75	—	—	65,000	—	35,000	—	25,000		
				HM	3	600, 800	8.75	—	—	100,000	—	65,000	—	35,000		
LM		3		600, 800	8.75	—	—	200,000	—	100,000	—	50,000				

① Space price covers cost of housing frame plate with blank cover plate. Provision price includes all necessary mounting hardware, less circuit breaker, and includes housing frame cover plate with breaker handle opening.

② 1 to 6 poles may be mounted in 3.75" of unit space.  
 ③ Accessories such as shunt trips on three pole breakers require 6.25" of unit space.  
 ④ HED4 1-pole 15-30A = 65,000 IR  
 35-100A = 25,000 IR

⑤ HED 4 3-Pole=42,000 IR  
 ⑥ BQD6 is not UL Listed. Only for CUL and CSA panels.  
 ⑦ ED6/CED6 2-pole limited amps available (20-50A).

# Panelboards

Power and Distribution

Selection

## Branch Switch Selection

Ampere Rating	Mounting Height (inches)
<b>240V — Twin Mounted NEC Fuse Clips<sup>②</sup></b>	
30-30	2½ <sup>③</sup>
30-30	5
30-60	5
60-60	5
60-100	7½
100-100	7½
200-200	10
<b>240V — Single Mounted NEC Fuse Clips<sup>②</sup></b>	
30	7½
60	7½
100	7½
200	10
200	7½

Ampere Rating	Mounting Height (inches)
<b>600V — Twin Mounted NEC Fuse Clips<sup>②</sup></b>	
30-30	7½
30-60	7½
60-60	7½
60-100	7½
100-100	7½
200-200	10
<b>600V — Single Mounted NEC Fuse Clips<sup>②</sup></b>	
100	7½
200	10

Type S4/P4/SPP (10" deep)  
and F1/P4/FPP (10" deep)

Connecting Strap Kits — w/o Circuit Breaker

For use with Type P4, Type S4 or Sentron SPP Shallow depth panelboards					
Max Amp Rating	Breaker Family	Breaker Type	Catalog Number <sup>①</sup>	Unit Height (inches)	Mounting
100	General	BL, BQD	SBL	3.75	Twin
125	General	NGB, HGB, LGB	SNB	3.75	Twin
	General	NGB2, HGB2, LGB2	SGB2	3.75	Twin
	General	ED	SE6	3.75	Twin
	General	CED	SCE	3.75	Twin
150	VL	DG	SDG	5.00	Twin
225	General	QR <sup>②</sup>	SQR	5.00	Twin
250	VL	FG	SFG	5.00	Twin
	Sentron	FD	SF6	5.00	Twin
	Sentron	CFD	SCF	5.00	Single
400	VL	JG	SJG	6.25	Single
	Sentron	JD	SJ1	8.75	Single
	Sentron	CJD	SCJ	8.75	Single
	Sentron	SJD	SSJ1	8.75	Single
	Sentron	SCJD	SSCJ	8.75	Single
600	VL	LG	SLG	6.25	Single
	Sentron	LD	SL6	8.75	Single
	Sentron	CLD	SCL	8.75	Single
	Sentron	SLD	SSL6	8.75	Single
	Sentron	SCLD	SSCL	8.75	Single
800	VL	MG	MG1	8.75	Single

## Cover Plates

For use with Sentron Shallow Depth or Type SPP/FPP/F1/P4 power panels	
Breaker Type	Catalog Number
QR	SQRC <sup>⑥</sup>

## Service Entrance Barriers

Field installable Barriers to meet UL 67 service entrance requirements	
Breaker Type	Catalog Number
(S)JD, (S)LD, MG	SEBP4V1
CJD, CLD	SEBP4V2
JG, LG	SEBP4V3

For inches / millimeters conversion, see Application Data section.

- ① Includes housing frame plate without breaker handle opening. Provisions include all necessary mounting hardware less breakers.  
 ② For Class J, R or T fuse clip prices, refer to page 11-61.  
 ③ For Class J fuse clips price 600V, 7½" high units.

- ④ NEC fuse clips only.  
 ⑤ Normal stock item.  
 ⑥ Suitable to replace QF3 in P1 thru P5 Panelboards and Switchboards.

- ⑦ To replace a QJ with a QR only a new cover is needed up to 225A  
 ⑧ Although QR is rated 250A, it is limited to 225A in panelboard.

## Blank Plates — Circuit Breaker and Vacu-Break

For use with Type P4, Type S4 or Sentron SPP Shallow depth panelboards	
Height (inches)	Catalog Number
1.25	6FPB01
2.5	6FPB02
3.75	6FPB03
5.0	6FPB05
10.0	6FPB10

## Filler Plates

For use with Type P4, Type S4 or Sentron SPP Shallow depth panelboards	
Breaker Type	Filler Plate Catalog Number
BL, BLH, HBL ED4, ED6, HED4, HHED6, NGB, HGB, LGB, NGB2, HGB2, LGB2	DFFP1 <sup>⑤</sup>
NEB, HEB	EBF1

## Connecting Strap Kits<sup>④</sup>

### Fusible

For use with Sentron Shallow Depth or Type SPP/FPP/F1/P4 power panels		
Ampere Rating	Unit Height (inches)	10" Deep Box
		Catalog Number
30-30	2.5	F602
30-60	5, 7.5	F657
30-60	5, 7.5	F657
60-60	5, 7.5	F657
60-100	5, 7.5	F657
100-100	5, 7.5	F657
100	7.5	F657
200	10	F671
200-200	10	F672

# Panelboards

## Modifications and Additions

## Selection

### P4 Panelboards

#### Devices Mounted on Gutter Cover Includes Device, Mounting – Wired or Unwired

Description
One piece front with door
Hinged Gutter Covers 4 pc front
Toggle Switch — SPST or 3-way
15A, 277V maximum
Pilot Light — General Purpose
Neon or Incandescent
Pushbutton

#### Increased Capacity Neutral

Ampere Rating		Unit Space (inches)
Phase	Neutral	
400	600	0
400	800	0
600	1200	0
800	1200	0

#### Subfeed or Feed-Thru Lugs (One Set Per Panel) Subfeed Double Lugs (Main Lug Panels)

Amp Rating	Unit Spaces (Additional inches)
	MLO
400	0
600	0
800	N/A
1200	N/A

#### Feed-Thru Lugs

Ampere Rating	Unit Space (inches)
400	10
600	10
800	17.5
1200	17.5

#### Grounding of Panelboards Ground Bars (except for brazed-to-box) are shipped with the panel interior factory mounted.

- Non-Insulated Equipment Ground Bar – Standard
- Copper Non-Insulated Ground Bar
- Al Insulated Equipment Ground Bar
- Cu Insulated Equipment Ground Bar
- Ground Bar Brazed to Box

#### Fuse Clip Provisions (Add to 250 Volts or 600 Volts Unit Prices Per Switch)

Amp Rating	Class J	Class R	Class T
30		•	•
60		•	•
100		•	•
200		•	•

#### Spanner Wrenches (for Vacu-Break Switches)

#### Ground Fault on Main Breaker

Description
Conventional Ground Fault <sup>①</sup> Includes: ground fault relay, ground sensor, CPT & shunt trip
Test and Monitor Panel <sup>②</sup>
Ground Fault add to Sensitrip III breaker price

#### Time Clocks <sup>③</sup>

Sangamo, Tork or Paragon time clock can be supplied, mounted in panelboard cabinet. For required increase in enclosure dimension, consult local sales office.

Description
Time clock (1- or 2-Pole, Single or Double Throw Contacts; 3-Pole Single Throw)
277V Maximum with Plain Dial
Optional: Astronomical Dial An Omitting Device Reserve Power or Carryover
Space and Mounting Provisions Only

#### Circuit Breaker Accessories Handle Blocking Device Blocks handle in either the "ON" or "OFF" position.

#### Padlocking Device – Padlocks in "OFF" position.

#### Main Bus

Standard main bus and ground bus are tin-plated aluminum. For copper main bus, neutral bus and ground bus, add from the table for each panel.

#### Lugs – For Main Lug Only Panels

Standard main lugs and neutral lugs are tin-plated aluminum, UL listed for use with aluminum/copper cables. Copper only lugs are an option.

Ampere Rating
400 - 1200

#### Shunt Trip on Main and Branches <sup>④</sup>

Description
BL, BQD, NGB, HGB, LGB, NGB2, HGB2, LGB2 (branch only)
QR2, QRH2, HQR2, HQR2H, ED4, ED6, HED4, HHED6, CED6
All others to 800A

#### 100% Rated Main Circuit Breakers

Ampere Rating	Breaker Type
400A	JXD6H, HJXD6H
	SCJD6H, SHJD6H
	NJY, HJY, LJY
600A	LXD6H, HLXD6H
	NMY <sup>⑤</sup> , HMY <sup>⑤</sup> , LMY <sup>⑤</sup>

<sup>①</sup> Available in 90" high enclosure only. Unit space is 42 1/2" with Test and Monitor Panel; 45" without Test and Monitor Panel.

<sup>②</sup> Not available on Sensitrip III.

<sup>③</sup> For required unit space, consult local sales office.

<sup>④</sup> Shunt Trip on 100A frame breakers increases mounting height to 6.25" for twin mounting.

<sup>⑤</sup> The 600A, 100% rated breaker requires the use of an 800A frame breaker.

# Panelboards

Embedded Micro Metering Module™

Selection

## SEM3 System configured in Panelboards

The Siemens SEM3 system can be configured for factory installation in branch circuit monitoring applications using the Siemens COMPAS configuration tool. This option can lower the installation time of the system for the installer while providing a factory warranted solution.

The SEM3 system can be factory installed in unit space in type P2, P4, & P5 Siemens panel boards. Please note P1 and P3 configurations are not available at this time and the amount of unit space needed varies depending upon the application. Please note that lead time adders will apply and may vary depending upon the configuration of the system.

## SEM3 for use in Siemens Panelboards

### Available in a NEMA 1, 3R, or 12 rated enclosure



#### Controller

SEM3 controller is mounted in unit space opposite of the feed location specified in COMPAS (i.e., bottom mount for top feed) and will require 3" of unit space. Each controller will be powered by direct tap connection to the panel section bus. Each controller can monitor up to 45 circuits. Applications that require monitoring more than 45 circuits will require additional controllers.



#### Current Transformers (CTs)

Five sizes of CTs are available for use in the P4 panel: 50, 125, 250, 400, 500, 600, 800 & 1200 amp. All CTs are pre-mounted to a support bracket that attaches to the base rail of the interior of the panel board. Each bracket supports a maximum of 3 CTs and is designed for the breaker selected (brackets are not interchangeable between breaker frames). Each CT will be attached to a data module that is placed in the meter racks.



#### Meter Racks

Each meter rack requires 3" of unit space. All meter racks will be installed next to the SEM3 controller in unit space. The COMPAS configuration tool will select the appropriate meter rack configuration according to the user's application and will use the 21 space meter rack as a default option where possible. Only one meter rack (regardless of number of positions) can be installed in 3" of unit space.

**NOTE:** Monitoring of 45 circuits will require 9" of unit space: two 21 position racks and one 3 position rack

#### Other Considerations

**Configuration:** Data modules from CTs monitoring a circuit breaker must be mounted adjacent to one another in the meter rack. Any field changes to the factory configuration must take this into account.

**Start-up & Commissioning:** Siemens can provide these services. Contact your local SIEMENS PDS Power Solutions Business Developer for more details.

**Billing Services for sub billing applications:** Billing services are available. Contact your local SIEMENS PDS Power Solutions Business Developer for more details.

## P4 Devices Enclosure sizes

### Example P4 Panel with SEM3 Type 1 Enclosure P4 = (32" Wide x 10" Deep)

Enclosure heights are in 15" increments from 60" thru 90".  
Enclosure heights: 60", 75", 90" (there are optional depths also)

The COMPAS configuration tool can provide actual dimensions based on the configuration. Example below is largest standard P4 enclosure for factory assembled panel - unit space is in 3.75" increments - up to 6 circuits can occupy each 3.75" of unit space.

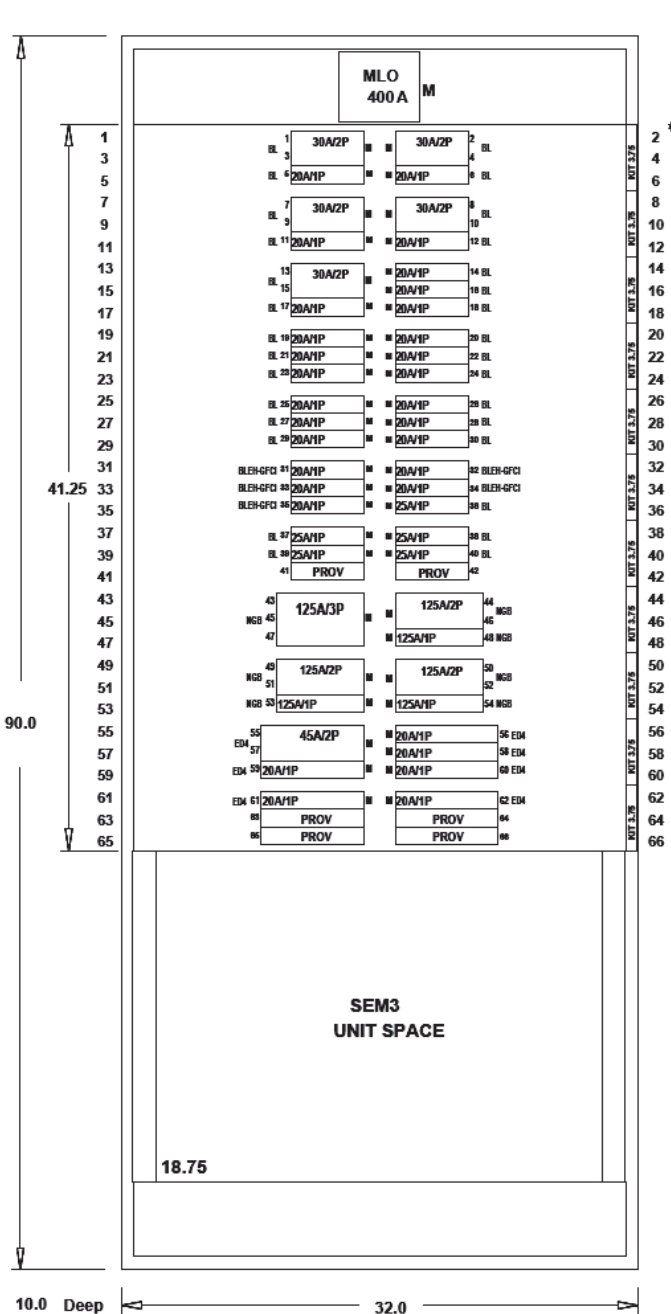

← 32" std. width for P4 →

**Main Breaker / Main Lug space varies based on selected options**

**Unit space varies based on selected options**

**Note:** All circuits do not have to be monitored by SEM3 - user can select any circuits in this space to be monitored.

Based on smallest branch breakers and a 3-phase main being monitored. There is a maximum of 63 circuits that can be monitored with the configuration shown. Some selections of main breakers and other subfeed options could limit this further.

In this situation there is 37.5" of unit space available - so 60 branch circuits could be monitored. If monitoring the main three additional circuits could be monitored with a total of 63 circuits.

This requires two controllers and three 21 position racks using 18.75" of unit space. - see below -

**SEM3 space varies by number of circuits monitored - this uses unit space.**

- == > 7.5" of space for up to 21 circuits monitored one controller and one 21-pos rack
- == > 11.25" of space for up to 42 circuits monitored one controller and two 21-pos racks
- == > 15" of space for up to 45 circuits monitored one controller and two 21-pos racks plus one 3-pos rack
- == > 18.75" of space for up to 63 circuits monitored two controllers and three 21-pos racks

**Note:** If subfeed space is needed - it will take away from available unit space.

## Lug Modifications

### Compression Lugs

Style	Amp Rating	Breaker Type	Compression Connectors	Available Unit Space Reduction
MLO	400	N/A	All compression lugs	Deduct 5.0" of Unit Space
	600	N/A	All compression lugs	
	800	N/A	All compression lugs	
	1000	N/A	All compression lugs	
	1200	N/A	All compression lugs	
Main Breaker	400	JD6, JXD6, HJD6, HJXD6, HHJD6, HHJXD6, CJD6, SJD6, SHJD6, SCJD6	(2)#2/0 AWG - 500 Kcmil Cu or Al	Deduct 0" of Unit Space
		LD6, LXD6, HLD6, HLXD6, NL, HL, LL	(1)#6 - 350 Kcmil Cu or Al	
Main Breaker	600	HHL6, HHLXD6, CLD6, SLD6, SHLD6, SCLD6	(2)#2/0 AWG - 500 Kcmil Cu or Al	Deduct 0" of Unit Space
		NJ, HJ, LJ	(2)#6 - 350 Kcmil Cu or Al	

### Alternate Lugs

Amp Rating	Breaker Type	Compression Connectors	Available Unit Space Reduction
400	N/A	(1)#3/0 AWG - 750 Kcmil or (2)#3/0 AWG 250 Kcmil Cu or Al	Deduct 0" of Unit Space
600	N/A	(2)#3/0 AWG - 750 Kcmil	Deduct 5" of Unit Space
800	N/A	(3)#3/0 AWG - 750 Kcmil Cu or Al	Deduct 10" of Unit Space
1200	N/A	(4)#3/0 AWG - 600 Kcmil Cu or Al	Deduct 10" of Unit Space
		(4)#3/0 AWG - 750 Kcmil Cu or Al	



# Panelboards

## Kits and Accessories

Selection

### P4 Enclosures

Description	Catalog number
P4 Type 1 32" W x 10" D x 60" H	PB60
P4 Type 1 32" W x 10" D x 75" H	PB75
P4 Type 1 32" W x 10" D x 90" H	PB90
P4 Type 3R/12 60" H	WP260
P4 Type 3R/12 75" H	WP275
P4 Type 3R/12 90" H	WP290

### P4 Trims

Description	Catalog number
P4 Std (4 piece trim) vented 60"	P460V
P4 Std (4 piece trim) vented 75"	P475V
P4 Std (4 piece trim) vented 90"	P490V
P4 VBS Std (4 Piece trim) vented 60"	P460VV
P4 VBS Std (4 Piece trim) vented 75"	P475VV
P4 VBS Std (4 Piece trim) vented 90"	P490VV
P4 Std (4 piece trim) unvented 60"	P460NV
P4 Std (4 piece trim) unvented 75"	P475NV
P4 Std (4 piece trim) unvented 90"	P490NV
P4 VBS Std (4 Piece trim) unvented 60"	P460NVV
P4 VBS Std (4 Piece trim) unvented 75"	P475NVV
P4 VBS Std (4 Piece trim) unvented 90"	P490NVV
P4 Std (4 piece trim) vented 60" with hinged gutter covers	P460VHG
P4 Std (4 piece trim) vented 75" with hinged gutter covers	P475VHG
P4 Std (4 piece trim) vented 90" with hinged gutter covers	P490VHG
P4 VBS Std (4 piece trim) vented 60" w/Hinged gutter covers	P460VVHG
P4 VBS Std (4 piece trim) vented 60" w/Hinged gutter covers	P475VVHG
P4 VBS Std (4 piece trim) vented 60" w/Hinged gutter covers	P490VVHG
P4 Std (4 piece trim) unvented 60" with hinged gutter covers	P460NVHG
P4 Std (4 piece trim) unvented 75" with hinged gutter covers	P475NVHG
P4 Std (4 piece trim) unvented 90" with hinged gutter covers	P490NVHG
P4 VBS Std (4 piece trim) unvented 60" w/Hinged gutter covers	P460NVVHG
P4 VBS Std (4 piece trim) unvented 60" w/Hinged gutter covers	P475NVVHG
P4 VBS Std (4 piece trim) unvented 60" w/Hinged gutter covers	P490NVVHG
P4 Std (1 PC Door) vented 60"	P460VD
P4 Std (1 PC Door) vented 75"	P475VD
P4 Std (1 PC Door) vented 90"	P490VD
P4 Std (1 PC Door) unvented 60"	P460NVD
P4 Std (1 PC Door) unvented 75"	P475NVD
P4 Std (1 PC Door) unvented 90"	P490NVD
P4 Std (1 PC Door-in-door) vented 60"	P460VDD
P4 Std (1 PC Door-in-door) vented 75"	P475VDD
P4 Std (1 PC Door-in-door) vented 90"	P490VDD
P4 Std (1 PC Door-in-door) unvented 60"	P460NVDD
P4 Std (1 PC Door-in-door) unvented 75"	P475NVDD
P4 Std (1 PC Door-in-door) unvented 90"	P490NVDD

### P4 Flush mounting kits

Description	Catalog number
Flush kit for P4 60" High	F60
Flush kit for P4 75" High	F75
Flush kit for P4 90" High	F90

# Panelboards

## Type P4 Panelboards

## Dimensions

PANELBOARDS 11

### Type 1 Box

Box is symmetrical

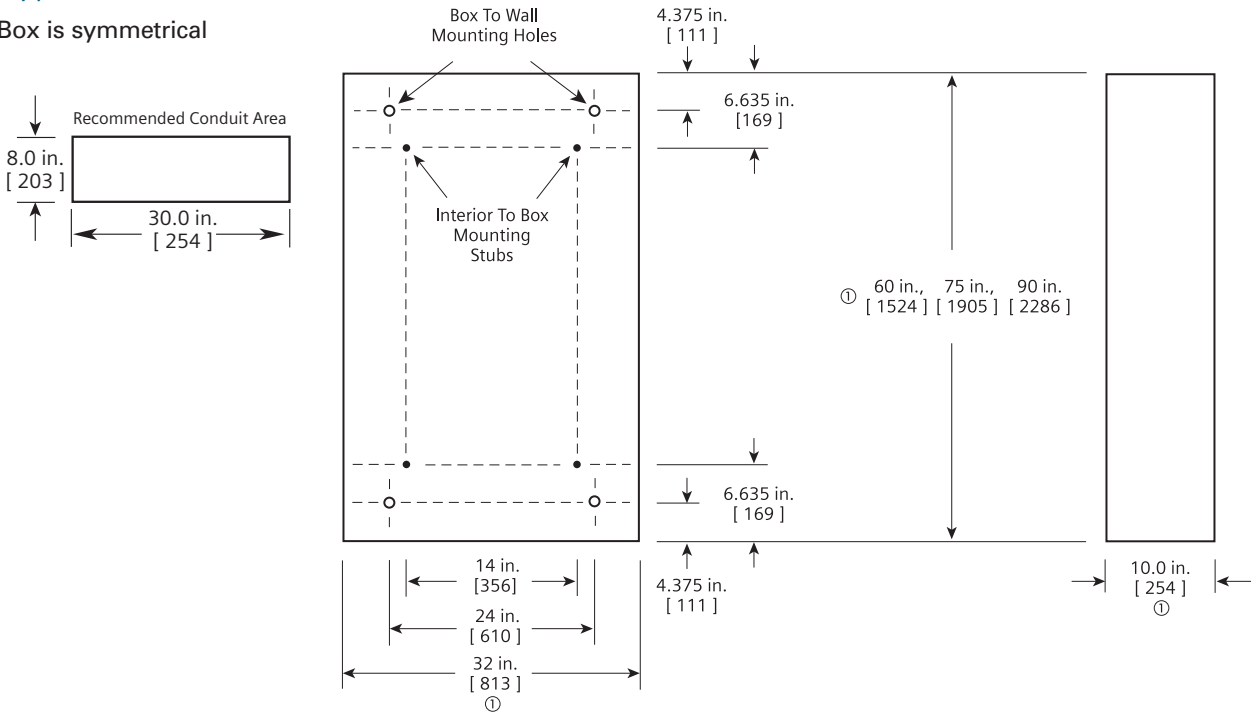

### Type 3R and 3R/12 Box

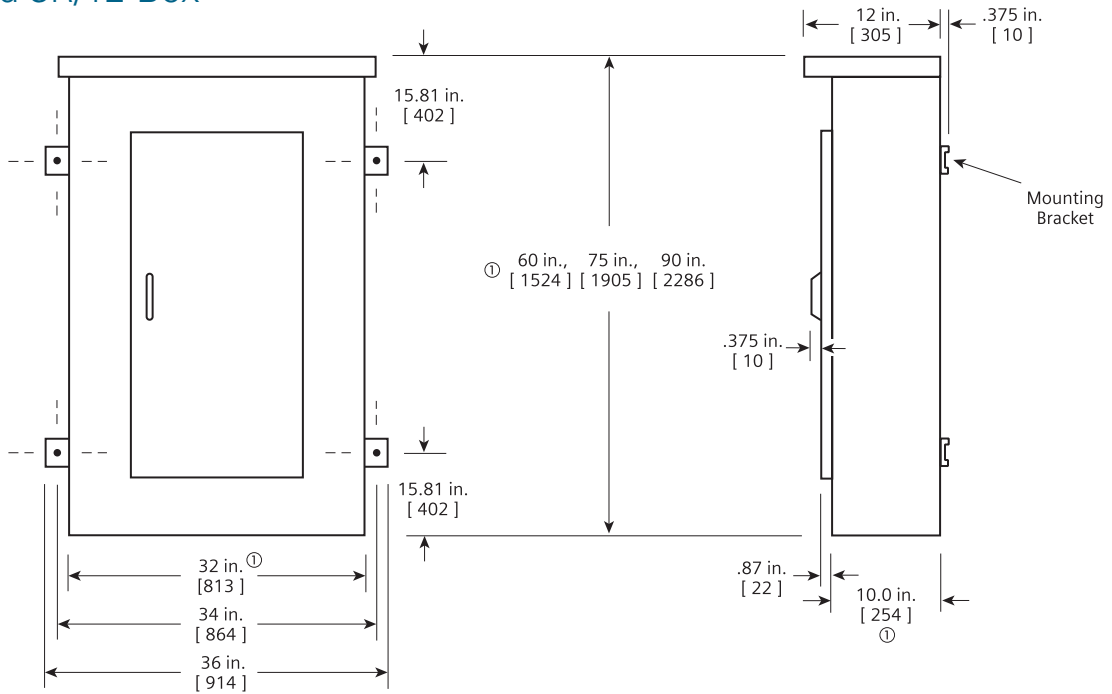

① Dimensions are interior of the box. Add 5/8" to width for absolute dimension. Add 1/8" to height for absolute dimension.  
**Dimensions shown in inches and millimeters [ ].**

# Panelboards

## Type P5 Panelboards

General

### Features

The P5 is the largest distribution panel in the Siemens' panel family. Even with a larger footprint, the P5 is still a space saver with its 38" width and 12.75" depth. The panel offers higher main ratings to fit applications that require larger branch devices.

This panel offers a wide array of factory assembled options and has the ability to mix breaker frames in unit space up to 1200 amps and fusible switches up to 1200 amps. Bussing options for the P5 vary from the standard temperature rated aluminum to temperature rated copper and 750 A/SI aluminum and 1000A/SI copper designs. All aluminum bussing in the P5 panel is tin-plated as a standard. Silver-plated is offered as the default for copper bus and tin as an option. Integrated time clocks, bus mounted contactors as mains or submains, split bus and subfeed lugs (up to 600 amps) are just a few of the options of this flexible panel.

The P5 panel configurations defined by the unit space allowed for a given amperage, main device and box height. The P5 panel starts with a 60" high box. All of the branch devices are unit space mounted. Breakers and switches can be mixed and matched to meet customer requirements.

#### Main Lug / Main Breaker / Main Switch

**Enclosure** – Standard Type 1 enclosure is 38" wide x 12.75" deep. X Box Height is determined by main device and unit space. See charts for box height.

**Voltage** – 600V AC max.  
250V DC max.

**Amperage** – 400-1200 amp main breaker, 400-1200 amp main lug only or 200-1200 amp main switch.

**Short Circuit Rating** – 200 Kaic max. symmetrical or equal to the lowest rated device installed unless a series rating is indicated. Panels with subfeed or feed-thru lugs without a main device, circuit breaker or fusible unit, are limited to a three-cycle rating. The three-cycle rating for the P5 panel is limited to 42 Kaic. Note that the main device may be mounted remote from the panel.

**Bussing** – The P5 panel has more options to meet market requirements. The standard bussing is temperature rated aluminum. The rating is per the requirements of UL 67 – the standard for panelboards. All aluminum bussing is tin-plated. Optional bussing for the P5 panel is: 750 A/SI aluminum, temperature rated copper, and 1000 A/SI copper. The copper bus option for this panel is tin-plated.

#### Weight – Approximate

Total panelboard weight when filled with a normal quantity of breakers and accessories is about 10 lbs. (1 kg) per inch (54g per mm) of box height.

#### Main Lugs <sup>①</sup>

Ampere Rating	Connectors Suitable for Copper or Aluminum
400	(1) 250-500Kcmil
600	(2) #3/0-500Kcmil
800	(3) #3/0 AWG-500 Kcmil
1000	(4) #3/0 AWG-500 Kcmil
1200	(4) #3/0 AWB-500 Kcmil

<sup>①</sup> Alternate lugs for 750 kcmil cable are available, but result in significant loss of branch unit mounting space. Consult Siemens.

#### Gauge Steel of Boxes Fronts, Surface and Flush

Dimensions in inches (mm)		Gauge Steel	
Width	Height	Box	Fronts
38" (965)	60 - 75 - 90 (1524,1905, 2286)	#16 <sup>①</sup>	#14 (1 piece trim) #14 (4 piece trim)
	60 - 75 - 90 (1524,1905, 2286)	#14	#12 (1 piece & door in door) #10 (1 piece & door in door)
	60 - 75 - 90 (1524,1905, 2286)	#14	#16 (4 piece, top and bottom over) #10 (4 piece, side/ gutter cover)

<sup>①</sup> 16 gauge side panels, 12 gauge back support, 14 gauge back panels.

## Enclosure Selection <sup>①</sup>

Enclosure Dimension in Inches (mm)			Available Unit Space in Inches (mm)						
H	W	D	Main Lug Only		Main Breaker		Main VB Switch		Main HCP Switch
Type 1 or 3R/12	Type 1	Type 3R/12	400 - 1200A	400-800A	1200A	200A	400A-600A	400-1200A	
60 (1524)	38 (965)	12.75 (324)	14.25 (362)	30 (762)	21.25 (540)	20 (508)	20 (508)	-	13.75 (349)
75 (1905)	38 (965)	12.75 (324)	14.25 (362)	45 (1143)	36.25 (921)	35 (889)	40 (1016)	25 (889)	28.75 (730)
90 (2286)	38 (965)	12.75 (324)	14.25 (362)	60 (1524)	51.25 (1302)	50 (1270)	55 (1397)	40 (1270)	43.75 (1111)

## Main Breaker Unit Space Dimensions

Ampere Rating	Breaker Family	Breaker Type	Dimensions in inches (mm)	
			A	B
400	Sentron	JXD6, JD6, HJXD6, HJD6, HHJXD6, HHJD6	13.425 (265)	13.125 (333)
	VL <sup>Ⓢ</sup>	NJ, HJ, LJ	15.500 (318)	
	Sentron	SJD6, SHJD6	13.425 (265)	
		CJD6, SCJD6	11.250 (210)	
600	Sentron	LXD6, LD6, HLXD6, LD6, HHLXD6, HHLD6	13.425 (265)	
	VL <sup>Ⓢ</sup>	NL, HL, LL	14.250 (286)	
	Sentron	SLD6, SHLD6	13.425 (265)	
		CLD6, SCLD6	11.250 (210)	
800	VL	NM, HM, LM	13.425 (265)	
	Sentron	MXD6, MD6, HMXD6, HMD6, CMD6, SMD6, SHMD6, SCMD6	13.00 (330) 10.42 (265)	
		VL	NN, HN, LN	
1200	Sentron	NXD6, ND6, HNXD6, HND6, CND6, SND6, SHMD6, SCND6	13.00 (330) 13.00 (330)	

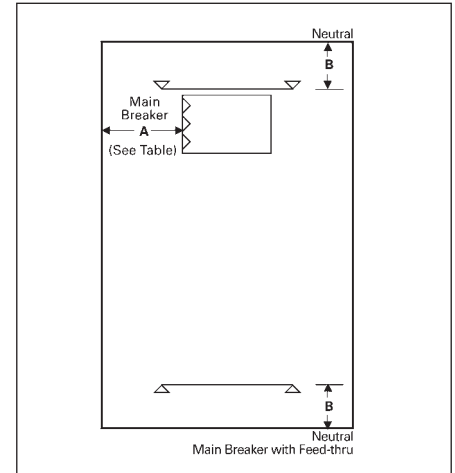

Main Breaker Wire Bending Space Dimensions & Main Switch

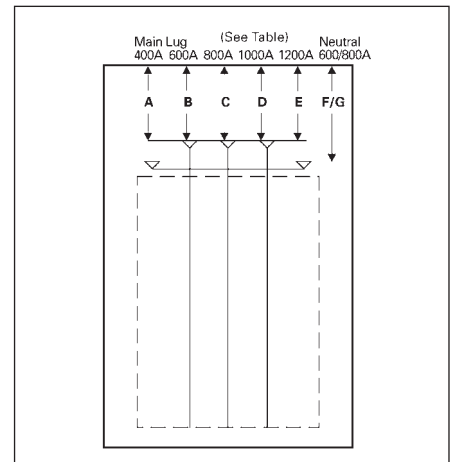

Main Lugs Only Wire Bending Space

## Main Switch

Maximum Ampere Rating	A	B
400A/600A VB	9.30 (236)	13.125 (333)
800A/1200A HCP	10.30 (262)	
200A VB	13.425 (265)	

## Main Switch Connectors

Ampere Rating	Connectors suitable for Copper or Aluminum
400	(1) #3/0 AWG-500 kcmil (2) #3/0 AWG-250 kcmil
600	(2) #3/0 AWG-500 kcmil
800	(3) #3/0 AWG-500 kcmil
1200	(4) #3/0 AWG-500 kcmil

## Main Lugs Only Wire Bending Space

Lugs	Dimensions in inches (mm)					
	Main Lug					Neutral
	400A A	600A B	800A C	1000A D	1200A E	800A G
Standard	16.500 (419)	16.750 (425)	15.969 (406)	15.969 (406)	15.969 (406)	13.125 (333)
Oversize	16.500 (419)	21.750 (552)	25.969 (660)	25.969 (660)	25.969 (660)	23.125 (587)
Crimp	19.187 (487)	18.250 (464)	18.687 (475)	18.250 (464)	18.250 (464)	15.937 (405)
Standard with Subfeed	16.750 (425)	15.969 (406)	—	—	—	13.125 (333)
Standard with Feed-thru	16.500 (419)	16.750 (425)	—	—	—	13.125 (333)

<sup>①</sup> Standard trim is for space without door. Surface flush one piece trim is available for 32" (813mm) wide circuit breaker panel.

<sup>Ⓢ</sup> Available with solid state (electronic) trip units only.

# Panelboards

## Type P5

### Shown with Standard Mains, Top Fed and Surface Trim

Catalog number is for aluminum main bus. For optional copper main bus change "A" in position 11 to "E" (silver-plated copper bus).

Panels are top feed, surface mounted. For bottom feed, change "T" in position 12 to "B". For flush mounting, change "S" in position 13 to "F".

Replace fifth and sixth position in panelboard catalog number, with alternate main breaker code. Use price adders from main breaker section table. Horizontally mounted.

### Main Lugs Only — shown with aluminum bus, top fed, and surface trims.

Maximum Panel Ampere Rating	Unit Space (inches)	208Y/120V	240/120V	120/240V or 250 Vdc Max
		3-Phase, 4-Wire Catalog Number	3-Phase, 4-Wire Catalog Number	1-Phase, 3-Wire Catalog Number
800 <sup>Ⓜ</sup>	30	P5C60ML800ATS	P5B60ML800ATS	P5A60ML800ATS
	45	P5C75ML800ATS	P5B75ML800ATS	P5A75ML800ATS
	60	P5C90ML800ATS	P5B90ML800ATS	P5A90ML800ATS
1000	30	P5C60ML101ATS	P5B60ML101ATS	P5A60ML101ATS
	45	P5C75ML101ATS	P5B75ML101ATS	P5A75ML101ATS
	60	P5C90ML101ATS	P5B90ML101ATS	P5A90ML101ATS
1200	30	P5C60ML120ATS	P5B60ML120ATS	P5A60ML120ATS
	45	P5C75ML120ATS	P5B75ML120ATS	P5A75ML120ATS
	60	P5C90ML120ATS	P5B90ML120ATS	P5A90ML120ATS
Maximum Panel Ampere Rating	Unit Space (inches)	240	480Y/277V	480V <sup>Ⓜ</sup>
		3-Phase, 3-Wire Catalog Number	3-Phase, 4-Wire Catalog Number	1-Phase, 3-Wire Catalog Number
800 <sup>Ⓜ</sup>	30	P5D60ML800ATS	P5E60ML800ATS	P5F60ML800ATS
	45	P5D75ML800ATS	P5E75ML800ATS	P5F75ML800ATS
	60	P5D90ML800ATS	P5E90ML800ATS	P5F90ML800ATS
1000	30	P5D60ML101ATS	P5E60ML101ATS	P5F60ML101ATS
	45	P5D75ML101ATS	P5E75ML101ATS	P5F75ML101ATS
	60	P5D90ML101ATS	P5E90ML101ATS	P5F90ML101ATS
1200	30	P5D60ML120ATS	P5E60ML120ATS	P5F60ML120ATS
	45	P5D75ML120ATS	P5E75ML120ATS	P5F75ML120ATS
	60	P5D90ML120ATS	P5E90ML120ATS	P5F90ML120ATS

### Main Circuit Breaker — shown with aluminum bus, top fed, and surface trims.

Maximum Panel Ampere Rating	Unit Space (inches)	208Y/120V	240/120V	120/240V or 250 Vdc Max
		3-Phase, 4-Wire Catalog Number	3-Phase, 4-Wire Catalog Number	1-Phase, 3-Wire Catalog Number
800 <sup>Ⓜ</sup>	21.25	P5C60M1800ATS	P5B60M1800ATS	P5A60M1800ATS
	36.25	P5C75M1800ATS	P5B75M1800ATS	P5A75M1800ATS
	51.25	P5C90M1800ATS	P5B90M1800ATS	P5A90M1800ATS
1200	20	P5C60N1120ATS	P5B60N1120ATS	P5A60N1120ATS
	35	P5C75N1120ATS	P5B75N1120ATS	P5A75N1120ATS
	50	P5C90N1120ATS	P5B90N1120ATS	P5A90N1120ATS
Maximum Panel Ampere Rating	Unit Space (inches)	240	480Y/277V	480V <sup>Ⓜ</sup>
		3-Phase, 4-Wire Catalog Number	3-Phase, 4-Wire Catalog Number	1-Phase, 3-Wire Catalog Number
800 <sup>Ⓜ</sup>	21.25	P5D60M1800ATS	P5E60M1800ATS	P5F60M1800ATS
	36.25	P5D75M1800ATS	P5E75M1800ATS	P5F75M1800ATS
	51.25	P5D90M1800ATS	P5E90M1800ATS	P5F90M1800ATS
1200	20	P5D60N1120ATS	P5E60N1120ATS	P5F60N1120ATS
	35	P5D75N1120ATS	P5E75N1120ATS	P5F75N1120ATS
	50	P5D90N1120ATS	P5E90N1120ATS	P5F90N1120ATS

For inches / millimeters conversion, see Application Data section.

<sup>Ⓜ</sup> For 600V, change "F" in position 3 to "G". Price only branch breakers with 600V ratings.

<sup>Ⓜ</sup> Alternate main breaker requires additional 1.25" unit space.

# Panelboards

Power and Distribution

Selection

PANELBOARDS 11

## Main Fusible Switch (fuses not included)

Maximum Panel Ampere Rating	Unit Space (inches)	208Y/120V	240/120V	120/240V	240V	480Y/277V	480V <sup>①</sup>
		3-Phase, 4-Wire Catalog Number	3-Phase, 4-Wire Catalog Number	1-Phase, 3-Wire Catalog Number	3-Phase, 3-Wire Catalog Number	3-Phase, 4-Wire Catalog Number	3-Phase, 3-Wire Catalog Number
400	25	P5C75MS400ATS	P5B75MS400ATS	P5A75MS400ATS	P5D75MS400ATS	P5E75MS400ATS	P5F75MS400ATS
	40	P5C90MS400ATS	P5B90MS400ATS	P5A90MS400ATS	P5D90MS400ATS	P5E90MS400ATS	P5F90MS400ATS
600	25	P5C75MS600ATS	P5B75MS600ATS	P5A75MS600ATS	P5D75MS600ATS	P5E75MS600ATS	P5F75MS600ATS
	40	P5C90MS600ATS	P5B90MS600ATS	P5A90MS600ATS	P5D90MS600ATS	P5E90MS600ATS	P5F90MS600ATS
800 <sup>④</sup>	28.75	P5C75MS800ATS	P5B75MS800ATS	P5A75MS800ATS	P5D75MS800ATS	P5E75MS800ATS	P5F75MS800ATS
	43.75	P5C90MS800ATS	P5B90MS800ATS	P5A90MS800ATS	P5D90MS800ATS	P5E90MS800ATS	P5F90MS800ATS
1200 <sup>④</sup>	28.75	P5C75MS120ATS	P5B75MS120ATS	P5A75MS120ATS	P5D75MS120ATS	P5E75MS120ATS	P5F75MS120ATS
	43.75	P5C90MS120ATS	P5B90MS120ATS	P5A90MS120ATS	P5D90MS120ATS	P5E90MS120ATS	P5F90MS120ATS

## Alternate Main Breaker Selection<sup>②</sup>

Breaker Frame Rating	Trip Type	Breaker Family	Frame Type	Alternate Main Breaker Code <sup>③</sup>	Trip Amperage	Unit Space Requirements in Inches	Maximum Interruption Rating (KAIC) Volts AC					
							240	480	600			
400	Thermal Magnetic	Sentron	JXD6	JX	200, 225, 250, 300, 350, 400	8.75	65,000	35,000	25,000			
			JD6	J6	200, 225, 250, 300, 350, 400	8.75	65,000	35,000	25,000			
			HJXD6	H5	200, 225, 250, 300, 350, 400	8.75	100,000	65,000	35,000			
			HJD6	H6	200, 225, 250, 300, 350, 400	8.75	100,000	65,000	35,000			
			HHJXD6	H9	200, 225, 250, 300, 350, 400	8.75	200,000	100,000	50,000			
			HHJD6	6H	200, 225, 250, 300, 350, 400	8.75	200,000	100,000	50,000			
	Electronic (Solid state)	VL	Sentron	CJD6	CJ	200, 225, 250, 300, 350, 400	8.75	200,000	150,000	100,000		
				NJ	J1	250, 400	6.25	65,000	35,000	25,000		
				HJ	J7	250, 400	6.25	100,000	65,000	25,000		
		Sentron	Sentron	LJ	J3	250, 400	6.25	200,000	100,000	25,000		
				SJD6	SJ	200, 300, 400	8.75	65,000	35,000	25,000		
				SHJD6	SX	200, 300, 400	8.75	100,000	65,000	35,000		
600	Thermal Magnetic	Sentron	SCJD6	SC	200, 300, 400	8.75	200,000	150,000	100,000			
			LXD6	LX	450, 500, 600	8.75	65,000	35,000	25,000			
			LD6	L6	250, 300, 350, 400, 450, 500, 600	8.75	65,000	35,000	25,000			
			HLXD6	HO	250, 300, 350, 400, 450, 500, 600	8.75	100,000	65,000	35,000			
			HLD6	HL	250, 300, 350, 400, 450, 500, 600	8.75	100,000	65,000	35,000			
			HHLXD6	XH	250, 300, 350, 400, 450, 500, 600	8.75	200,000	100,000	50,000			
			HHLD6	HH	250, 300, 350, 400, 450, 500, 600	8.75	200,000	100,000	50,000			
			CLD6	CL	250, 300, 350, 400, 450, 500, 600	8.75	200,000	150,000	100,000			
			Electronic (Solid state)	VL	Sentron	NL	L7	400, 600	6.25	65,000	35,000	25,000
	HL	L2				400, 600	6.25	100,000	65,000	25,000		
	LL	SL				400, 600	6.25	200,000	100,000	25,000		
	Sentron	Sentron		SLD6	L6	300, 400, 500, 600	8.75	65,000	35,000	25,000		
				SHLD6	S2	300, 400, 500, 600	8.75	100,000	65,000	35,000		
				SCLD6	SI	300, 400, 500, 600	8.75	200,000	150,000	100,000		
				NM	M1	600, 700, 800	8.75	65,000	35,000	25,000		
				HM	M2	600, 700, 800	8.75	100,000	65,000	35,000		
				LM	M3	600, 700, 800	8.75	200,000	100,000	50,000		
	800	Thermal Magnetic	Sentron	LMXD6	LM	500, 600, 700, 800	8.75	65,000	50,000	25,000		
LMD6				L1	500, 600, 700, 800	8.75	65,000	50,000	25,000			
HLMXD6				HK	500, 600, 700, 800	8.75	100,000	65,000	50,000			
HLMD6				HJ	500, 600, 700, 800	8.75	100,000	65,000	50,000			
MXD6				MX	500, 600, 700, 800	10.00	65,000	50,000	25,000			
MD6				MD	500, 600, 700, 800	10.00	65,000	50,000	25,000			
HMXD6				HR	500, 600, 700, 800	10.00	100,000	65,000	50,000			
HMD6				HM	500, 600, 700, 800	10.00	100,000	65,000	50,000			
CMD6				CM	500, 600, 700, 800	10.00	200,000	100,000	65,000			
Electronic (Solid state)				VL	Sentron	NM	M1	600, 800	8.75	65,000	35,000	25,000
						HM	M2	600, 800	8.75	100,000	65,000	35,000
						LM	M3	600, 800	8.75	200,000	100,000	50,000
		Sentron	Sentron	SMD6	SM	600, 700, 800	10.00	65,000	50,000	25,000		
				SHMD6	S5	600, 700, 800	10.00	100,000	65,000	50,000		
				SCMD6	SO	600, 700, 800	10.00	200,000	100,000	65,000		
1200		Thermal Magnetic	Sentron	NN	N1	800, 900, 1000, 1200	10.00	65,000	35,000	25,000		
				HN	N2	800, 900, 1000, 1200	10.00	100,000	65,000	35,000		
				LN	N3	800, 900, 1000, 1200	10.00	200,000	100,000	65,000		
	NXD6			NX	900, 1000, 1200	10.00	65,000	50,000	25,000			
	ND6			ND	900, 1000, 1200	10.00	65,000	50,000	25,000			
	HNXD6			HT	900, 1000, 1200	10.00	100,000	65,000	50,000			
	Electronic (Solid state)	VL	Sentron	HND6	HN	900, 1000, 1200	10.00	100,000	65,000	50,000		
				CND6	Cn	900, 1000, 1200	10.00	200,000	100,000	65,000		
				NN	N1	800, 1000, 1200	10.00	65,000	35,000	25,000		
		Sentron	Sentron	HN	N2	800, 1000, 1200	10.00	100,000	65,000	35,000		
				LN	N3	800, 1000, 1200	10.00	200,000	100,000	65,000		
				SND6	SN	800, 1000, 1200	10.00	65,000	50,000	25,000		
Sentron	Sentron	SHND6	AD	800, 1000, 1200	10.00	100,000	65,000	50,000				
		SCND6	SR	800, 1000, 1200	10.00	200,000	100,000	65,000				

For inches / millimeters conversion, see Application Data section.

① For 600V, change "F" in position 3 to "G". Price only branch breakers with 600V ratings.  
② For ground fault, see page 11-75.

③ Replace "MS" in catalog number with code letter.  
④ 800 and 1200 ampere switches have "L" class fuse provisions (Type HCP).

# Panelboards

Power and Distribution

Selection

## Type P5

### Branch Circuit Breakers<sup>①</sup>

Breaker Frame Rating	Trip Type	Breaker Family	Frame Type	Poles	Trip Amperage	Unit Space Requirements in Inches		Maximum Interruption Rating (KAIC) Volts AC						
						Single	Twin	120	240	480Y/277	480	600Y/347	600	
100	Thermal Magnetic	General Application	BL <sup>⑥</sup>	1, 2, 3	15-60, 70, 80, 90, 100	—	3.75 <sup>②③</sup>	10,000	10,000	—	—	—	—	
			BLR	2	15, 20, 30, 40, 50, 60, 70, 80, 90, 100	—	3.75 <sup>②③</sup>	10,000	10,000	—	—	—	—	
			BLH <sup>⑥</sup>	1, 2, 3	15-60, 70, 80, 90, 100	—	3.75 <sup>②③</sup>	22,000	22,000	—	—	—	—	
			HBL <sup>⑥</sup>	1, 2, 3	15-60, 70, 80, 90, 100	—	3.75 <sup>②③</sup>	65,000	65,000	—	—	—	—	
			BQD <sup>⑥</sup>	1, 2, 3	15-50, 60, 70, 80, 90, 100	—	3.75 <sup>②③</sup>	65,000	65,000	14,000	—	—	—	
			BQD6 <sup>⑥⑦</sup>	1, 2, 3	15-50, 60, 70	—	3.75 <sup>②③</sup>	65,000	65,000	—	—	10,000	—	
	Special Application	Ground Fault Circuit Interrupter	General Application	BL-HID <sup>⑥</sup>	1, 2	15, 20, 30	—	3.75 <sup>②③</sup>	10,000	10,000	—	—	—	—
				BL-BG <sup>⑥</sup>	2, 3	15, 20, 30	—	3.75 <sup>②③</sup>	10,000	10,000	—	—	—	—
				BLE-GFCI <sup>⑥</sup>	1, 2	15, 20, 30, 40, 50, 60	—	3.75 <sup>②</sup>	10,000	10,000	—	—	—	—
				BLEH-GFCI <sup>⑥</sup>	1, 2	15, 20, 30, 40, 50, 60	—	3.75 <sup>②</sup>	10,000	10,000	—	—	—	—
				BLF-GFCI <sup>⑥</sup>	1, 2	15, 20, 30, 40, 50, 60	—	3.75 <sup>②</sup>	10,000	10,000	—	—	—	—
				BLHF-GFCI <sup>⑥</sup>	1, 2	15, 20, 30, 40, 50, 60	—	3.75 <sup>②</sup>	10,000	10,000	—	—	—	—
				BAF-AFCI <sup>⑥</sup>	1, 2	15, 20	—	3.75 <sup>②</sup>	10,000	10,000	—	—	—	—
				BAFH-AFCI <sup>⑥</sup>	1, 2	15, 20	—	3.75 <sup>②</sup>	10,000	10,000	—	—	—	—
Arc Fault Circuit Interrupter	General Application	General Application	BAFC-AFCI <sup>⑥</sup>	1, 2	15, 20	—	3.75 <sup>②</sup>	10,000	10,000	—	—	—		
			BAFCH-AFCI <sup>⑥</sup>	1, 2	15, 20	—	3.75 <sup>②</sup>	10,000	10,000	—	—	—		
125	Thermal Magnetic	General Application	NGB <sup>⑥</sup>	1, 2, 3	15-60, 70, 80, 90, 100, 110, 125	—	3.75 <sup>②③</sup>	—	100,000	25,000	—	14,000	—	
			HGB <sup>⑥</sup>	1, 2, 3	15-60, 70, 80, 90, 100, 110, 125	—	3.75 <sup>②③</sup>	—	100,000	35,000	—	14,000	—	
			LGB <sup>⑥</sup>	1, 2, 3	15-60, 70, 80, 90, 100, 110, 125	—	3.75 <sup>②③</sup>	—	100,000	65,000	—	14,000	—	
			NGB2 <sup>⑥</sup>	1, 2, 3	15-60, 70, 80, 90, 100, 110, 125	—	3.75 <sup>②③</sup>	—	100,000	—	25,000	14,000	—	
			HGB2 <sup>⑥</sup>	1, 2, 3	15-60, 70, 80, 90, 100, 110, 125	—	3.75 <sup>②③</sup>	—	100,000	—	35,000	22,000	—	
			LGB2 <sup>⑥</sup>	1, 2, 3	15-60, 70, 80, 90, 100, 110, 125	—	3.75 <sup>②③</sup>	—	100,000	—	65,000	25,000	—	
			ED4	1, 2, 3	15-50, 60, 70, 80, 90, 100, 110, 125	—	3.75 <sup>②③</sup>	—	65,000	—	18,000	—	—	
			HED4 <sup>④⑤</sup>	1, 2, 3	15-50, 60, 70, 80, 90, 100, 110, 125	—	3.75 <sup>②③</sup>	—	100,000	—	42,000	—	—	
			HHED6	3	15-50	—	3.75 <sup>②③</sup>	—	100,000	—	65,000	—	18,000	
			CED6 <sup>⑥</sup>	2, 3	20-50, 60, 70, 80, 90, 100, 110, 125	—	3.75 <sup>②③</sup>	—	200,000	—	200,000	—	100,000	
150	Electronic (Solid state)	VL	ND	3	60, 100, 150	—	5.00	—	65,000	—	35,000	—	18,000	
			HD	3	60, 100, 150	—	5.00	—	100,000	—	65,000	—	20,000	
			LD	3	60, 100, 150	—	5.00	—	200,000	—	100,000	—	25,000	
225	Thermal Magnetic	General Application	QR2	2, 3	100, 110, 125, 150, 175, 200, 225	—	5.00	—	10,000	—	—	—	—	
			QRH2	2, 3	100, 110, 125, 150, 175, 200, 225	—	5.00	—	25,000	—	—	—	—	
			HQR2	2, 3	100, 110, 125, 150, 175, 200, 225	—	5.00	—	65,000	—	—	—	—	
			HQR2H	2, 3	100, 110, 125, 150, 175, 200, 225	—	5.00	—	100,000	—	—	—	—	
250	Thermal Magnetic	Sentron	FXD6, FD6	2, 3	70-110, 125, 150, 175, 200, 225, 250	5.00	5.00	—	65,000	—	35,000	—	22,000	
			HFXD6, HFD6	2, 3	70-110, 125, 150, 175, 200, 225, 250	5.00	5.00	—	100,000	—	65,000	—	25,000	
			HHFXD6, HHFD6	2, 3	70-110, 125, 150, 175, 200, 225, 250	5.00	5.00	—	200,000	—	100,000	—	25,000	
			CFD6	3	70-110, 125, 150, 175, 200, 225, 250	—	5.00	—	200,000	—	200,000	—	100,000	
	Electronic (Solid state)	VL	NF	3	100, 150, 250	—	5.00	—	65,000	—	35,000	—	18,000	
			HF	3	100, 150, 250	—	5.00	—	100,000	—	65,000	—	20,000	
			LF	3	100, 150, 250	—	5.00	—	200,000	—	100,000	—	25,000	
400	Thermal Magnetic	Sentron	JXD6, JD6	2, 3	200, 225, 250, 300, 350, 400	8.75	8.75	—	65,000	—	35,000	—	25,000	
			HJXD6, HJD6	2, 3	200, 225, 250, 300, 350, 400	8.75	8.75	—	100,000	—	65,000	—	35,000	
			HHJXD6, HHJD6	2, 3	200, 225, 250, 300, 350, 400	8.75	8.75	—	200,000	—	100,000	—	50,000	
			CJD6	3	200, 225, 250, 300, 350, 400	8.75	—	—	200,000	—	150,000	—	100,000	
	Electronic (Solid state)	VL	NJ	3	250, 400	6.25	6.25	—	65,000	—	35,000	—	25,000	
			HJ	3	250, 400	6.25	6.25	—	100,000	—	65,000	—	25,000	
			LJ	3	250, 400	6.25	6.25	—	200,000	—	100,000	—	25,000	
		Sentron	SJD6	3	200, 300, 400	8.75	—	—	65,000	—	35,000	—	25,000	
			SHJD6	3	200, 300, 400	8.75	—	—	100,000	—	65,000	—	35,000	
SCJD6	3	200, 300, 400	8.75	—	—	200,000	—	150,000	—	100,000				

For inches / millimeters conversion, see Application Data section.

① Includes housing frame plate with blank cover plate. Provision price includes all necessary mounting hardware, less circuit breaker, and includes housing

frame cover plate with breaker handle opening.  
 ② 1 to 6 poles may be mounted in 3.75" of unit space.  
 ③ Accessories such as shunt trips on three pole breakers require 6.25" of unit space.  
 ④ HED4 1-pole 15-30A = 65,000 IR  
 35-100A = 25,000 IR

⑤ HED4 3-Pole = 42,000 IR  
 ⑥ Special 7.5" 2P design to fit G breakers in 7.5" of unit space available in BL family, GB and BQD.  
 ⑦ BQD6 is not UL Listed. Only for CUL and CSA panels.  
 ⑧ D6/CED6 2-pole limited amps available (20-50A)

11 PANELBOARDS

## Type P5

### Branch Circuit Breakers<sup>①</sup> (cont.)

Breaker Frame Rating	Trip Type	Breaker Family	Frame Type	Poles	Trip Amperage	Unit Space Requirements in Inches		Maximum Interruption Rating (KAIC) Volts AC							
						Single	Twin	120	240	480Y/277	480	600Y/347	600		
600	Thermal Magnetic	Sentron	LXD6	2, 3	450, 500, 600	8.75	—	—	65,000	—	35,000	—	25,000		
			LD6	2, 3	250, 300, 350, 400, 450, 500, 600	8.75	—	—	65,000	—	35,000	—	25,000		
			HXXD6, HXXLD6	2, 3	250, 300, 350, 400, 450, 500, 600	8.75	—	—	100,000	—	65,000	—	35,000		
			HXXLD6, HXXLD6	2, 3	250, 300, 350, 400, 450, 500, 600	8.75	—	—	200,000	—	100,000	—	50,000		
			CLD6	3	250, 300, 350, 400, 450, 500, 600	8.75	—	—	200,000	—	150,000	—	100,000		
	Electronic (Solid state)	VL	HL	3	400, 600	6.25	—	—	65,000	—	35,000	—	25,000		
			HL	3	400, 600	6.25	—	—	100,000	—	65,000	—	25,000		
			LL	3	400, 600	6.25	—	—	200,000	—	100,000	—	25,000		
		Sentron	SLD6	3	300, 400, 500, 600	8.75	—	—	65,000	—	35,000	—	25,000		
			SHLD6	3	300, 400, 500, 600	8.75	—	—	100,000	—	65,000	—	35,000		
			SCLD6	3	300, 400, 500, 600	8.75	—	—	200,000	—	150,000	—	100,000		
		800	Thermal Magnetic	VL	NM	2, 3	600, 700, 800	8.75	—	—	65,000	—	35,000	—	25,000
					HM	2, 3	600, 700, 800	8.75	—	—	100,000	—	65,000	—	35,000
					LM	2, 3	600, 700, 800	8.75	—	—	200,000	—	100,000	—	50,000
Sentron	MXD6			2, 3	600, 700, 800	10.00	—	—	65,000	—	50,000	—	25,000		
	MD6			2, 3	500, 600, 700, 800	10.00	—	—	65,000	—	50,000	—	25,000		
	HXXD6			2, 3	600, 700, 800	10.00	—	—	100,000	—	65,000	—	50,000		
	HXXD6			2, 3	500, 600, 700, 800	10.00	—	—	100,000	—	65,000	—	50,000		
	CMD6			3	600, 700, 800	10.00	—	—	200,000	—	100,000	—	65,000		
	CMD6			3	600, 700, 800	10.00	—	—	200,000	—	100,000	—	65,000		
Electronic (Solid state)	VL		NM	3	600, 800	8.75	—	—	65,000	—	35,000	—	25,000		
			HM	3	600, 800	8.75	—	—	100,000	—	65,000	—	35,000		
			LM	3	600, 800	8.75	—	—	200,000	—	100,000	—	50,000		
	Sentron		SMD6	3	600, 700, 800	10.00	—	—	65,000	—	50,000	—	25,000		
			SHMD6	3	600, 700, 800	10.00	—	—	100,000	—	65,000	—	50,000		
1200	Thermal Magnetic	VL	NN	2, 3	800, 900, 1000, 1200	10.00	—	—	65,000	—	35,000	—	25,000		
			HN	2, 3	800, 900, 1000, 1200	10.00	—	—	100,000	—	65,000	—	35,000		
			LN	2, 3	800, 900, 1000, 1200	10.00	—	—	200,000	—	100,000	—	65,000		
		Sentron	NXD6	2, 3	900, 1000, 1200	10.00	—	—	65,000	—	50,000	—	25,000		
			ND6	2, 3	800, 900, 1000, 1200	10.00	—	—	65,000	—	50,000	—	25,000		
			HXXD6	2, 3	900, 1000, 1200	10.00	—	—	100,000	—	65,000	—	50,000		
			HXXD6	2, 3	800, 900, 1000, 1200	10.00	—	—	100,000	—	65,000	—	50,000		
			CND6	2, 3	900, 1000, 1200	10.00	—	—	200,000	—	100,000	—	65,000		
			CND6	2, 3	900, 1000, 1200	10.00	—	—	200,000	—	100,000	—	65,000		
	Electronic (Solid state)	VL	NN	3	800, 1000, 1200	10.00	—	—	65,000	—	35,000	—	25,000		
			HN	3	800, 1000, 1200	10.00	—	—	100,000	—	65,000	—	35,000		
			LN	3	800, 1000, 1200	10.00	—	—	200,000	—	100,000	—	65,000		
		Sentron	SND6	3	800, 1000, 1200	10.00	—	—	65,000	—	50,000	—	25,000		
			SHND6	3	800, 1000, 1200	10.00	—	—	100,000	—	65,000	—	50,000		
SCND6	3	800, 1000, 1200	10.00	—	—	200,000	—	100,000	—	65,000					

For inches / millimeters conversion, see Application Data section.

① Includes housing frame plate with blank cover plate. Provision price includes all necessary mounting hardware, less circuit breaker, and includes housing frame cover plate with breaker handle opening.



# Panelboards

Power and Distribution

Selection/Dimensions

Ampere Rating	Mounting Height (inches)
<b>240V — Twin Mounted</b>	
<b>NEC Fuse Clips<sup>①</sup></b>	
30-30	2½ <sup>②</sup>
30-30	5
30-60	5
60-60	5
60-100	7½
100-100	7½
200-200	10

Ampere Rating	Mounting Height (inches)
<b>240V — Single Mounted</b>	
<b>NEC Fuse Clips<sup>①</sup></b>	
30	7½
60	7½
100	7½
200	10
200	7½
400	15
600	15
800 (HCP)	16¼
1200 (HCP)	16¼

Ampere Rating	Mounting Height (inches)
<b>600V — Twin Mounted</b>	
<b>NEC Fuse Clips<sup>①</sup></b>	
30-30	7½
30-60	7½
60-60	7½
60-100	7½
100-100	7½
200-200	10

Ampere Rating	Mounting Height (inches)
<b>600V — Single Mounted</b>	
<b>NEC Fuse Clips<sup>①</sup></b>	
100	7½
200	10
400	15
400 (HCP)	15
600	15
600	15
800 <sup>③</sup> (HCP)	16¼
1200 <sup>③</sup> (HCP)	16¼

## Branch Breaker Side Gutter Inches (mm)

Reference Letter	Panel Width 38 Inches Dimensions in inches (mm)
A	14.00 (356)
B	13.98 (355)
C	11.62 (295)
D	10.00 (254)
E	7.61 (193)
F	8.75 (222)
G	8.25 (210)
H	10.90 (276)
I	10.90 (276)
J	11.76 (299)
K	7.92 (201)
L	8.00 (203)
M	13.42 (341)
N	12.00 (305)
O	15.50 (393)
P	14.25 (362)
Q	13.42 (341)
R	13.42 (341)
S	10.00 (254)
T	8.00 (203)
U	10.50 (267)
V	10.50 (267)
W	9.30 (236)
X	10.30 (262)
Y	9.30 (236)
Z	10.30 (262)

← A →	BL, BLH, HBL, BQD	BL, BLH, HBL, BQD	← A →
← B →	NGB, HGB, LGB NGB2, HGB2, LGB2	NGB, HGB, LGB NGB2, HGB2, LGB2	← B →
← D →	ED4, ED6, HED4, HHED6	ED4, ED6, HED4, HHED6	← D →
← E →	CED6	CED6	← E →
← F →	QR2, QRH2, HQR2, HQR2H	QR2, QRH2, HQR2, HQR2H	← F →
← G →	FD6, FXD6, HFD6, HHFD6	FD6, FXD6, HFD6, HHFD6	← G →
← H →	ND, HD, LD	ND, HD, LD	← H →
← I →	NF, HF, LF	NF, HF, LF	← I →
← J →	CFD		← J →
← K →	JD6, JXD6, HJD6, HHJD6	JD6, JXD6, HJD6, HHJD6	← K →
← L →	NJ, HJ, LJ	NJ, HJ, LJ	← L →
← M →	SJD6, SHJD6, LD6, LXD6, HLD6, HHLD6, SLD6, SHLD6		← M →
← N →	CJD6, SCJD6, CLD6, SCLD6		← N →
← O →	NJ, HJ, LJ		← O →
← P →	NL, HL, LL		← P →
← Q →	NM, HM, LM		← Q →
← R →	NN, HN, LN		← R →
← S →	VB 30 A	VB 30 A	← S →
← T →	VB 30 - 60A	VB 30 - 60A	← T →
← U →	VB 60 -100A	VB 60 -100A	← U →
← V →	VB 200A	VB 200A	← V →
← W →	VB 100A Single		← W →
← X →	VB 200A Single		← X →
← Y →	VB 400 - 600A Single		← Y →
← Z →	HCP 400 - 1200A Single		← Z →

For inches / millimeters conversion, see Application Data section.

① For Class J, R or T fuse clip prices, refer to page 11-75.

② NEC fuse clips only.

③ 800 and 1200 ampere switches have class "L" fuse provisions. (Type HCP).

# Panelboards

Power and Distribution

Selection/Dimensions

 11  
 PANELBOARDS

## Types P5 and SPP/FPP, F2 (12 3/4" deep)

### Connecting Strap Kits<sup>①②③</sup> Circuit Breaker

For use with P5, Sentron Deep or Type S5 Power Panels					
Max Amp Rating	Breaker Family	Breaker Type	Catalog Number	Unit Height (inches)	Mounting
100	General	BL, BQD	SBLBD	3.75	Twin
125	General	NGB, HGB, LGB	SNBD	3.75	Twin
	General	NGB2, HGB2, LGB2	SGB2D	3.75	Twin
	General	ED	SE6D	3.75	Twin
	General	CED	SCED	3.75	Twin
150	VL	DG	SDGD	5.00	Twin
225	General	QR	SQRD <sup>②</sup>	5.00	Twin
250	Sentron	FD	SF6D	5.00	Twin
	VL	FG	SFGD	5.00	Twin
	Sentron	CFD	SCFD	5.00	Single
400	Sentron	JD	SJ1D	8.75	Single
	Sentron	JD	SJ2D	8.75	Twin
	Sentron	SJD	SSJ1D	8.75	Single
	VL	JG	SJG1D	6.25	Single
	VL	JG	SJG2D	6.25	Twin
	Sentron	CJD	SCJD	8.75	Single
	Sentron	SJD	SCJD	8.75	Single
600	Sentron	LD	SL6D	8.75	Single
	Sentron	SLD	SSL6D	8.75	Single
	VL	LG	SLGD	6.25	Single
	Sentron	CLD	SCLD	8.75	Single
	Sentron	SCLD	SSCLD	8.75	Single
800	VL	MG	MG1D	8.75	Single
	Sentron	LMD	SLM1D	8.75	Single
	Sentron	MD	SMND	10.00	Single
	Sentron	SMD	SSMND	10.00	Single
1200	VL	NG	NG1D	10.00	Single
	Sentron	ND	SMND	10.00	Single
	Sentron	SND	SSMND	10.00	Single

### Service Entrance Barriers

Field installable Barriers to meet UL 67 service entrance requirements	
Breaker Type	Catalog Number
(S)JD, (S)LD, MG	SEBP4V1
CJD, CLD	SEBP4V2
JG, LG	SEBP4V3
(S)MD, (S)ND without shield	SEBP5V1
(S)MD, (S)ND with shield	SEBP5V2
Vacu-Break Switches	SEBP5V3
HCP Switches	SEBP5V4

For inches / millimeters conversion, see Application Data section.

① Normal stock item.

② Includes cover plate and mounting hardware, less circuit breaker.

③ Also fits Types FCI, FCII, SB1 and SB2 switchboards.

④ 800–1200 amp units are HCP switch.

⑤ Suitable to replace QF3 in P1 thru P5 Panelboards and Switchboards

⑥ To replace a QJ with a QR only a new cover is needed up to 225A

⑦ Although QR is rated 250A, it is limited to 225A in panelboard.

### Connecting Strap Kits<sup>③</sup> Fusible

For use with P5, Sentron FPP Deep or Type F2 power panels		
Ampere Rating	Unit Height (inches)	12.75" Deep Box Catalog Number
30–30	2.5	F602D
30–30	5, 7.5	F657D
30–60	5, 7.5	F657D
60–60	5, 7.5	F657D
60–100	5, 7.5	F657D
100–100	5, 7.5	F657D
100	7.5	F657D
200	7.5	F657D
200	10	F671D
200–200	10	F672D
400–600	15	F6150D
800–1200 <sup>④</sup>	16.25	F6162D

### Blank Plates Circuit Breaker and Vacu-Break<sup>①</sup>

For use with P5, Sentron SPP and Type S5 power panels	
Height (inches)	Catalog Number
1.25	6FPB01
2.5	6FPB02
3.75	6FPB03
5.0	6FPB05
10.0	6FPB10

### Filler Plates

For use with P5, Sentron SPP and Type S5 power panels	
Breaker Type	Filler Plate Catalog Number
BL, BLH, HBL, BQD, ED4, ED6, HED4, HHED6, NGB, HGB, LGB, NGB2, HGB2, LGB2,	DFFP1 <sup>⑤</sup>
NEB, HEB	EBF1

### Cover Plates

For use with P5, Sentron SPP and Type S5 power panels	
Breaker Type	Catalog Number
QR	SQRC <sup>⑥</sup>

Note: When a front filler plate is not completely filled with breakers, the openings in the unused space must be closed with filler plates selected from this table.

# Panelboards

## Modifications and Additions

## Selection

### Type P5 Panelboards

Devices Mounted on Gutter Cover Includes Device, Mounting – Wired or Unwired

Description
One piece front with door
(Depth increases to 14.25")
Hinged Gutter Covers 4 pc front
Toggle Switch — SPST or 3-way
15A, 277V maximum
Pilot Light — General Purpose
Neon or Incandescent
Pushbutton

### Feed-Thru Lugs

Ampere Rating	Unit Space (inches)
400	10
600	10
800	17.5
1200	17.5

### Grounding of Panelboards

Ground Bars except for brazed to box are shipped with the panel interior factory mounted.

- Non-Insulated Equipment Ground Bar – Standard
- Copper Non-Insulated Ground Bar
- Al Insulated Equipment Ground Bar
- Cu Insulated Equipment Ground Bar
- Ground Bar Brazed to Box

### Fuse Clip Provisions (Add to 250 Volts or 600 Volts Unit Prices Per Switch)

Amp Rating	Class J	Class R	Class T
30	•	•	N/A
60	•	•	N/A
100	•	•	•
200 <sup>①</sup>	•	•	•
400	•	•	•
600	•	•	•

• Indicates available

### Ground Fault on Main Breaker

Description	Amp Rating
Conventional Ground Fault <sup>②</sup> Includes:	
Ground Fault Relay, Ground Sensor, CPT and Shunt Trip	800-1200
Test and Monitor Panel <sup>③</sup>	
Ground Fault add to Sensitrip III breaker price (takes 5" of unit space)	800-1200

### Time Clocks<sup>④</sup>

Sangamo, Tork or Paragon time clock can be supplied, mounted in panel-board cabinet. For required increase in enclosure dimension, consult local sales office.

Description
Time clock (1- or 2-Pole, Single or Double Throw Contacts; 3-Pole Single Throw)
277V Maximum with Plain Dial
Optional: Astronomical Dial An Omitting Device Reserve Power or Carryover
Space and Mounting Provisions Only

### Circuit Breaker Accessories Handle Blocking Device Blocks handle in either the "ON" or "OFF" position.

### Padlocking Device – Padlocks in "OFF" position.

### Main Bus

Standard main bus and ground bus are tin-plated aluminum. For copper main bus, neutral bus and ground bus, add from the table for each panel.

### Lugs – For Main Lug Only Panels

Standard main lugs and neutral lugs are tin-plated aluminum, UL listed for use with aluminum/copper cables. Copper only lugs are an option.

Ampere Rating
400 - 1200

### Shunt Trip on Main and Branches<sup>⑤</sup>

Description
BL, BQD, NGB, HGB, LGB, NGB2, HGB2, LGB2 (branch only)
QR2, QRH2, HQR2, HQR2H ED4, HED4, HHED6, CED6 (branch only)
All others to 1200A

### 100% Rated Main Circuit Breakers

Ampere Rating	Breaker Type
400	JXD6H, HJXD6H
	NJY, HJY, LJY
600	LXD6H, HLXD6H
600 <sup>⑥</sup>	NMY, HMY, LMY
800 <sup>⑦</sup>	NNY, HNY, LNY
	MXD6H, HMXD6U, SMD6, SHMD6, SND6, SHND6, NXD6H, HNXD6H
1200	NNY, HNY, LNY
	NXD6H, HNXDH,

<sup>①</sup> For use on main lug, main breaker or main switch panels without subfeed breakers.

<sup>②</sup> Available in 90" high enclosure only. Unit space is 42½" with Test and Monitor Panel; 45" without Test Monitor Panel.

<sup>③</sup> Not available on Sensitrip III.

<sup>④</sup> For required unit space, consult local sales office.

<sup>⑤</sup> Shunt Trip on 100A frame breakers increases mounting height to 6.25" for twin mounting.

<sup>⑥</sup> The 600A, 100% rated breaker application requires the use of an 800A frame breaker.

<sup>⑦</sup> The 800A, 100% rated breaker application requires the use of a 1200A frame breaker.

# Panelboards

Embedded Micro Metering Module™

Selection

## SEM3 System configured in Panelboards

The Siemens SEM3 system can be configured for factory installation in branch circuit monitoring applications using the Siemens COMPAS configuration tool. This option can lower the installation time of the system for the installer while providing a factory warranted solution.

The SEM3 system can be factory installed in unit space in type P2, P4, & P5 Siemens panel boards. Please note P1 and P3 configurations are not available at this time and the amount of unit space needed varies depending upon the application. Please note that lead time adders will apply and may vary depending upon the configuration of the system.

## SEM3 for use in Siemens Panelboards

### Available in a NEMA 1, 3R, or 12 rated enclosure



#### Controller

SEM3 controller is mounted in unit space opposite of the feed location specified in COMPAS (i.e., bottom mount for top feed) and will require 3" of unit space. Each controller will be powered by direct tap connection to the panel section bus. Each controller can monitor up to 45 circuits. Applications that require monitoring more than 45 circuits will require additional controllers.



#### Current Transformers (CTs)

Five sizes of CTs are available for use in the P5 panel: 50, 125, 250, 400, 500, 600, 800 & 1200 amp. All CTs are pre-mounted to a support bracket that attaches to the base rail of the interior of the panel board. Each bracket supports a maximum of 3 CTs and is designed for the breaker selected (brackets are not interchangeable between breaker frames). Each CT will be attached to a data module that is placed in the meter racks.



#### Meter Racks

Each meter rack requires 3" of unit space. All meter racks will be installed next to the SEM3 controller in unit space. The COMPAS configuration tool will select the appropriate meter rack configuration according to the user's application and will use the 21 space meter rack as a default option where possible. Only one meter rack (regardless of number of positions) can be installed in 3" of unit space.

**NOTE:** Monitoring of 45 circuits will require 9" of unit space: two 21 position racks and one 3 position rack

#### Other Considerations

**Configuration:** Data modules from CTs monitoring a circuit breaker must be mounted adjacent to one another in the meter rack. Any field changes to the factory configuration must take this into account.

**Start-up & Commissioning:** Siemens can provide these services. Contact your local SIEMENS PDS Power Solutions Business Developer for more details.

**Billing Services for sub billing applications:** Billing services are available. Contact your local SIEMENS PDS Power Solutions Business Developer for more details.

# Panelboards

Embedded Micro Metering Module™

Selection

## P5 Devices Enclosure sizes

PANELBOARDS

### Example P5 Panel with SEM3 Type 1 Enclosure P5 = (38" or 46" Wide x 10" Deep)

Enclosure heights are in 15" increments from 60" thru 90".  
Enclosure heights: 60", 75", 90" (there are optional depths also)

The COMPAS configuration tool can provide actual dimensions based on the configuration. Example below is largest standard P4 enclosure for factory assembled panel - unit space is in 3.75" increments - up to 6 circuits can occupy each 3.75" of unit space.

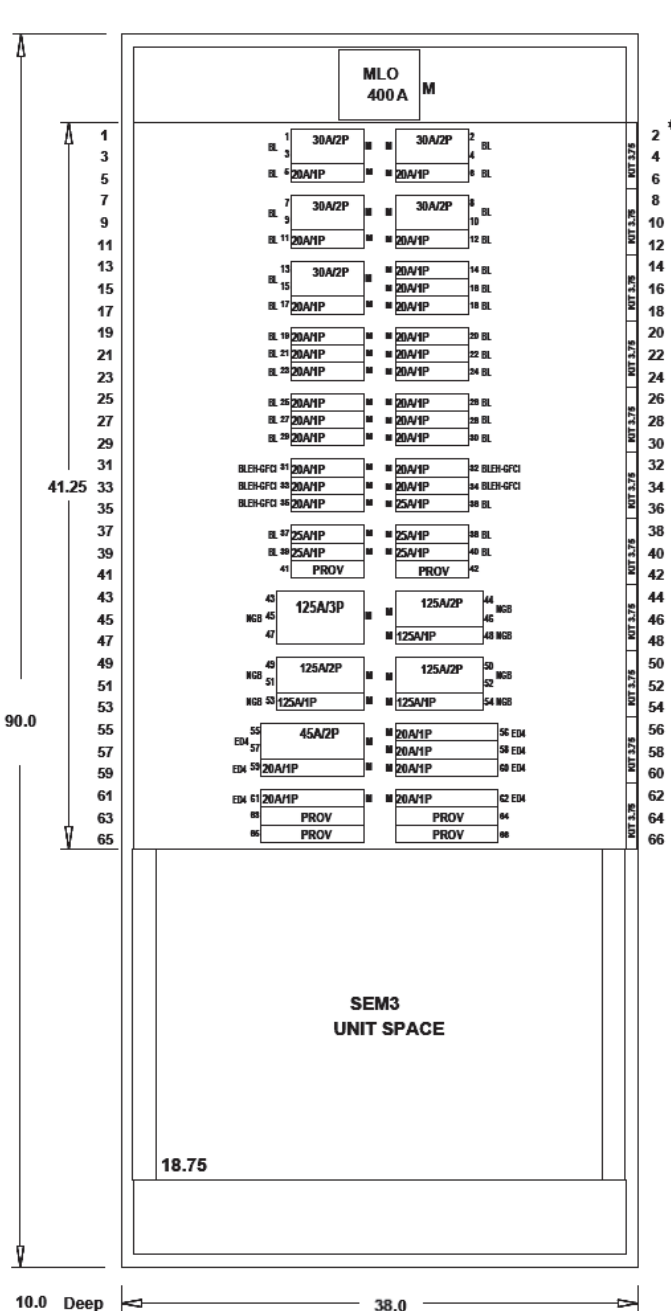

← 38" std. width for P5 →

**Main Breaker / Main Lug space varies based on selected options**

**Unit space varies based on selected options**

**Note:** All circuits do not have to be monitored by SEM3 - user can select any circuits in this space to be monitored.

Based on smallest branch breakers and a 3-phase main being monitored. There is a maximum of 63 circuits that can be monitored with the configuration shown. Some selections of main breakers and other subfeed options could limit this further.

In this situation there is 37.5" of unit space available - so 60 branch circuits could be monitored. If monitoring the main three additional circuits could be monitored with a total of 63 circuits.

This requires two controllers and three 21 position racks using 18.75" of unit space. - see below -

**SEM3 space varies by number of circuits monitored - this uses unit space.**

- == > 7.5" of space for up to 21 circuits monitored one controller and one 21-pos rack
- == > 11.25" of space for up to 42 circuits monitored one controller and two 21-pos racks
- == > 15" of space for up to 45 circuits monitored one controller and two 21-pos racks plus one 3-pos rack
- == > 18.75" of space for up to 63 circuits monitored two controllers and three 21-pos racks

**Note:** If subfeed space is needed - it will take away from available unit space.

# Panelboards

Modifications and Additions

Selection

PANELBOARDS 11

## Type P5 Panelboards

### Vacu-Break Fusible Switches

#### For Branch Circuit Use with AC Combination Full Voltage Starters <sup>①</sup>

Amp Rating	Horsepower Ratings				Mounting Height in Inches (mm)				Min. Section Width Inches (mm)
	240V AC		480V AC		240V AC		480V AC		
	With NEC Fuse	With Dual-Element Fuse	With NEC Fuse	With Dual-Element Fuse	Twin	Single	Twin	Single	
30-30	3	7.5	—	—	2.50 <sup>Ⓢ</sup> (64)	—	—	—	32 (813)
30-30	3	7.5	5	10	5.00 (127)	—	7.50 (191)	—	32 (813)
30-60	3-7.5	7.5-15	5-15	25	5.00 (127)	—	7.50 (191)	—	32 (813)
60-60	7.5	15	15	25	5.00 (127)	—	7.50 (191)	—	32 (813)
60-100	7.5-15	15-30	15-25	25-50	7.50 (191)	—	7.50 (191)	—	32 (813)
100-100	15	30	25	50	7.50 (191)	—	7.50 (191)	—	32 (813)
100	—	—	25	50	—	—	—	7.50 (191)	32 (813)
200	25	50	50	100	—	10.00 (254)	—	10.00 (254)	32 (813)
200-200	—	50	—	100	10.00 (254)	—	10.00 (254)	—	32 (813)
400	50	100	100	—	—	15.00 (381)	—	15.00 (381)	38 (965)
600	75	100	—	—	—	15.00 (381)	—	15.00 (381)	38 (965)

### Connector Modifications

#### Compression Lugs

Style	Amp Rating	Breaker Type	Compression Connectors	Available Unit Space Reduction
MLO	800	N/A	All compression lugs	Deduct 5.0" Unit Space
	1000	N/A	All compression lugs	Deduct 5.0" Unit Space
	1200	N/A	All compression lugs	Deduct 5.0" Unit Space
Main Breaker	800	MD6, HMD6, CMD6, SMD6, SHMD6, SCMD6	(3)#2/0 AWG - 500 Kcmil CU or Al	0
	1200	ND6, HND6, CND6, SND6, SHND6, SCND6	(4)#250 - 500 Kcmil Cu or Al	0

#### Alternate Lugs

Style	Amp Rating	Breaker Type	Compression Connectors	Available Unit Space Reduction
MLO	800	N/A	(3)#3/0 AWG - 750 Kcmil Cu or Al	Deduct 10" Unit Space
	1000	N/A	(4)#3/0 - 600 Kcmil Cu or Al (4)#3/0 AWG - 750 Kcmil Cu or Al	Deduct 10" Unit Space
	1200	N/A	(4)#3/0 AWG - 600 Kcmil Cu or Al (4)#3/0 AWG - 750 Kcmil CU or Al	Deduct 10" Unit Space

① 100,000 kA at 480V with Class J or Class RK5 fuses.

Ⓢ The 2.50 inch (64mm) high unit is suitable for NEC Class H and K5 fuses only. Class R rejection type fuse holders are not available.

# Panelboards

## Kits and Accessories

Selection

### Type P5 Panelboards

#### Enclosures

Description	Catalog number
P5 Type 1 36" W x 12.75" D x 60" H	<b>PB860</b>
P5 Type 1 36" W x 12.75" D x 75" H	<b>PB875</b>
P5 Type 1 36" W x 12.75" D x 90" H	<b>PB890</b>
P5 Type 1 36" W x 14.75" D x 60" H	<b>PBD860</b> <sup>①</sup>
P5 Type 1 36" W x 14.75" D x 75" H	<b>PBD875</b> <sup>①</sup>
P5 Type 1 36" W x 14.75" D x 90" H	<b>PBD890</b> <sup>①</sup>
P5 Type 3R/12 60" H	<b>WP860</b>
P5 Type 3R/12 75" H	<b>WP875</b>
P5 Type 3R/12 90" H	<b>WP890</b>

#### Trims

Description	Catalog number
P5 Std (4 piece trim) vented 60"	<b>P560V</b>
P5 Std (4 piece trim) vented 75"	<b>P575V</b>
P5 Std (4 piece trim) vented 90"	<b>P590V</b>
P5 Std (4 piece trim) unvented 60"	<b>P560NV</b> <sup>②</sup>
P5 Std (4 piece trim) unvented 75"	<b>P575NV</b> <sup>②</sup>
P5 Std (4 piece trim) unvented 90"	<b>P575NV</b> <sup>②</sup>
P5 Std (4 piece trim) vented 60" with hinged gutter covers	<b>P560VHG</b>
P5 Std (4 piece trim) vented 75" with hinged gutter covers	<b>P575VHG</b>
P5 Std (4 piece trim) vented 90" with hinged gutter covers	<b>P590VHG</b>
P5 Std (4 piece trim) unvented 60" with hinged gutter covers	<b>P560NVHG</b>
P5 Std (4 piece trim) unvented 75" with hinged gutter covers	<b>P575NVHG</b>
P5 Std (4 piece trim) unvented 90" with hinged gutter covers	<b>P590NVHG</b>
P5 Std (1 PC Door) vented 60"	<b>P560VD</b> <sup>③</sup>
P5 Std (1 PC Door) vented 75"	<b>P575VD</b> <sup>③</sup>
P5 Std (1 PC Door) vented 90"	<b>P590VD</b> <sup>③</sup>
P5 Std (1 PC Door) unvented 60"	<b>P560NVD</b> <sup>③</sup>
P5 Std (1 PC Door) unvented 75"	<b>P575NVD</b> <sup>③</sup>
P5 Std (1 PC Door) unvented 90"	<b>P590NVD</b> <sup>③</sup>
P5 Std (1 PC Door-in-door) vented 60"	<b>P560VDD</b> <sup>③</sup>
P5 Std (1 PC Door-in-door) vented 75"	<b>P575VDD</b> <sup>③</sup>
P5 Std (1 PC Door-in-door) vented 90"	<b>P590VDD</b> <sup>③</sup>
P5 Std (1 PC Door-in-door) unvented 60"	<b>P560NVDD</b> <sup>③</sup>
P5 Std (1 PC Door-in-door) unvented 75"	<b>P575NVDD</b> <sup>③</sup>
P5 Std (1 PC Door-in-door) unvented 90"	<b>P590NVDD</b> <sup>③</sup>

#### Flush mounting kits

Description	Catalog number
Flush kit to P5 60" High	<b>F860</b>
Flush kit to P5 75" High	<b>F875</b>
Flush kit to P5 90" High	<b>F890</b>

<sup>①</sup> Required with door over breaker handles.

<sup>③</sup> Requires 14.5" deep box.

<sup>②</sup> Unvented trims require amps per square inch bussing.

# Panelboards

Type P5 Panelboards

Dimensions

PANELBOARDS  
11

## Type 1 Box

Box is symmetrical

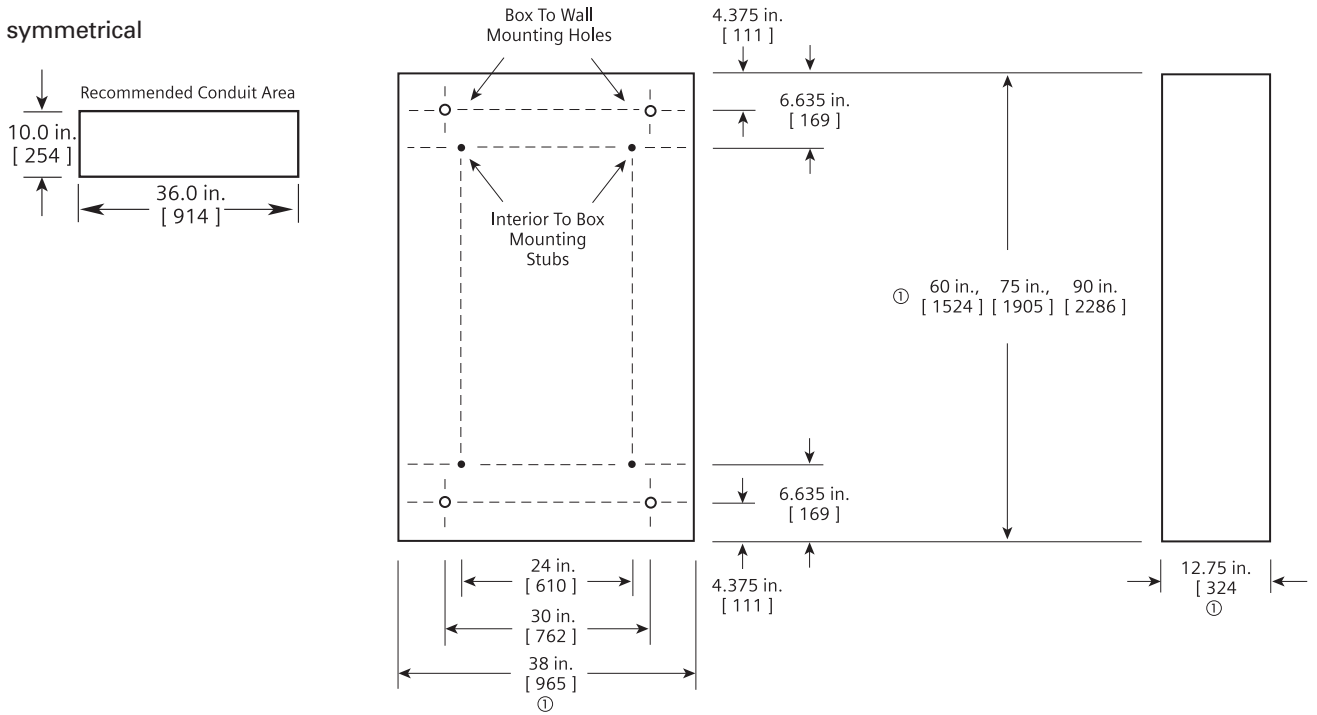

## Type 3R and 3R/12 Box

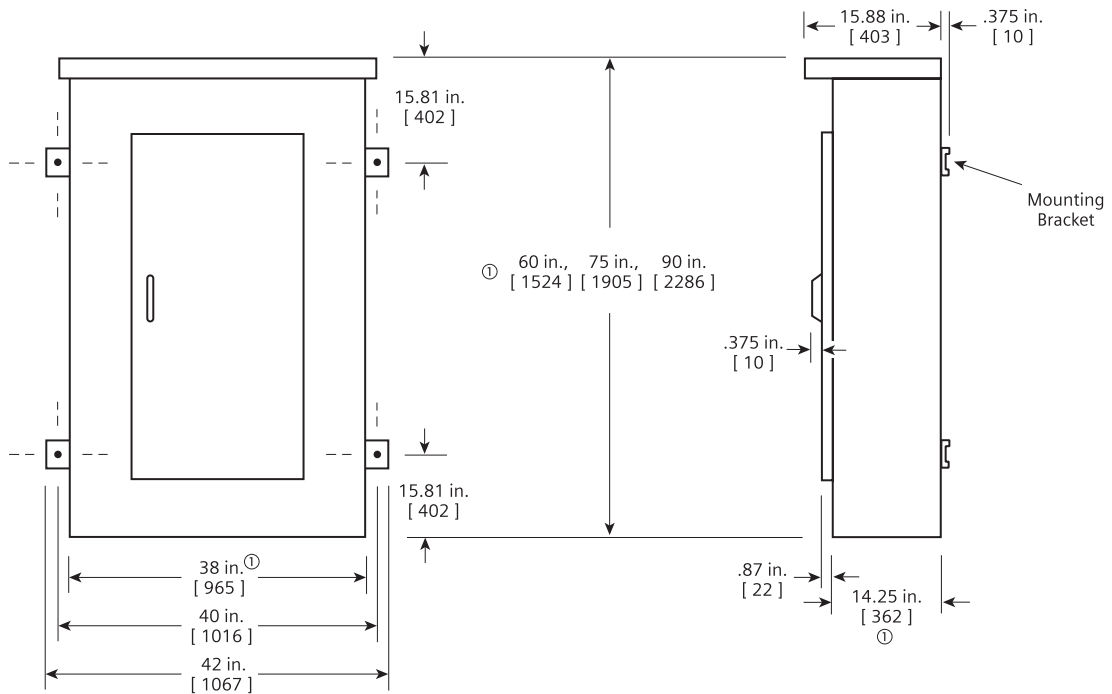

ⓄDimensions are interior of the box. Add 5/8" to width for absolute dimension. Add 1/8" to height for absolute dimension.  
Dimensions shown in inches and millimeters [ ].



# Panelboards

## Type C1

**240 Volts AC Maximum**  
**250 Ampere Mains**  
**250 Ampere Maximum Branch**  
**UL Short Circuit Rating —**  
**200,000 IR Maximum**

**Branch Breaker Symmetrical**  
**Interrupting Rating**

**Based on Underwriters' Test Procedure**

## Type C2

**480Y/277 Volts AC Maximum**  
**250 Ampere Mains**  
**250 Ampere Maximum Branch**  
**UL Short Circuit Rating —**  
**100,000 IR Maximum**

Meets NEC wire bending requirement, section 312-6.

### Panelboards

Listed by Underwriter's Laboratories, Inc., under "Panelboards" File #E2269.

Meets Federal Specification W-C375B/Gen.

### Service

240 Volts Maximum. 1-Phase, 3-Wire, or 3-Phase, 4-Wire.

### Panelboards Fronts and Doors

Standard panelboards are furnished with trim with a flush door lock. All are factory assembled for ease of installation. Fronts are fabricated from code gauge steel and finished ANSI-61.

### Main Breakers C1

BL, BLH and HBL frame breakers are mounted horizontally. All other frames are mounted vertically.

### Main Breakers C2

BQD frame breakers are mounted horizontally. All other frames are mounted vertically.

### Boxes

C1 — 7 $\frac{5}{8}$ " wide, 5 $\frac{3}{4}$ " deep.  
 C2 — 8 $\frac{1}{2}$ " wide, 5 $\frac{3}{4}$ " deep.

### Branch Breaker Side Gutters

Type	Circuit Breaker	Side Gutter (inches)
C1	BL, BLH, HBL	3.505
C2	BQD	3.5

### Weight—Approximate

Total panelboard weight when filled with a normal quantity of breakers and accessories is:

\*About 3 lbs. per inch of box height.

### Gauge Steel Boxes

Type	Width	Height	Gauge Steel
C1	7 $\frac{5}{8}$ "	48", 73", 85"	#14
C2	8 $\frac{1}{2}$ "	48", 73", 85"	#14

### Fronts

C1	7 $\frac{5}{8}$ "	48", 73", 85"*	#14
C2	8 $\frac{1}{2}$ "	48", 73", 85"*	#14

\*Note: Feed thru lugs and subfeed breaker not available for this height.

### Main Breaker Connectors

Ampere Rating	Connectors suitable for Cu or Al
100	(1) #14-1/0 AWG
125	(1) #4-1/0 AWG
225	(1) #6 AWG-300 kcmil
250	(1) #4 AWG-350 kcmil Al (1) #6 AWG-350 kcmil Cu

### Main Lugs

125	(1) #6 AWG-350 kcmil
250	(1) #6 AWG-350 kcmil

For inches / millimeters conversion, see Application Data section.

① Connector ranges indicated do not apply to all main breaker types. Refer to molded case circuit breaker standard pressure wire connectors in the breaker section of this catalog for the wire ranges for a specific breaker frame.

# Panelboards

Circuit Breaker / Column Type

Selection

 11  
 PANELBOARDS

## Main Lugs Only C1 240 Volts Maximum

Maximum Panel Ampere Rating	Maximum 1-Pole Circuits	Box Height (inches)	208Y/120V	120/240V
			3-Phase, 4-Wire Catalog Number	1-Phase, 3-Wire Catalog Number
125	18	48	C1C18ML125CTS	C1A18ML125CTS
	30	73	C1C30ML125CTS	C1A30ML125CTS
	42	85	C1C42ML125CTS	C1A42ML125CTS
250	18	48	C1C18ML250CTS	C1A18ML250CTS
	30	73	C1C30ML250CTS	C1A30ML250CTS
	42	85	C1C42ML250CTS	C1A42ML250CTS

## Main Circuit Breaker<sup>①②</sup> C1 240 Volts Maximum

Maximum Panel Ampere Rating	Maximum 1-Pole Circuits	Box Height (inches)	208Y/120V	120/240V
			3-Phase, 4-Wire Catalog Number	1-Phase, 3-Wire Catalog Number
100	18	48	C1C18BL100CTS	C1A18BL100CTS
	30	73	C1C30BL100CTS	C1A30BL100CTS
	42	85	C1C42BL100CTS	C1A42BL100CTS
125	18	48	C1C18E4125CTS	C1A18E4125CTS
	30	73	C1C30E4125CTS	C1A30E4125CTS
	42	85	C1C42E4125CTS	C1A42E4125CTS
225	18	48	C1C18QR225CTS	C1A18QR225CTS
	30	73	C1C30QR225CTS	C1A30QR225CTS
	42	85	C1C42QR225CTS	C1A42QR225CTS
250	18	48	C1C18FX250CTS	C1A18FX250CTS
	30	73	C1C30FX250CTS	C1A30FX250CTS
	42	85	C1C42FX250CTS	C1A42FX250CTS

## Main Lugs Only C2 480Y/277 Volts Maximum

Maximum Panel Ampere Rating	Maximum 1-Pole Circuits	Box Height (inches)	480Y/277V
			3-Phase, 4-Wire Catalog Number
125	18	48	C2E18ML125CTS
	30	73	C2E30ML125CTS
	42	85	C2E42ML125CTS
250	18	48	C2E18ML250CTS
	30	73	C2E30ML250CTS
	42	85	C2E42ML250CTS

## Main Circuit Breaker<sup>①②</sup> C2 480Y/277 Volts Maximum

Maximum Panel Ampere Rating	Maximum 1-Pole Circuits	Box Height (inches)	480Y/277V
			3-Phase, 4-Wire Catalog Number
100	18	48	C2E18BD100CTS
	30	73	C2E30BD100CTS
	42	85	C2E42BD100CTS
125	18	48	C2E18E4125CTS
	30	73	C2E30E4125CTS
	42	85	C2E42E4125CTS
225	18	48	C2E18FX225CTS
	30	73	C2E30FX225CTS
	42	85	C2E42FX225CTS
250	18	48	C2E18FX250CTS
	30	73	C2E30FX250CTS
	42	85	C2E42FX250CTS

## Alternate Main Breaker Selection<sup>①②</sup> C1

Ampere Rating	Breaker Type	Maximum Interrupting Rating (KA)	Catalog Number	Available Trip Values
100	BL	10	BL	50, 60, 70, 80, 90, 100
	BLH	22	LH	50, 60, 70, 80, 90, 100
	HBL	65	HL	50, 60, 70, 80, 90, 100
125	ED4	65	E4	50, 60, 70, 80, 90, 100, 110, 125
	HED4	100	H4	50, 60, 70, 80, 90, 100, 110, 125
	HHED6	100	HA	50 (3-pole only)
225	QR2	10	QR	100, 110, 125, 150, 175, 200, 225
225	FXD6	65	FX	70, 80, 90, 100, 110, 125, 150, 175, 200, 225
	HFD6 <sup>②</sup>	100	HF	70, 80, 90, 100, 110, 125, 150, 175, 200, 225
250	FXD6	65	FX	250
	HFD6 <sup>②</sup>	100	HF	250

For inches / millimeters conversion, see Application Data section.

① BL, BLH, HBL and BQD are horizontally mounted. All others vertically mounted.

② Interchangeable trip breakers such as FD6 and HFD6 cannot be back fed. Must be top feed only.

# Panelboards

Circuit Breaker / Column Type

Selection

## Branch Breaker Selection C1

Breaker Type	Available Ampere Rating	Availability			Maximum Interrupting Rating (kA)		
		1-Pole	2-Pole	3-Pole	120V	120/240V	240V
BL (120V)	15, 20, 30, 40, 50, 60	✓	✓	✓	—	10	—
	70	✓	✓	✓	—	10	—
	70, 80, 90, 100	—	✓	✓	—	10	—
BL (HID)	15, 20, 30	✓	✓	—	—	—	—
BLF (GFCI)	15, 20, 30	✓	✓	—	10	—	—
	40, 50, 60	—	✓	—	10	—	—
BLE (EQGFI)	15, 20, 30	✓	✓	—	10	—	—
BGL (SWN)	15, 20, 30	—	✓	✓	10	—	—
BLR (240V)	15, 20, 30, 40, 50, 60	—	✓	—	—	—	10
	70, 80, 90, 100	—	✓	—	—	—	10
BLH (120V)	15, 20, 30, 40, 50, 60	✓	✓	✓	—	22	—
	70	✓	✓	✓	—	22	—
	70, 80, 90, 100	—	✓	✓	—	22	—
BLHF (GFCI)	15, 20, 30	✓	✓	—	—	22	—
	40, 50, 60	—	✓	—	—	22	—
HBL	15, 20, 30, 40, 50	✓	✓	✓	—	65	65
	60, 70, 80, 90, 100	—	✓	✓	—	65	65

## Subfeed Breakers — Limit One Per Panel<sup>ⓐ</sup> C1 (Not available for 42 circuit panels)

ED4	15, 20, 30, 40, 50, 60, 70, 80, 90, 100	—	✓	✓	—	—	65
	110, 125	—	✓	✓	—	—	65
HED4	15, 20, 30, 40, 50, 60, 70, 80, 90, 100	—	✓	✓	—	—	65
	110, 125	—	✓	✓	—	—	100
HHED6	15, 20, 30, 40, 50 (3-pole only)	—	—	✓	—	—	100
QR2	100, 110, 125, 150, 175, 200, 225	—	✓	✓	—	—	10
FXD6	70, 80, 90, 100, 110, 125, 150, 175, 200, 225, 250	—	✓	✓	—	—	65
	70, 80, 90, 100, 110, 125, 150, 175, 200, 225, 250	—	✓	✓	—	—	100

## Alternate Main Breaker Selection<sup>ⓑⓐ</sup> C2

Ampere Rating	Breaker Type	IR	Catalog Number	Available Trip Values
100	BQD	14	BD	50, 60, 70, 80, 90, 100
125	ED4	18	E4	50, 60, 70, 80, 90, 100, 110, 125
	ED6	25	E6	50, 60, 70, 80, 90, 100, 110, 125
	HED4	42	H4	50, 60, 70, 80, 90, 100, 110, 125
	HHED6	65	HA	50 (3-pole only)
225	FXD6	35	FX	70, 80, 90, 100, 110, 125, 150, 175, 200, 225
	HFD6	65	HF	170, 80, 90, 100, 110, 125, 150, 175, 200, 225
250	FXD6	35	FX	250
	HFD6	65	HF	250

## Branch Circuit Breakers C2

Breaker Type	Available Ampere Rating	Availability			Maximum Interrupting Rating (kA)		
		1-Pole	2-Pole	3-Pole	277V	480/277V	480V
BQD	15, 20, 30, 40, 50, 60	✓	✓	✓	14	14	—
	70, 80, 90, 100	✓	✓	✓	14	14	—

## Subfeed Breakers — Limit One Per Panel<sup>ⓑⓐ</sup> C2 (Not available for 42 circuit panels)

ED4	15, 20, 30, 40, 50, 60, 70, 80, 90, 100	—	✓	✓	—	18	18
	110, 125	—	✓	✓	—	18	18
ED6 <sup>ⓐ</sup>	15, 20, 30, 40, 50, 60, 70, 80, 90, 100	—	✓	✓	—	—	25
	110, 125	—	✓	✓	—	—	25
HED4	15, 20, 30, 40, 50, 60, 70, 80, 90, 100	—	✓	✓	—	—	42
	110, 125	—	✓	✓	—	—	42
FXD6	70, 80, 90, 100, 110, 125, 150, 175, 200, 225, 250	—	✓	✓	—	—	35
HFD6	70, 80, 90, 100, 110, 125, 150, 175, 200, 225, 250	—	✓	✓	—	—	65

ⓐ No increase in box height. Space is already built into C1 panel.

ⓑ BL, BLH, HBL and BQD are horizontally mounted. All others vertically mounted.

ⓐ Interchangeable trip breakers such as FD6 and HFD6 cannot be back fed. Must be top feed only.

ⓐ ED6/CED6 2-pole limited amps available (20-50A)

# Panelboards

## Type C1/C2

When required, special constructions or additions to standard panelboards may be specified for factory-assembled column panelboards.

### Box Modifications

Description
Gasketed Metal Card Holder
Welded Metal Card Holder
Nameplate
Al Ground Bar
Cu Ground Bar
Insulated Al Ground Bar
Insulated Cu Ground Bar

### Interior Modifications

Description
Feed-Thru Lugs
Cu Neutral Lugs
Cu main Lugs 125A
Cu main Lugs 250A

### Box Sizing Chart

Certain modifications such as subfeed breakers and feed-thru lugs require additional unit space. Use this chart to determine proper enclosure size.

Panel Configuration	Box Height (inches)
All MLO 18 Circuit	48
All MLO 30 Circuit	73
All MLO 42 Circuit	85
All MLO 18 Circuit with feed-thru lugs	73
All MLO 30 Circuit with feed-thru lugs	85
All MLO 18 Circuit with subfeed breaker	73
All MLO 30 Circuit with subfeed breaker	85
All Main Breaker 18 Circuit	48
All Main Breaker 30 Circuit	73
All Main Breaker 42 Circuit	85
All Main Breaker 18 Circuit with feed-thru lugs	73
All Main Breaker 30 Circuit with feed-thru lugs	85
All Main Breaker 18 Circuit with subfeed breaker	73
All Main Breaker 30 Circuit with subfeed breaker	85

### Breaker Kits and Accessories

Kit Number	Description	Contents
MBKQRC1FK	C1 Filler for QR in Main position 1PH or 3PH	Kit contains all cover plates necessary to change from QJ to QR both 2 and 3-pole breakers.

### Column Extension

Available in various standard lengths, extensions are 5¼ inches deep and 7 inches wide.

Height (inches)	Catalog Number <sup>①</sup>
14	LXX-14
20	LXX-20
26	LXX-26
32	LXX-32
38	LXX-38
41	LXX-41
44	LXX-44
53	LXX-53
56	LXX-56
62	LXX-62
65	LXX-65
68	LXX-68
74	LXX-74
80	LXX-80
86	LXX-86

### Pull Boxes

Two styles of pull boxes are available, top and front mounted. When the panel and its extensions are mounted in a structural WF beam a front mounted pull box is required. When the panels are surface mounted, a top mounted pull box may be used. Provisions are made so that the neutral bar may be mounted in the pull box when required. (Front mounted pull box dimensions are 14" H. X 20" W.)

Description	Catalog Number <sup>①</sup>
Top Mount	LXXP-T
Front Mount <sup>②</sup>	LXX50-F

For inches / millimeters conversion, see Application Data section.

① Must be ordered as a manual line.  
② Includes 50" extension.

# Panelboards

## Telephone and Equipment Cabinets

Selection/Dimensions

**Telephone and Equipment Cabinets:** Conform to requirements of Underwriters' Laboratories, Inc., for all cabinets and boxes bearing their label. Surface and Flush enclosures: box and front constructed of code-gauge steel, box galvanized and front only finished with light gray, ANSI-61. Cabinets provided without backboards.

**Boxes:** Standard construction has blank end walls, without knockouts.

**Fronts:** Siemens Fas Latch fronts feature concealed hinges and fastening screws. Match P1 and P2 Panels in appearance. Two locks supplied on doors more than 51 inches high.

### Cabinets

Dimensions (inches)			Surface Mount Catalog Number	Flush Mount Catalog Number
Height	Width	Depth		

#### With FAS Latch Front

29	20	5.75	TCS29B	TCF29B
41	20	5.75	TCS41B	TCF41B
47	20	5.75	TCS47B	TCF47B
59	20	5.75	TCS59B	TCF59B



### Dimensions

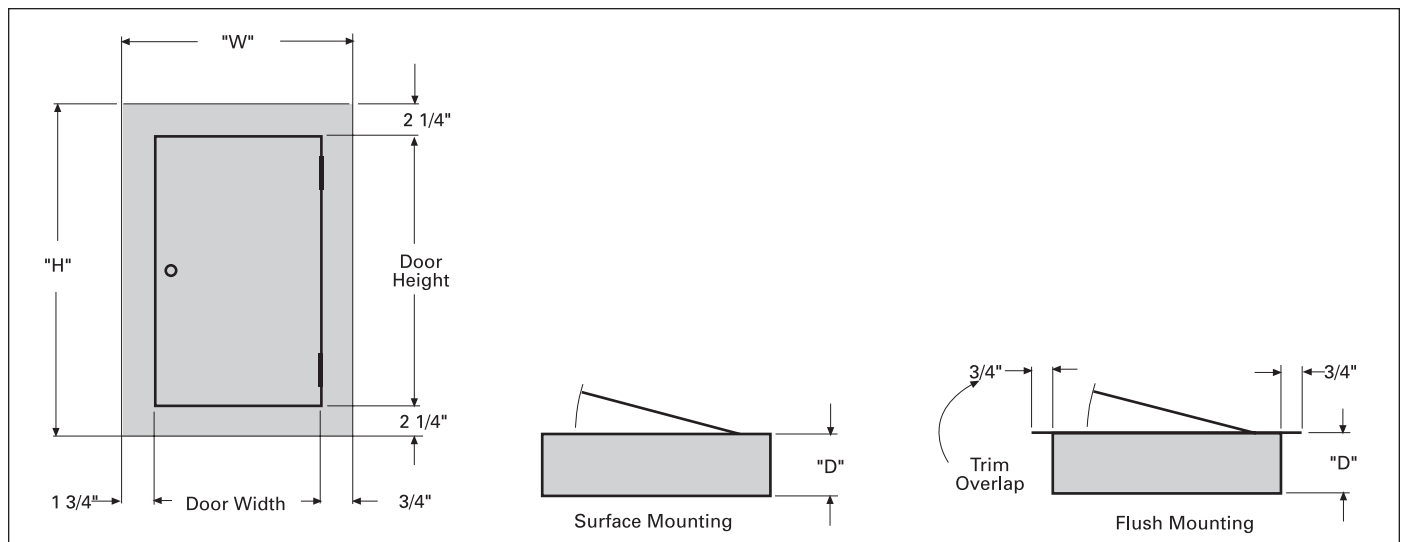

For inches / millimeters conversion, see Application Data section.

© Add S for Surface, F for Flush.

# Panelboards

## Customer Relay Cabinets

Dimensions			Catalog Number
H	W	D	
23	20	5.75	RC(1)23B <sup>①</sup>
23	24	5.75	RCW(1)23B <sup>②</sup>

Ampere Rating	ASCO #920 Mechanically held		ASCO #911 — Mechanically held remote control switch suitable for all classes of loads (Total system loads). Voltage rated to 480V AC, UL listed.	Siemens LEN Electrically Held	
	2-Pole	3-Pole	3-Pole	2-Pole	3-Pole
20	—	—	—	—	—
30	✓	✓	—	—	✓
60	✓	✓	—	—	✓
75	✓	✓	—	—	—
100	✓	✓	✓	—	✓
150	✓	✓	✓	—	—
200	✓	✓	—	—	✓
225	✓	✓	—	—	—
260	—	—	✓	—	—
300	—	—	✓	—	—
400	—	—	✓	—	—
600	—	—	✓ <sup>③</sup>	—	—
800	—	—	✓	—	—
1000	—	—	✓	—	—
1200	—	—	✓	—	—

✓ = available configurations

Application (See individual panel sections for application information)

### Remote Control Switch Modification

Description
Auxiliary Contacts (Mounted Not Wired) Ea.
2-Wire Control (add 6" to panel height.)

### Control Power Transformer

Size	VA
0,1	50
2	75
3	150
4	250

① Replace (1) with "S" for surface applications and "F" for flush applications.

② Includes Fas latch trim and steel mounting pan. If 2 or more cabinets are to be stacked in order (no extra charge for connecting hardware).

③ Available in P4 or P5 only.

# Panelboards

## Modifications and Additions

Selection

### Standard Enclosures Made From Special Materials — Type P1, P2, P3

#### Stainless Steel Options

14GA 304 SS Grade (Brush Front)	Front Front
---------------------------------	-------------

\* Stainless available only for Screw-to-Box, Hinge-to-Box, and Door-in-Door. All have piano hinges only.  
 \*\*No special sizes. 20" and 24" wide only.

#### Stainless Steel Additions to Enclosure Size (Type 1 Only)

	Lighting Panel	Distribution Panels
Width	Order in 2" increments (30" max)	Order in 2" increments
Depth	Order in 2" increments (10" max)	Order in 2" increments

Consult factory for dimension limitations.

#### Miscellaneous

Description.
Conduit Hubs — Up to 1 1/2 in. Each 2 in. to 2 1/2 in. Each 3 in. Each

#### Painted Finish

Set-up Charge Net Box Only Alternate Color Trim
-------------------------------------------------------

#### Front And Door Modifications

Two Panels with Common Trim (14 GA only) <sup>②</sup>
-------------------------------------------------------

#### Devices Mounted On Interior-Includes Device, Mounting (Wired or Unwired)<sup>①</sup>

Toggle Switch-SPST or 3-way; 15A, 277 V Maximum
Pilot Light-General Purpose, Neon or Incandescent
Pushbutton

### Gauge Steel of Boxes/Fronts, Surface and Flush (see pgs. 11-6 & 11-7)

Dimensions in Inches (mm)		Gauge Steel		
H	W	Box	Front/Door	Type
26-74 (660-1880)	20 (508)	16 <sup>①</sup>	14 <sup>⑥</sup>	Type 1
26-74 (660-1880)	20 (508)	16 <sup>②</sup>	16/14 <sup>②</sup>	Type 3R/12
32-60 (813-1524)	20-36 (508-914)	14 <sup>③</sup>	14 <sup>③</sup>	Type 4
26-74 (660-1879)	20 (508)	14 <sup>④</sup>	14 <sup>④</sup>	Type 4X
36-60 (914-1524)	30-36 (762-914)	N/A <sup>⑤</sup>	N/A <sup>⑤</sup>	Type 4X Non-Metallic

- ① 16 Gauge is Standard (14 Gauge & 12 Gauge are optional)
- ② 15 Gauge Steel Can with 14 Gauge Door or Similar Approved Construction
- ③ No Optional Gauge available
- ④ 304SS 14 Gauge Std., 316SS 14 Gauge optional
- ⑤ Sizes do not match Standard Enclosure Sizes - See Table P1-21 - material is non-metallic - No Gauge Specified.
- ⑥ FAS-Latch is 14 GA only.
- Screw-to-Box, Hinge-to-Box, Door-in-Door (14 GA Std./12 GA Std. or 10 GA Optional)  
STB/HTB/DND with Piano Hinge (14 GA Std./12 GA Optional)

**Note:** For retro fit interiors and fronts into existing can, retro fit must match or exceed minimum height, width, and depth requirements of standard Type 1 enclosures.

- ①Panels having doors over 48 in. high, 2 locks are standard.
- ② Lighting panels only. Field must supply dimensional information and panel orientation.

# Panelboards

## Circuit Breaker Accessories and Modifications

Selection

PANELBOARDS 11

### Conduit Enclosing Shield (Panel Skirts)

Sheet metal to cover conduits above or below a standard panelboard box.

Skirt Length	Width	Depth
8, 9, 11, 12, 14, 17, 18, 23, 25	20.00	5.75
26, 27, 28, 29, 30, 31, 32, 33, 34, 35, 36		
37, 38, 39, 40, 41, 42, 43, 44		
8, 9, 11, 12, 14, 17, 18, 23, 25	24.00	7.75
26, 27, 28, 29, 30, 31, 32, 33, 34, 35, 36		
37, 38, 39, 40, 41, 42, 43, 44		

### Panel Skirts Standard Configurations

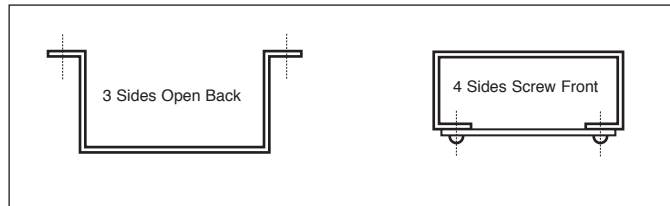

**Notes:**

- A) 4-sided skirts have standard Part Numbers (not catalog numbers).
- B) 3-sided skirts are ordered as Customer in COMPAS.
- C) Order in COMPAS with interior when possible.
- D) If ordered separate from interior, use a manual line in COMPAS.
- E) Must note if Top Entry or Bottom Entry required.

### Molded Case Switches<sup>Ⓢ</sup>

(Non-Automatic Circuit Interrupters)

When Molded case switches are substituted for thermal breakers deduct from the installed thermal breaker price:

Ampere Rating	Breaker Frame	Availability	
		3-Pole	2-Pole
100	ED2	✓	✓
	ED4	✓	✓
	ED6	✓	✓
225	QR2	✓	✓
250	FXD6	✓	✓
400	JXD2	✓	✓
	JXD6	✓	✓
600	LXD6	✓	✓
800	MD6	✓	✓
1200	ND6	✓	—

<sup>Ⓢ</sup> Available only as a main switch for non-service equipment applications. Not available for branch devices.



## QuickShip™

All SQSCP configurations of the standard NEMA 1 enclosure can be specified for shipment within 10 business days of order when specified.



<b>Mains</b>	MLO (Main Lug Only)
	Fused disconnect switch
	Non-fused disconnect switch
<b>Assembly SCCRs</b>	200kA, 100kA or 50kA AC, 100kA or 20kA@125Vdc <sup>ⓐ</sup>
<b>Voltage ratings</b>	Applicable on any 600Vac or less, or 125Vdc <sup>ⓐ</sup> or less systems
<b>Bus amperages</b>	400A, 225A, 200A, 100A, 60A or 30A
<b>Branch circuits</b>	Circuits: 18, 30 or 42*
	Amps: Up to 100A
	Type: 1-, 2- and 3-Pole
<b>Panels</b>	Feed: top & bottom
	Mounting: surface or flush
	Door/Trim: regular or door-in-door
	NEMA Ratings: 1 & 3R. Other ratings available, consult factory.
<b>Through-lugs &amp; loadside disconnect</b>	Feed-Through: single and double
	Sub-Feed
	Feed/Sub-Through
<b>Neutrals</b>	Fused loadside disconnect, (up to 1/2 of main amp rating)
<b>Grounds</b>	200A, 400A and 800A unbonded and bonded
<b>Enclosure sizes</b>	Non-isolated or isolated
<b>Spare fuses</b>	Standard size panelboard (20" W x 5 3/4" D x 33" - 69" H)*
<b>Options</b>	Spare fuse compartment holds up to six fuses
	Surge protection device (SPD) for high and low energy transients.*

ⓐ Depending on configuration.  
<sup>ⓐ</sup> 125Vdc rating applicable to only 80 amp or less CCPBs on MLO panels only.

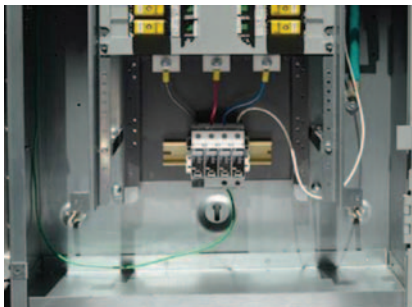

### \*Factory installed SPD options

System & Voltage	Catalog Number	Discharge Current		Response Time	SCCR	Data Sheet Number
		Nominal (I <sub>n</sub> )	Maximum (I <sub>max</sub> )			
Single-phase, 120/240	BSPM2240S3G	20 kA	40 kA	≤25 ns	200 kA	2150
Three-phase Wye, 208/120	BSPM4208WYNG					2152
Three-phase Wye, 480/277	BSPM4480WYNG					2152
Delta, 480	BSPM3480DLG					2151

## Catalog Symbol: SQSCP4

### Description

Panelboards for commercial/industrial branch or service entrance applications on systems up through 600Vac.

The SQSCP is specifically designed to address the NEC® Selective Coordination Requirements for Emergency, Legally Required Standby, Healthcare Essential Electrical and Critical Operation Power Systems (COPS) per NEC® 700.28, 701.27, 645.27 and 708.54. Not for applications requiring AFCI protected circuits. The SQSCP is configured to order for the application. To confirm availability of options and constructions, contact your Siemens distributor.

### Ratings

Volts: 600Vac (or less), 125 Vdc  
 Amps: 30, 60, 100, 200, 225, 400A  
 SCCR: 20kA or 100kA @ 125Vdc—See panelboard short circuit ratings table for AC ratings.

### Agency information

- UL 67—Standard for panelboards
- UL 50/UL 50E—Enclosures for electrical equipment
- CSA 22.2, No. 29-M1989—Panelboards and encl. panelboards
- UL listed, class CTL panelboard (meets editions of the NEC prior to 2008 with regard to the NEC® 408.15 limit of 42 overcurrent devices per panel)
- UBC and CBC Seismic Qualified and IBC Approved

### Main options

- Main lug only (MLO)
- Fused main disconnect
- Non-fused main disconnect

### Branch disconnect options

- 1-, 2-, and 3-pole 15, 20, 30, 40, 50, 60, 70, 90, and 100A rejecting branch disconnects (see table for details).  
 Branch ampacity on 125Vdc panels limited to SCCPB 80A or less.

### Branch circuit positions

- 18, 30 and 42

### Neutral options

- Unbonded and bonded 200A, 400A and 800A

### Ground options

- Isolated and non-isolated

### Enclosures

- NEMA 1 and NEMA 3R. Other ratings available. Consult factory.

### Spare fuse compartment

- Six space spare fuse compartment standard on all models

## Panelboard Short-circuit Current Ratings

SCCR	AC main options				DC
	Main lug only (MLO) <sup>①</sup>	70-200A main disc. no fuses <sup>①</sup> or w/ Class J fuses	225-400A main disc. no fuses <sup>①</sup> or w/ Class J fuses	SCCP_CF main disc. (60A) <sup>②</sup>	Main lug only (MLO) <sup>①</sup>
High	200kA	200kA	100kA	200kA	100kA
Std.	50kA	50kA	50kA	50kA	20kA

① Class J, T or RK1 fuses upstream, max amps = panel amps.  
 ② CUBEFuse® disconnect

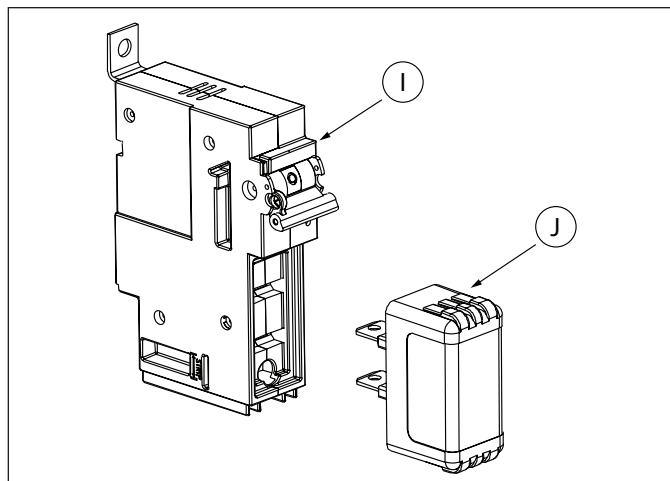

## I – CCPB Branch Disconnects

Poles	Ampacity	Part No.
1-pole	15A, 20A, 30A, 40A, 50A, 60A, 70A, 90A, 100A	SCCPB-1-(amp)CF
2-pole		SCCPB-2-(amp)CF
3-pole		SCCPB-3-(amp)CF

## J – CUBEFuse® Fuses

For CCPB® Part No.	Non-indicating Part No. STCF(amps)RN	Indicating® Part No. STCF(amps)
SCCPB-(# of poles)-15CF	STCF1RN, STCF3RN, STCF6RN, STCF10RN, STCF15RN	STCF6 STCF10 STCF15
SCCPB-(# of poles)-20CF	STCF17-1/2 RN STCF20RN	STCF17-1/2 STCF20
SCCPB-(# of poles)-30CF	STCF25RN STCF30RN	STCF25 STCF30
SCCPB-(# of poles)-40CF	STCF35RN STCF40RN	STCF35 STCF40
SCCPB-(# of poles)-50CF	STCF45RN STCF50RN	STCF45 STCF50
SCCPB-(# of poles)-60CF	STCF60RN	STCF60
SCCPB-(# of poles)-70CF	STCF70RN	STCF70
SCCPB-(# of poles)-90CF	STCF80RN STCF90RN	STCF80 STCF90
SCCPB-(# of poles)-100CF	STCF100RN	STCF100

① CCPB disconnect can accept CUBEFuses® with amp ratings less than or equal to the amp rating of the SCCPB disconnect.  
 ② 1A indicating CUBEFuse® not available. Correct fit with SCCPB disconnect requires indicating CUBEFuse® with date code R38 or later.

### Fuse and disconnect performance data

For details and specifications, access the following data sheets online at [www.usa.siemens.com/panelboards](http://www.usa.siemens.com/panelboards)

### CUBEFuse® Specifications Catalog Symbols

**STCF\_** (6-100A Indicating version)  
**STCF\_RN** (1-100A Non-indicating version)

### Description

The CUBEfuse® is a finger-safe, dual-element, time delay UL Class CF power fuse with Class J fuse electrical performance characteristics. 10 Seconds minimum operating time at 500% rated current.

### Ratings

Volts: 600Vac/300Vdc  
 Amps: 1-100 (non-indicating version)  
 6-100 (indicating version)  
 IR: 300kA RMS Sym. (UL)  
 200kA RMS. Sym (CSA)  
 100kA DC (UL & CSA)

### Agency Information

- UL Listed Special Purpose Fuse: Guide JFHR, File E56412
- CSA Certified Fuse: Class 1422- 02, File 53787
- CE compliance for the European Union low voltage directive

### Other Ratings/Specifications

Watts Loss at rated current: STCF30: 3.99W  
 STCF60: 6.23W  
 STCF100: 9.51W

### Operating and Storage Temperature Range

14 to 149°F (-10 to 65°C)

### Material Specifications

- Case: Glass filled PES (Polyethersulfone)
- Terminals: Copper alloy
- Terminal plating: Electroless tin
- Indicator lens: PES (Polyethersulfone) (indicating version only)
- Indicator: Energetic chemical

*CUBEFuse®, Low-Peak®, Quik-Spec™, QuickShip™, and easyID™ are valuable trademarks of Cooper Industries in the United States and other countries.*

# Panelboards

SCCPB Branch Disconnects, CUBEFuse®

Specifications

11  
PANELBOARDS

## SCCPB Horsepower Ratings

SCCPB Disconnect	Amp Rating	HP Rating @ Vac			
		120	240	480	600
SCCPB-(poles)-15CF	15	0.5	3	5	7.5
SCCPB-(poles)-20CF	20	0.75	3	7.5	10
SCCPB-(poles)-30CF	30	1.5	5	15	10
SCCPB-(poles)-40CF	40	2	7.5	20	10
SCCPB-(poles)-50CF	50	3	7.5	20	10
SCCPB-(poles)-60CF	60	3	7.5	20	10
SCCPB-(poles)-70CF	70	3	15	30	40
SCCPB-(poles)-90CF	80	5	20	40	50
SCCPB-(poles)-100CF	100	5	20	50	50

## Branch Disconnects

SCCPB <sup>①</sup> Part No.	Poles	Fuse Amp Range	Max. SCCBP Amp.	Non-indicating Fuses (Standard)	Indicating Fuses (Opt'l) <sup>②</sup>
SCCPB-1-15CF	1	1-15	15	STCF1RN, STCF3RN, STCF6RN, STCF10RN, STCF15RN	STCF6 STCF10 STCF15
SCCPB-2-15CF	2				
SCCPB-3-15CF	3				
SCCPB-1-20CF	1	17.5-20	20	STCF17-1/2 RN STCF20RN	STCF17-1/2 STCF20
SCCPB-2-20CF	2				
SCCPB-3-20CF	3				
SCCPB-1-30CF	1	25-30	30	STCF25RN STCF30RN	STCF25 STCF30
SCCPB-2-30CF	2				
SCCPB-3-30CF	3				
SCCPB-1-40CF	1	35-40	40	STCF35RN STCF40RN	STCF35 STCF40
SCCPB-2-40CF	2				
SCCPB-3-40CF	3				
SCCPB-1-50CF	1	45-50	50	STCF45RN STCF50RN	STCF45 STCF50
SCCPB-2-50CF	2				
SCCPB-3-50CF	3				
SCCPB-1-60CF	1	60	60	STCF60RN	STCF60
SCCPB-2-60CF	2				
SCCPB-3-60CF	3				
SCCPB-1-70CF	1	70	70	STCF70RN	STCF70
SCCPB-2-70CF	2				
SCCPB-3-70CF	3				
SCCPB-1-90CF	1	80-90	90	STCF80RN STCF90RN	STCF80 STCF90
SCCPB-2-90CF	2				
SCCPB-3-90CF	3				
SCCPB-1-100CF	1	100	100	STCF100RN	STCF100
SCCPB-2-100CF	2				
SCCPB-3-100CF	3				

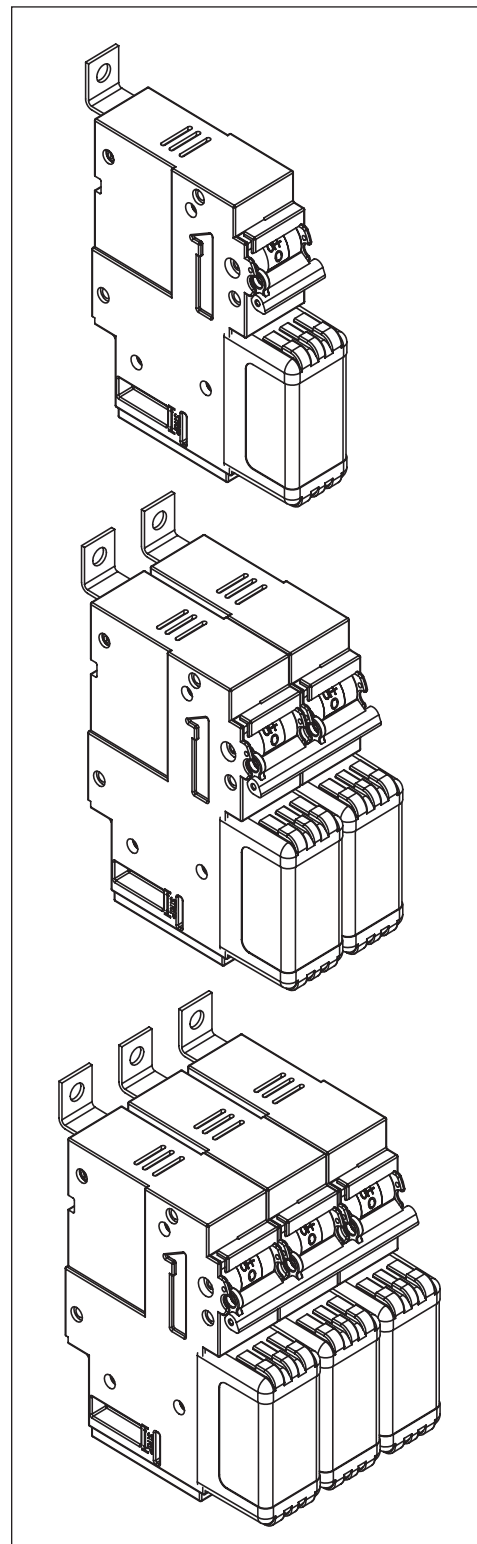

① SCCPB disconnect can accept CUBEFuses® with amp ratings less than or equal to the amp rating of the SCCPB disconnect.  
 ② Correct fit with SCCPB disconnect requires indicating CUBEFuses® with date code R38 or later.

# Panelboards

## Enclosure/System Types, AC & DC Voltages

### NEMA 1

- Flush or surface mount.
- Galvanized steel with removable end walls –blank or with knockouts to order.
- Box sizes: 20" W x 5.75" D x 33", 50", 59" or 69" H (510 W x 145 D x 838, 1270, 1500 or 1753mm H). Box can be rotated 180° to accommodate conduit feed.
- Enclosure and chassis mounting instructions are found in supplied literature.
- Chassis mounts directly onto studs in the enclosure.
- Trim finished with gray powder coat paint over phosphatized steel (ANSI 61).
- Door and door-in-door configurations with locks.
- Door locks use key #2A1910-2.
- Circuit directory card is located on the inside of the door.
- Trim screws are concealed.

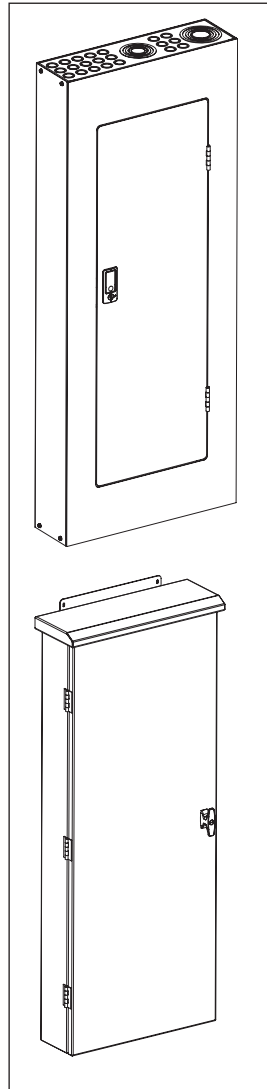

### NEMA 3R

- Surface mount only.
- Finished with gray powder coat paint over phosphatized steel (ANSI 61).
- Bottom feed only, no knockouts
- Box sizes: 20" W x 7.7" D x 34.5", 51.5", 60.5" or 70.5" H (510 W x 195 D x 876, 1310, 1535 or 1791mm H).
- Enclosure and chassis mounting instructions are found in supplied literature
- Chassis mounts directly onto studs in the enclosure.
- Gasketed door has vault handle with lock.
- Door locks use key #2A1910-1.
- Circuit directory card is located on the inside of the door.

### Busing

Tin-plated copper with sufficient cross section to meet UL 67 temperature rise requirements.

Distributed 1- & 3-phase busing

All SCCPB branch disconnects can be mounted in any branch circuit position.

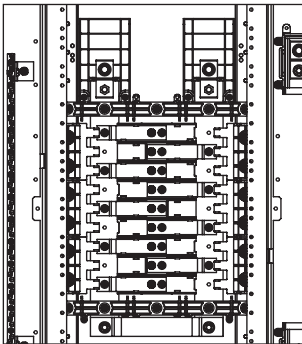

Single-phase

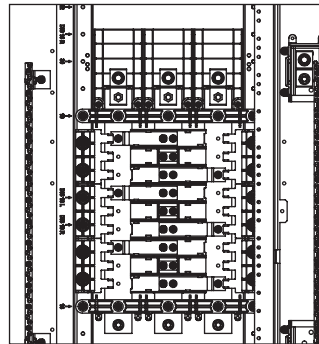

Three-phase

### AC Voltages

#### 1 phase, 2 wire

- 120V 1 phase, 2 wire
- 240V 1 phase, 2 wire

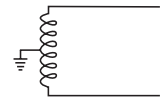

#### 1 phase, 3 wire

- 120/240V 1 phase, 3 wire

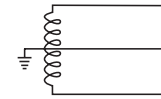

#### 1 phase, 2 wire, Wye

- 277V 1 phase, 2 wire

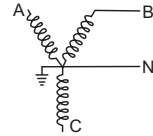

#### 1 phase, 2 wire, Delta

- 480V 1 phase, 2 wire

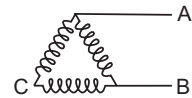

#### 1 phase, 3 wire, Delta

- 240/480V 1 phase, 3 wire

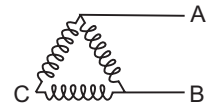

#### 3 phase, 4 wire, Wye

- 208Y/120V 3 phase, 4 wire
- 480Y/277V 3 phase, 4 wire
- 600Y/347V 3 phase, 4 wire

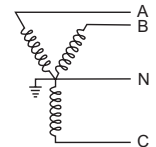

#### 3 phase, 4 wire, Delta

- 240/120V 3 phase, 4 wire
- 480/240V 3 phase, 4 wire

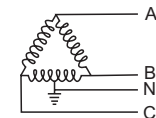

#### 3 phase, 3 wire, Delta

- 240V, 3 phase, 3 wire
- 480V, 3 phase, 3 wire
- 600V, 3 phase, 3 wire
- 240V, 3 phase, 3 wire, grounded B
- 480V, 3 phase, 3 wire, grounded B
- 600V, 3 phase, 3 wire, grounded B

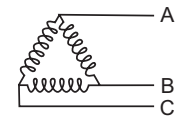

#### 1 phase, 3 wire, Wye

- 208Y/120V 1 phase, 3 wire
- 480Y/277V 1 phase, 3 wire

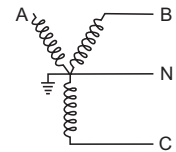

### DC voltage

#### 1 phase, 2 wire

- 125Vdc, 2 wire

(Up to 125Vdc, MLO option only, SCCPB 40A or less.)

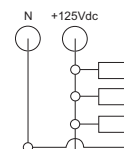

# Panelboards

## Dimensions and Panelboard Configurations

### NEMA 1 and 3R Enclosure Dimensions

Encl. Type	Encl. Height	Dimensions (inches)			CH	DH	RH	SH	DW	D
		H	HC	MH						
NEMA 1	33	33.0	N/A	29.0	26.0	28.9	25.0	2.0	20.0	5.7
	50	50.0	N/A	43.0	40.0	37.9	39.0	3.5	20.0	5.7
	59	59.0	N/A	52.0	49.0	46.9	48.0	3.5	20.0	5.7
	69	69.0	N/A	62.0	59.0	56.9	58.0	3.5	20.0	5.7
NEMA 3R	33	33.0	34.5	35.5	26.0	28.9	25.0	2.0	20.0	6.3
	50	50.0	51.5	52.5	40.0	37.9	39.0	2.0	20.0	6.3
	59	59.0	60.5	61.5	49.0	46.9	48.0	2.0	20.0	6.3
	69	69.0	70.5	71.5	59.0	56.9	58.0	2.0	20.0	6.3

### Available panelboard configurations

Based on enclosure height, panel amp rating and number of branch circuit positions

Encl. height (inches)	Panel amp rating	Branch positions	Available configurations	
33"	30-200	18	· Main lug only, with or without feed-through lugs · Non-fused disconnect, no loadside options	
		30	· Main lug only, no loadside options	
50"	30-60	18	· 30 through 60A fused main disconnect with or without feed-through lugs or TVSS device	
		30	· 30 through 60A fused main disconnect with or without feed-through lugs or TVSS device	
		42	· 30 through 60A fused main disconnect with or without feed-through lugs or TVSS device	
	70-200	18	· 70 through 200A fused main disconnect with or without feed-through lugs or TVSS device	
		30	· 70 through 200A fused disconnect with or without feed-through lugs	
	30-200	18	· Main lug only with TVSS device · Non-fused disconnect, with feed-through lugs or TVSS device	
		30	· Main lugs only, with feed-through lugs or TVSS device · Non-fused disconnect, with or without feed through lugs	
		42	· Main lug only, with or without feed-through lugs or TVSS device · Non-fused disconnect, with or without feed-through lugs	
		225-400A	18	· Main lug only, with or without feed through lugs or TVSS device · Non-fused disconnect, with or without feed-through lugs
			30	· Main lug only, with or without feed-through lugs
59"	70-200	30	· 70 through 200A fused main disconnect, with TVSS device	
		42	· 70 through 200A fused main disconnect with or without feed-through lugs or TVSS device	
	30-200	42	· Non-fused disconnect with TVSS device	
		225-400A	18	· Main lug only with loadside disconnect · Non-fused disconnect, with TVSS device · 225 through 400A fused disconnect with or without feed-through lugs or TVSS device
			30	· Main lug only, with TVSS device · 225 through 400A fused disconnect, with no loadside options
			42	· Main lug only, with or without feed-through lugs or TVSS device · Non-fused disconnect, with no loadside options
69"	225-400A	18	· Non-fused disconnect, with loadside disconnect	
		30	· Main lug only with loadside disconnect · 225 through 400A fused disconnect with feed-through lugs or TVSS device	
		42	· Non-fused disconnect, with or without feed through lugs or TVSS device · 225 through 400A fused main disconnect, with or without feed-through lugs or TVSS device	

# Panelboards

NEMA 1 and NEMA 3R

Dimensions

11  
PANELBOARDS

## NEMA 1 Enclosures and Interior

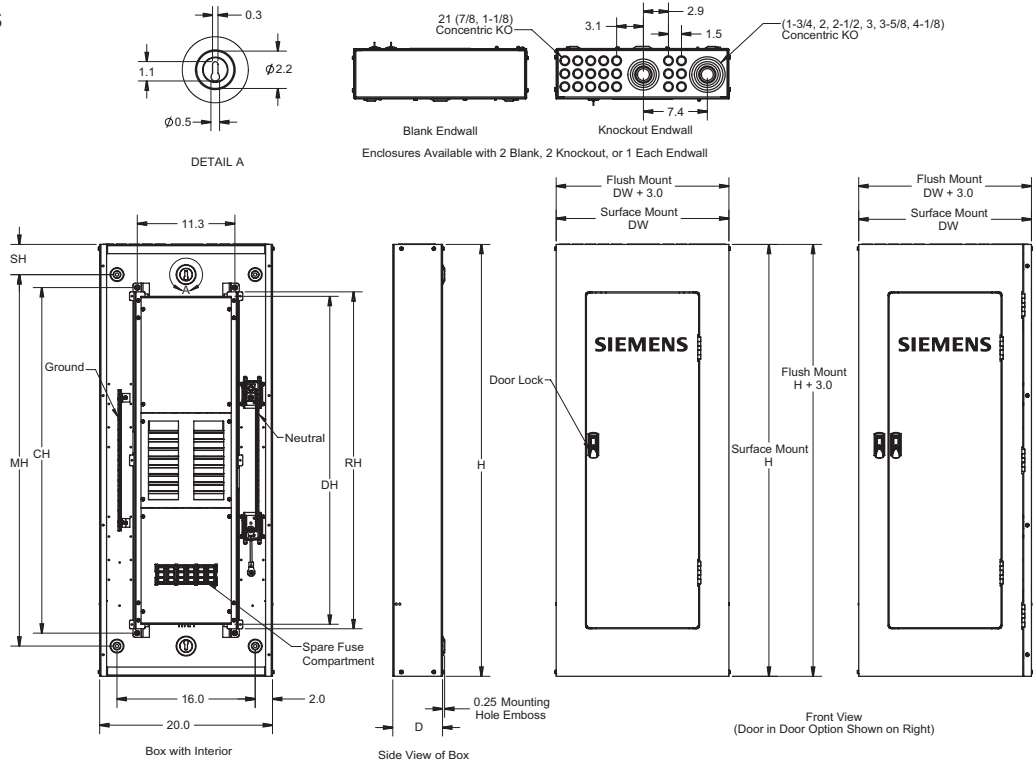

## NEMA 3R Enclosures Interior same as NEMA 1

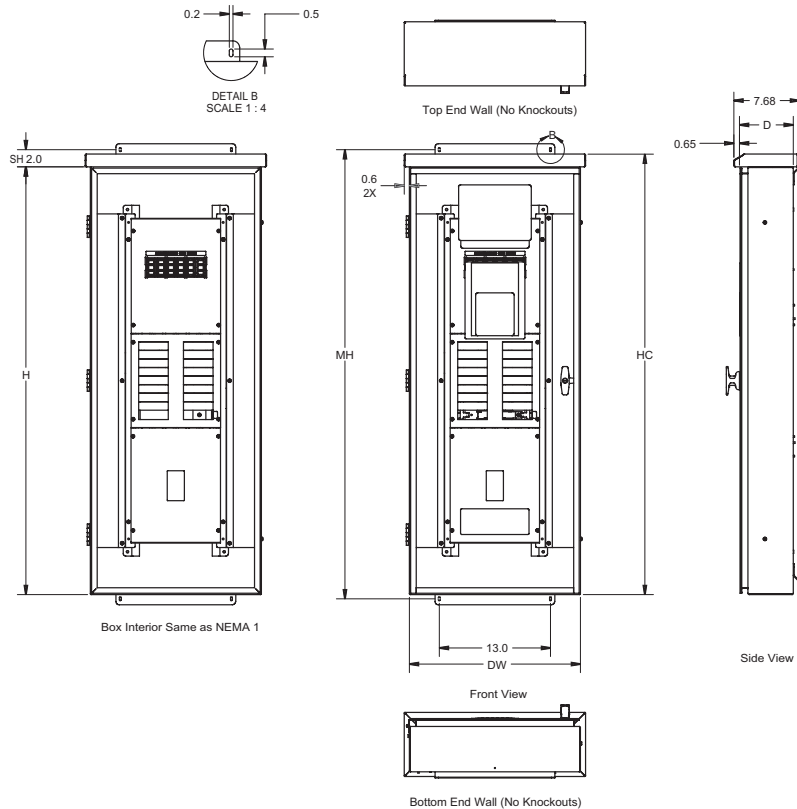

# Panelboards

## Fuse Curves

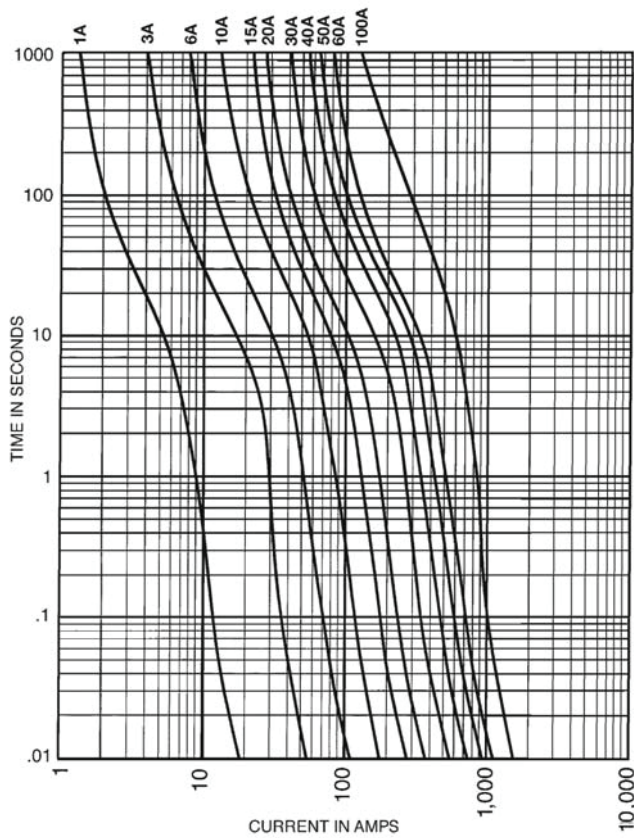

Time-Current Characteristic Curves—  
Average Melt

## Current Limitation Curves

