



PART No. C3RWT1260

for more information visit
www.hammfg.com

Data subject to change without notice

Isometric drawing Not to Scale

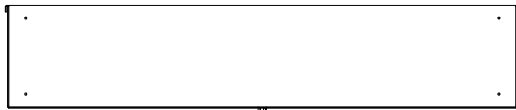

REAR VIEW

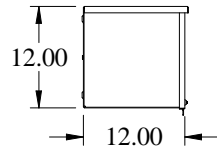

SIDE VIEW

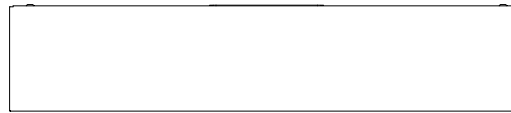

TOP VIEW

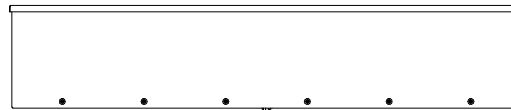

FRONT VIEW

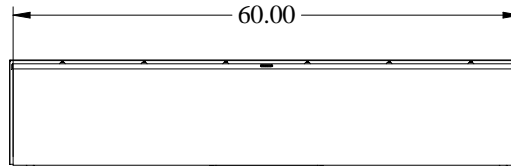

BOTTOM VIEW

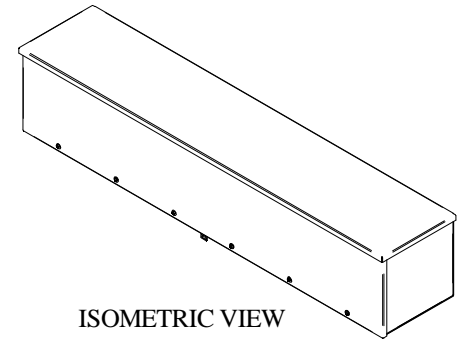

ISOMETRIC VIEW

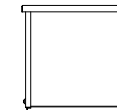

SIDE VIEW