

8

7

6

5

4

3

NOTES:

1. DIMENSIONS AND TOLERANCES IN ACCORDANCE WITH ANSI Y14.5M-1982.
2. ALL PRINTING TO BE BLACK ON WHITE BACKGROUND.
3. SUBMIT PROOFS TO ENGINEERING FOR APPROVAL.
4. SEE TABLE FOR BAR CODE NUMBERS.

REV	DESCRIPTION	DATE	APPROVED
4P	REVISED AND REDRAWN ON D SIZE FORMAT.	9/23/93 CWL	ALH
5P	REVISED 800496B01: PICTORIAL & .18 OR .25 DIA. WAS .19 DIA.	3/7/94 MR	ALH
6P	REMOVED CAT. NO. CQDBMB IN BOM, TABLE, AND AT ZONES A3-A8 & B3-B8.	6/19/96 PRJ	
7P	ECN 19946 Added NGG breaker A02 was A01, B02 was B01	7/15/05	
8P	ECN 19949 Added danger symbol, A03 was A02, B03 was B02	8/15/05	
9P	ECN 20027, added NGB to use with list, A04 was A03, B04 was B03	10/15/05	
10P	ECN 21087; PC.NO. 800496A04 DC# ON ARTWORK WAS 78364327806 & REMOVED "REV.NO. 9P" FROM ARTWORK; PC.NO. 800496B04 REMOVED "REV.NO. 9P" FROM ARTWORK; PC.NO. 800496D00 REMOVED "REV.NO. 5P" FROM ARTWORK & PRINT; PC.NO. 800496E00 REMOVED "REV.NO. 5P" FROM ARTWORK & PRINT; PC.NO. 800496F00 REMOVED "REV.NO. 5P" FROM ARTWORK & PRINT; PC.No. 800496G01 WAS 800496G00; DC# ON PDF FILE & PRINT WAS 78364327807; REMOVED "REV.NO. 5P" FROM ARTWORK; REMOVED BAR CODE ON ALL PC.NO'S.	12.03.08	M.ELSON

SIEMENS

Molded Case Circuit Breaker Accessory

Screw Mounting Kit
Each kit contains (4) #6-32 UNC and (2) Standoffs for use with CQD Circuit Breakers only.

NOTE: When used on a 2 pole CQD use only 2 screws and 1 spacer. This kit can not be used on a 1 pole CQD.
Use template on reverse side to locate and drill mounting holes.
Torque mounting screws to 8 in.-lbs.

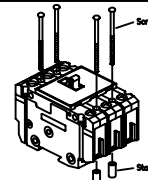

Qty. Cat. No. DC No.
1 CQDSMK 78364327905

Siemens Energy & Automation, Inc.
Bellefontaine, Ohio 43311 USA P.C. No. 800496000

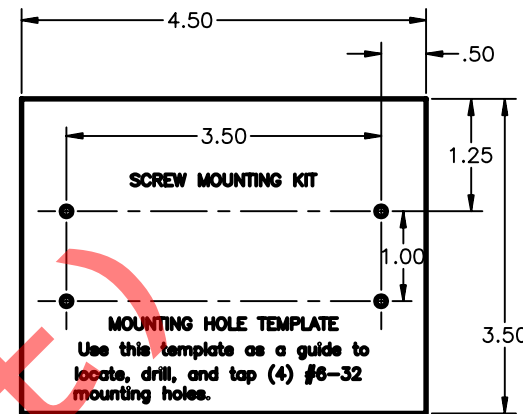

CAT. NO.	PART NO.	DC NO.	BAR CODE NO.
BQDHBD	800496A04	78364327805	
BQDPLD	800496B04	78364327806	
CQDFMB1	800496D00	78364327808	
CQDFMB2	800496E00	78364327894	
CQDFMB3	800496F00	78364327895	
CQDSMK	800496G01	78364327905	

800496G01

SIEMENS

Molded Case Circuit Breaker Accessory

Handle Blocking Device
Each kit contains (1) one Handle Blocking Device for use with type B0D, CQD, NGG and NGB Circuit Breakers

NOTE: This device can be used to block the handle in either the "ON" or "OFF" positions.
Instructions:
1. Slide BQDHBD over handle and align in notch.
2. Tighten screw to 6 lb-in.



Qty. Cat. No. DC No.
1 BQDHBD 78364327805

Siemens Energy & Automation, Inc.
Bellefontaine, OH, 43311 USA Technical Support 1-800-964-4114 P.C. No. 800496A04

800496A04

SIEMENS

Molded Case Circuit Breaker Accessory

Handle Padlocking Device
Each kit contains (1) one Padlocking Device for use with type B0D, CQD, NGG and NGB Circuit Breakers

NOTE: This device can be used to padlock the circuit breaker in the "OFF" position when installed under the deadfront of an enclosure or panelboard.
Instructions: 1. Remove deadfront of enclosure or panelboard.
2. Install BQDPLD over catchhook of the circuit breaker.
3. Reinstall deadfront.
4. To secure breaker handle in OFF position use a lock with 1/8 or 3/32 dia. tang in hole provided.
5. To remove, use slot provided in BQDPLD.

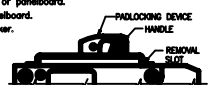

Qty. Cat. No. DC No.
1 BQDPLD 78364327806

Siemens Energy & Automation, Inc.
Bellefontaine, OH, 43311 USA Technical Support 1-800-964-4114 P.C. No. 800496B04

800496B04

CQDSMK	800496G01	110 LB INDEX
CQDFMB3	800496F00	110 LB INDEX
CQDFMB2	800496E00	110 LB INDEX
CQDFMB1	800496D00	110 LB INDEX
BQDPLD	800496B04	110 LB INDEX
BQDHBD	800496A04	110 LB INDEX
CAT. NO. (REF)	PART OR IDENTIFYING NO.	MATERIAL/SPECIFICATION

CONFIDENTIAL - PROPERTY OF SIEMENS ENERGY & AUTOMATION, INC.

Siemens Energy & Automation, Inc.
Circuit Protection & Controls Division

BQD/CQD EXTERNAL ACCESSORY INSTRUCTION SHEETS

UNLESS OTHERWISE SPECIFIED DIMENSIONS ARE IN INCHES
TOLERANCES:
.xx ±.01
.xxx ±.005
ANGULAR ±1°
DO NOT SCALE DRAWING

DWN C KEMMER	DATE 9/29/92	SIZE FSCM NO.	DWG NO.	REV
CHK A HALL	DATE 9/29/92	D	800496	10P
APVD A HALL	DATE 9/29/92	SCALE 1/1	SHEET 1	OF 2

REVISIONS			
REV	DESCRIPTION	DATE	APPROVED
4P	SEE SHEET 1 FOR CHANGES.	CWL 9/23/93	ALH
5P	SEE SHEET 1 FOR CHANGES.	MR 3/7/94	ALH
6P	SEE SHEET 1 FOR CHANGES.	PRJ 6/19/96	

SEE SHEET 1 FOR REVISION INFORMATION.

SIEMENS

Molded Case Circuit Breaker Assembly
Face Mounting Bracket - 1 Pole
Each kit contains one (1) Face Mounting Bracket Kit for use with CQD Circuit Breakers only.

NOTES:
1. Use the template provided on the reverse side to locate the mounting holes.

INSTALLATION INSTRUCTIONS:
1. Retract locking clip prior to installation.
2. Place bracket onto face of CQD Circuit Breaker.
3. Slide bracket toward Line End of breaker and engage bracket into slot in the end of the escutcheon.
4. Push Locking Clip into slot in the end of the escutcheon.
5. Clip will snap over Locking Tabs when pushed into escutcheon.
6. Mount the CQD Circuit Breaker using (4) #6-32 tapped holes in bracket.

Qty. 1 Cat. No. CQDFMB1 DC No. **78364327808**

Siemens Energy & Automation, Inc.
Munich, Germany, Ohio 43111 USA Pc. No. 800496D00

800496D00

SIEMENS

Molded Case Circuit Breaker Assembly
Face Mounting Bracket - 2 Pole
Each kit contains one (1) Face Mounting Bracket Kit for use with CQD Circuit Breakers only.

NOTES:
1. Use the template provided on the reverse side to locate the mounting holes.

INSTALLATION INSTRUCTIONS:
1. Retract locking clip prior to installation.
2. Place bracket onto face of CQD Circuit Breaker.
3. Slide bracket toward Line End of breaker and engage bracket into slot in the end of the escutcheon.
4. Push Locking Clip into slot in the end of the escutcheon.
5. Clip will snap over Locking Tabs when pushed into escutcheon.
6. Mount the CQD Circuit Breaker using (4) #6-32 tapped holes in bracket.

Qty. 1 Cat. No. CQDFMB2 DC No. **78364327804**

Siemens Energy & Automation, Inc.
Munich, Germany, Ohio 43111 USA Pc. No. 800496E00

800496E00

SIEMENS

Molded Case Circuit Breaker Assembly
Face Mounting Bracket - 3 Pole
Each kit contains one (1) Face Mounting Bracket Kit for use with CQD Circuit Breakers only.

NOTES:
1. Use the template provided on the reverse side to locate the mounting holes.

INSTALLATION INSTRUCTIONS:
1. Retract locking clip prior to installation.
2. Place bracket onto face of CQD Circuit Breaker.
3. Slide bracket toward Line End of breaker and engage bracket into slot in the end of the escutcheon.
4. Push Locking Clip into slot in the end of the escutcheon.
5. Clip will snap over Locking Tabs when pushed into escutcheon.
6. Mount the CQD Circuit Breaker using (4) #6-32 tapped holes in bracket.

Qty. 1 Cat. No. CQDFMB3 DC No. **78364327805**

Siemens Energy & Automation, Inc.
Munich, Germany, Ohio 43111 USA Pc. No. 800496F00

800496F00

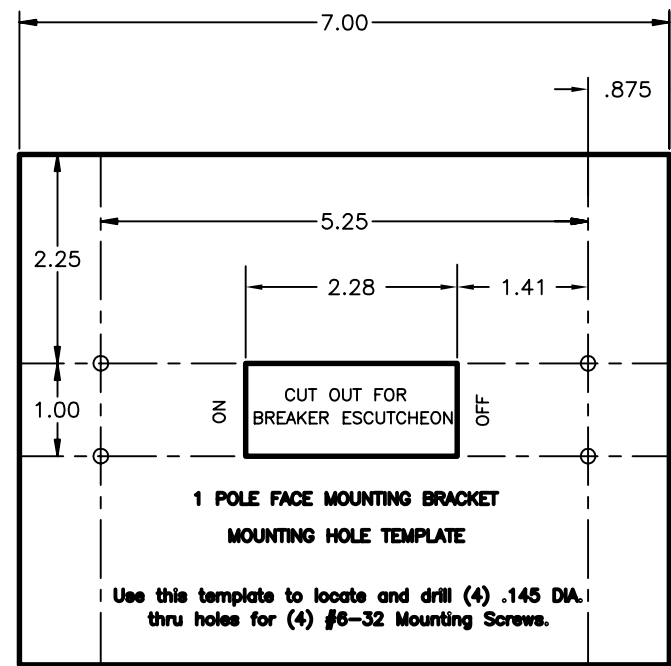

800496D00
REVERSE SIDE

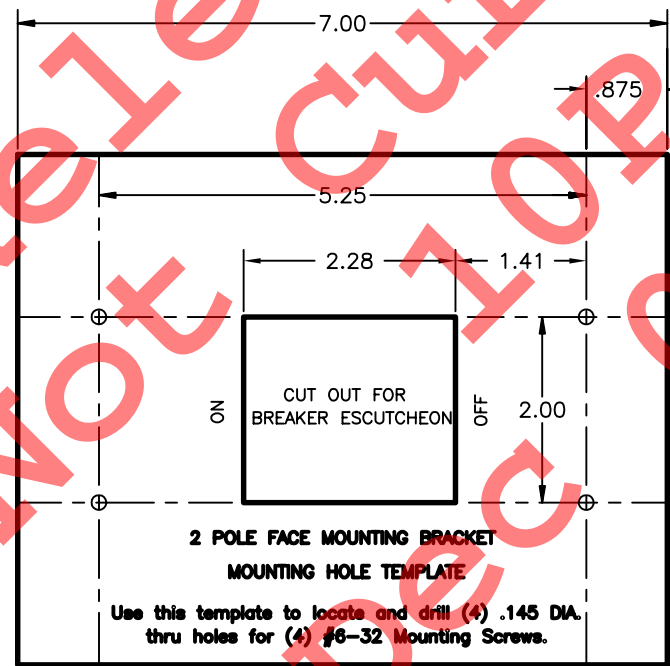

800496E00
REVERSE SIDE

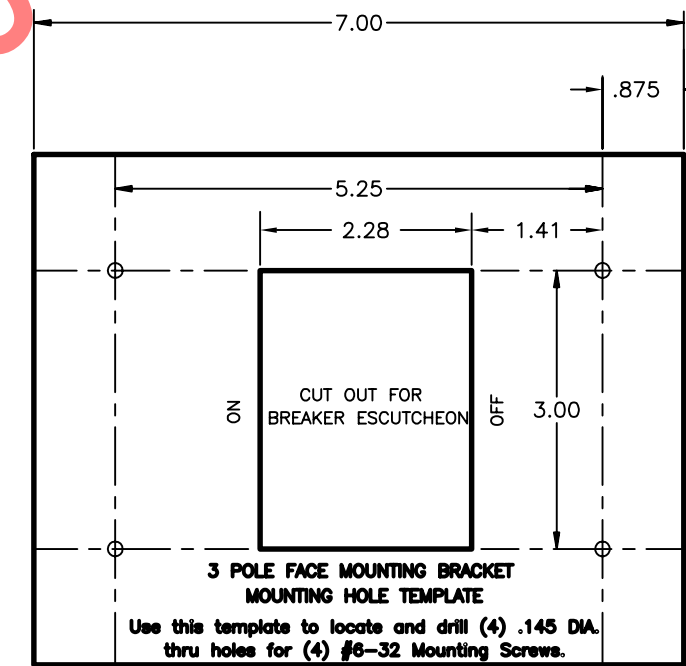

800496F00
REVERSE SIDE

CONFIDENTIAL - PROPERTY OF SIEMENS ENERGY & AUTOMATION, INC.

UNLESS OTHERWISE SPECIFIED DIMENSIONS ARE IN INCHES
TOLERANCES:
.xx ±.01
.xxx ±.005
ANGULAR ±1°
DO NOT SCALE DRAWING

Siemens Energy & Automation, Inc.
Circuit Protection & Controls Division

BQD/CQD EXTERNAL ACCESSORY INSTRUCTION SHEETS

DWN C KEMMER	DATE 9/29/92	SIZE FSCM NO.	DWG NO. 800496	REV 10P
CHK A HALL	DATE 9/29/92	SCALE 1/1	SHEET 2 OF 2	
APVD A HALL	DATE 9/29/92			

(NOT RELEASED TO PUBLIC) 2008