



Main

Range of product	Harmony 9001K
Product or component type	Selector switch
Device short name	K
Type of operator	maintained
Operator profile	Black standard knob

Complementary

Bezel material	Chromium plated metal
Mounting diameter	1.18 in (30 mm)
Operator position information	3 positions
Contacts type and composition	Without contact block
Device presentation	Basic element

Environment

NEMA degree of protection	NEMA 1/2/3/3R/4/6/12/13
Product certifications	UL listed file E42259 CCN NKCR CSA LR24590 class 3211 03 CE

Ordering and shipping details

Category	21426 - 9001 K (NOT KA,KM,KX)
Discount Schedule	CS1
GTIN	00785901322696
Nbr. of units in pkg.	1
Package weight(Lbs)	0.27 lb(US) (0.12 kg)
Returnability	Yes
Country of origin	MX

Packing Units

Unit Type of Package 1	PCE
Package 1 Height	2.80 in (7.112 cm)
Package 1 width	2.30 in (5.842 cm)
Package 1 Length	2.10 in (5.334 cm)

The information provided in this documentation contains general descriptions and/or technical characteristics of the performance of the products contained herein. This documentation is not intended as a substitute for and is not to be used for determining suitability or reliability of these products for specific user applications. It is the duty of any such user or integrator to perform the appropriate and complete risk analysis, evaluation and testing of the products with respect to the relevant specific application or use thereof. Neither Schneider Electric Industries SAS nor any of its affiliates or subsidiaries shall be responsible or liable for misuse of the information contained herein.

Offer Sustainability

Sustainable offer status	Green Premium product
California proposition 65	WARNING: This product can expose you to chemicals including: Nickel compounds, which is known to the State of California to cause cancer, and Di-isodecyl phthalate (DIDP), which is known to the State of California to cause birth defects or other reproductive harm. For more information go to www.P65Warnings.ca.gov
REACH Regulation	REACH Declaration
EU RoHS Directive	Pro-active compliance (Product out of EU RoHS legal scope) EU RoHS Declaration
Mercury free	Yes
RoHS exemption information	Yes
China RoHS Regulation	China RoHS Declaration
Environmental Disclosure	Product Environmental Profile
WEEE	The product must be disposed on European Union markets following specific waste collection and never end up in rubbish bins.

Contractual warranty

Warranty	18 months
----------	-----------

Approximate Dimensions

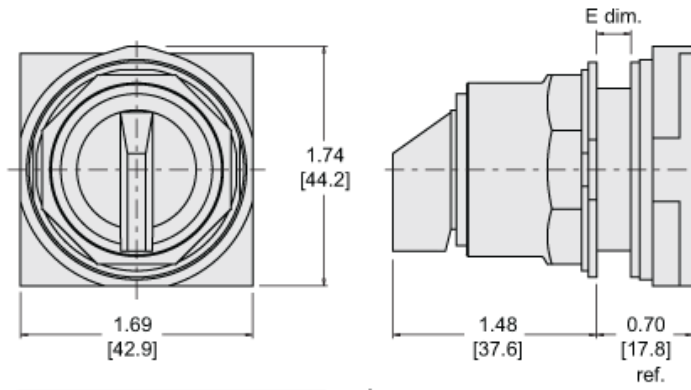

Panel Thickness E dim. in. [mm]	Number of Gasket
1/16 [1.6]	4
1/8 (3.2)	3
3/16 (4.8)	2
1/4 (6.4)	1

in.
[mm]