

PRICE LIST
USP-0215-IP



IPEX SPECIALTY PLUMBING



FEBRUARY 9, 2015
SUPERCEDES USP-109 (APRIL 1, 2014)

www.ipexamerica.com

SPECIALTY PLUMBING PRODUCTS

PRICE LIST USP-0215-IP FEBRUARY 9, 2015

TERMS AND CONDITIONS OF SALE

TERMS

Cash discount 2% 10 days, net 30. The cash discount is allowed on merchandise only. Prices are subject to change and each order will be priced on the basis of prices in effect at the time of order. All orders are subject to approval of our office in Denver, CO. Possession of this price list does not necessarily constitute an offer by the Company to sell to the holder on the basis of the terms described hereon.

MINIMUM ORDER

\$150.00 net.

TAXES

Any and all sales, manufacturers' taxes and/or other charges levied or imposed by any governmental authority, foreign or domestic, upon any merchandise sold or contacted to be sold shall be paid by Customer and added to the purchase price unless satisfactory and appropriate tax exception certificates are supplied to the Seller.

OVERDUE INVOICES

Interest charged at a rate of 1.5% per month on all overdue invoices.

FREIGHT

\$500.00 net for prepaid freight.

All shipments are F.O.B. seller's factory or authorized warehouse.

Prepaid orders will be shipped via the most economical route of our choice. If the Customer selects a route with a higher rate, the difference will be charged to the Customer.

SHIPPING RESPONSIBILITY

The responsibility of IPEX USA LLC. ceases when the carrier signs for the shipment in good order. We cannot be responsible for loss or damage to goods in transit, or delays or carriers in delivering shipments or for damages resulting from such delays as those caused by fire, explosion, act of God, strike or other difference with workmen, shortage of material or labor, delays in transportation, government restrictions, war, riot, civil commotion or cause beyond our control. Where shortage or damage is apparent, details should be noted by the carrier on the freight bill at the time of delivery. In case of concealed damage, carrier should be called at once to inspect the damaged shipment. Do not return damaged goods.

RETURNED GOODS

A Returned Goods Authorization Form issued by IPEX USA LLC. must accompany goods which are returned. We reserve the right to refuse the return of any item that is not a regular stock item with IPEX USA LLC.. On items that are acceptable for credit, a restocking charge of twenty-five percent (25%) will be assessed against the credit to cover our handling, and/or inspecting or repackaging. Freight on returned goods will be the responsibility of the customer unless the reason for the return is due to defective goods. All goods returned must be in a saleable condition.

WARRANTY

Seller's products are carefully inspected for manufacturing defects, however, it is not always possible to detect hidden defects. Said products are warranted only to the extent that Seller will replace without charge, products proven to have manufacturing defects within 6 months of the date of delivery thereof and provided Seller has been given an opportunity to inspect the product alleged to be defective and the installation or use thereof. NO WARRANTY IS INCLUDED AGAINST ANY EXPENSE FOR REMOVAL, REINSTALLATION OR OTHER CONSEQUENTIAL DAMAGES ARISING FROM ANY DEFECT. THE WARRANTIES SET OUT ABOVE ARE THE ONLY WARRANTIES MADE BY SELLER AND ARE EXPRESSLY IN LIEU OF ALL OTHER WARRANTIES, EXPRESSED OR IMPLIED, INCLUDING THE WARRANTIES OF MERCHANTABILITY AND FITNESS FOR A PARTICULAR PURPOSE.

IPEX USA LLC. reserves the right to change the aforementioned TERMS AND CONDITIONS OF SALE without notice.

CAUTION

The Seller does not recommend the use of thermoplastic piping systems for transport or storage of compressed air or other compressed gases or the testing of such systems with compressed air or other compressed gases, in exposed, above ground locations. Use of plastic piping products in exposed compressed gas systems voids our warranty for the products so used. For further information, contact your IPEX USA LLC. representative.

OTHER

In addition to sizes listed in this price list, other sizes may be available upon request.

The product names used in this price list are for identification purposes only. All trademarks and registered trademarks are the property of their respective owners.

TABLE OF CONTENTS Page

AIR ADMITTANCE VALVES	3
SPECIALTY REPAIR FLANGE RINGS CLOSET FLANGES	4
VENT PIPE CAP	4
CLOSET FLANGES	5
SHOWER DRAINS	6
UTILITY DRAINS & CLEANOUTS	7
FLOOR DRAINS	7
FLOOR SINKS	8
BELL TRAP DRAINS	8
CLEANOUT PLUGS	8
CAST COVERALL DRAINS & CLEANOUTS	9
ADAPTERS	9
APPLIANCE FITTINGS/TERMINATION SCREENS	10
EXPANSION JOINTS	11
URINAL FLANGE KITS	12
REDUCING LINE CLEANOUT WITH TEST MEMBRANE	13
GASKETED LINE CLEANOUTS	13
TEST TEES	14
ABS & PVC BACKWATER VALVES	14
BACKWATER VALVE COMPONENTS	15
WASTE & OVERFLOW	18
ROOF FLASHINGS	19
ROOF DRAINS	22

SPECIALTY PLUMBING PRODUCTS

PRICE LIST USP-0215-IP FEBRUARY 9, 2015



Eliminate the hassle and expense of connecting drain fixtures to an external vent line

Ideal for:

- Island kitchen sinks
- Bathroom sinks
- Bar sinks
- Bath tubs
- Renovation projects



IPEX
PermOseal[®]

AAV

AIR ADMITTANCE VALVE

Allows air to enter the drainage system, while preventing sewer gases from escaping. The AAV only opens under negative pressure in the piping system, while remaining closed if there is positive or ambient air pressure - Eliminating the need for external venting!



1-1/2" & 2" For fixture and branch venting

DESC.	PART #	SKID QTY.	CTN. QTY.	SIZE	PRICE EACH
Air Admittance Valves					
	ABS				
	13112011		10	1-1/2 & 2	35.32
	PVC				
	13212011		10	1-1/2 & 2	35.32

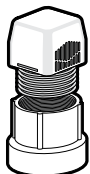

SPECIALTY PLUMBING PRODUCTS

PRICE LIST USP-0215-IP FEBRUARY 9, 2015

SPECIALTY FLANGE REPAIR RINGS

U.S. Patent: 6,416,084 B

► Installation instructions

1. Remove the damaged closet flange ring.
2. Slide the protruding lip on the interior edge of the Repair Ring into the grooved channel of the flange body, lay the ring flat on the floor, then rotate the ring until the closet bolt slots are in the desired position.
3. Using a screwdriver, bend the Repair Ring "claws" into the grooved channel of the closet flange body to clamp it in place.
4. Insert the toilet bolts in the closet bolt slots.
5. Fasten screws to the floor through the holes located on the ring and on the "claws". Re-install toilet.

DESC.	PART #	SKID QTY.	CTN. QTY.	SIZE	PRICE EACH
STAINLESS STEEL CLOSET FLANGE REPAIR RING					
	133608		15	4" x 3"	25.33

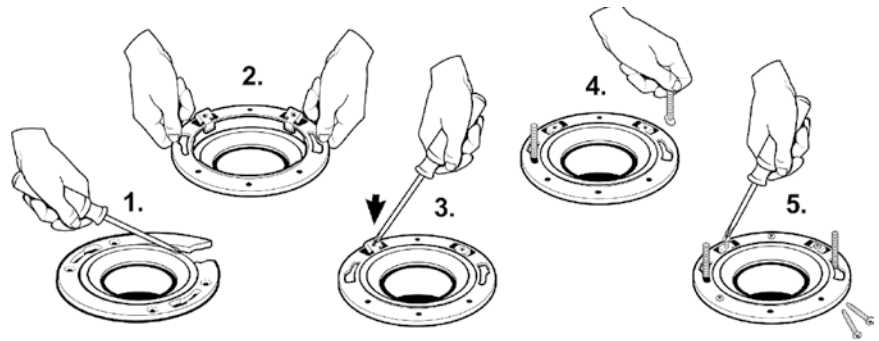
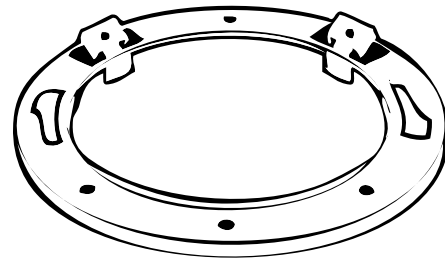

VENT PIPE CAP



► Material

- Injection molded in Plastic

► Function

- Prevents debris from entering vent pipes without obstructing air flow

► Features & benefits

- Interior supports accommodate either 3" or 4" pipe in a variety of materials (ABS DWV, PVC DWV and PVC sewer) (No double stocking)
- Cap is secured to vent pipe by utilizing two self-tapping screws. (Reduces chance of unauthorized removal)
- Installation screws are recessed into the cap (Eliminating a possible hazard due to protruding screws)
- Colors are designed to match those of the pipe (white and green) for a professional appearance
- Stainless steel installation screws are secured into the cap, prior to shipping (prevents accidental loss or replacement).

DESC.	PART #	SKID QTY.	CTN. QTY.	SIZE	PRICE EACH
VENT PIPE CAP					
	133070GN		15	3" and 4"	10.59
	133070W		15	3" and 4"	10.59

SPECIALTY PLUMBING PRODUCTS

PRICE LIST USP-0215-IP FEBRUARY 9, 2015

DESC.	PART #	SKID QTY.	CTN. QTY.	SIZE	PRICE EACH
-------	--------	-----------	-----------	------	------------

CLOSET FLANGES

45° DISCHARGE CLOSET FLANGE - Hub



ABS (with adjustable plastic ring)					
113628	640	20	4 x 3		15.39
ABS (with adjustable stainless steel ring)					
113628SS	640	20	4 x 3		15.39
PVC (with adjustable plastic ring)					
213628W	640	20	4 x 3		16.25
PVC (with adjustable metal ring)					
213628MW	640	20	4 x 3		16.25
PVC (with adjustable stainless steel ring)					
213628WSS	640	20	4 x 3		16.25

OFFSET CLOSET FLANGE - Hub (Offset 1/2")



PVC (with adjustable stainless steel ring)					
213639WSS	600	25	3, 4		23.19

OFFSET CLOSET FLANGE - One-piece



ABS					
113645		20	3, 4		7.72

CLOSET FLANGE SPACER RING WITH 4 HOLES



ABS					
119180-002	3600	25	4		3.66
PVC					
219180-002W	3600	25	4		3.86

CLOSET FLANGE, One Piece Plastic - Hub - Flush Kit



PVC (without pipe stop) Fits over 3" DWV, Inside 4" DWV					
213631XW	800	25	4 x 3		6.88

CLOSET FLANGE, With Molded Test Plate



PVC Fits over 3" DWV, Inside 4" DWV					
213631TW	800	25	4 x 3		7.66

DESC.	PART #	SKID QTY.	CTN. QTY.	SIZE	PRICE EACH
-------	--------	-----------	-----------	------	------------

CLOSET FLANGE, Adjustable, Hub-Flush Fit



ABS (without pipe stop) - Metal Adjustable Ring					
113627XSS	800	25	4 x 3		8.28
PVC (without pipe stop) - Stainless Steel Adjustable Ring					
213627XWSS	800	25	4 x 3		8.30

ADAPTER Only for Closet Flange Kit for Concrete H x Spg

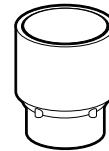

ABS					
113650-1	576	12	4 x 3		16.11

New!



IPEX EO

**No Hammer-
Easy Open
Test Cap Closet Flanges**

Tested to 15 PSI



• No more hammers
• No more damage!

Innovative test membrane from IPEX enables mess-free removal of the test membrane after a water test.

Simply remove the membrane with a knife after the system is tested.
• Patent Pending

PART #	SIZE	SKID QTY.	CTN. QTY.	PRICE
ABS (with pipe stop, one-piece plastic)				
113631EO	4 x 3	800	25	4.76
ABS (without pipe stop, stainless steel ring)				
113627XSSEO	4 x 3	800	25	8.90
PVC (with pipe stop, one-piece plastic)				
213631WEO	4 x 3	800	25	4.76
PVC (without pipe stop, stainless steel ring)				
213627XWSSSEO	4 x 3	800	25	9.37

SPECIALTY PLUMBING PRODUCTS

PRICE LIST USP-0215-IP FEBRUARY 9, 2015

DESC.	PART #	SKID QTY.	CTN. QTY.	SIZE	PRICE EACH
-------	--------	-----------	-----------	------	------------



SHOWER DRAINS

GREAT WHITE® TILED SHOWER DRAIN

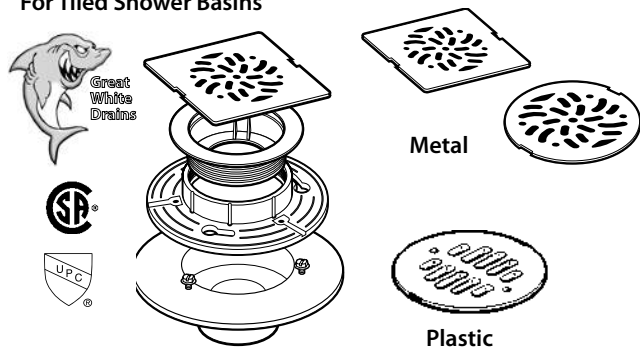
For Tiled Shower Basins





4" SQUARE GRATE DRAIN					
ABS with Stainless Steel Strainer					
	332342SS	480	10	2	24.41
PVC with Stainless Steel Strainer					
	322342WSS	480	10	2	24.41

ROUND GRATE DRAIN					
ABS with White Strainer					
	332242	480	10	2	15.79
PVC with White Strainer					
	322242W	480	10	2	15.79
ABS with Stainless Steel Strainer					
	332242SS	480	10	2	24.41
PVC with Stainless Steel Strainer					
	322242WSS	480	10	2	24.41

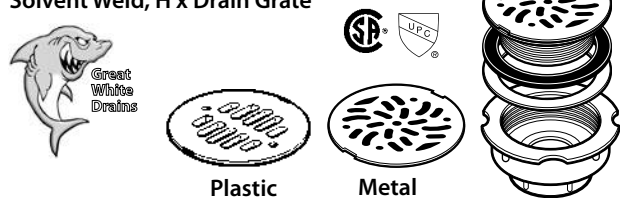
GREAT WHITE® SHOWER DRAIN WITH FEMALE THREADED BODY, Solvent Weld, H x Drain Grate





ROUND GRATE DRAIN					
ABS with White Strainer					
	332042	1800	25	2	12.92
PVC with White Strainer					
	322042W	1800	25	2	12.92
ABS with Stainless Steel Strainer					
	332042SS	1800	25	2	20.12
PVC with Stainless Steel Strainer					
	322042WSS	1800	25	2	20.12

DESC.	PART #	SKID QTY.	CTN. QTY.	SIZE	PRICE EACH
-------	--------	-----------	-----------	------	------------

GREAT WHITE® 45° OFFSET SHOWER DRAIN WITH FEMALE THREADED BODY

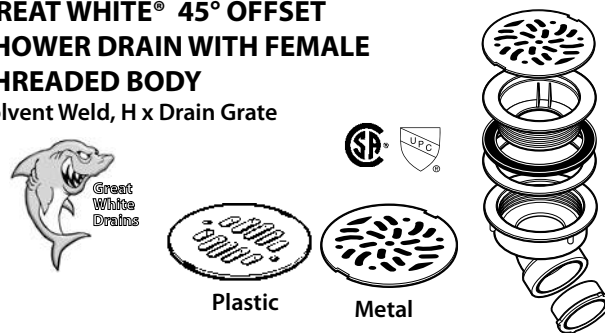
Solvent Weld, H x Drain Grate



ROUND GRATE DRAIN					
ABS with White Strainer					
	332542	1152	8	1½, 2	16.43
PVC with White Strainer					
	322542W	1152	8	1½, 2	16.43
ABS with Stainless Steel Strainer					
	332542SS	1152	8	1½, 2	21.82
PVC with Stainless Steel Strainer					
	322542WSS	1152	8	1½, 2	21.82

NOTE: Includes 2" x 1½" Flush Reducer Bushing

REPLACEMENT SNAP-IN STRAINER GRATE (FOR GREAT WHITE® SHOWER DRAINS)

Fits 1½" and 2" Shower Drains



SQUARE GRATE					
Stainless Steel					
	331943-2SS	160	-		6.19
Brushed Nickle Strainer					
	331943-2BN	160	-		16.86
Oil rubbed Bronze Strainer					
	331943-2ORB	160	-		17.81

ROUND GRATE					
White PVC Plastic					
	321942-2W	1	-		2.18
Stainless Steel					
	331942-2SS	160	-		5.75
	331952-1SS	1	FOR 331952SS		5.75
Brushed Nickle Strainer					
	331942-2BN	160	-		16.86
Oil rubbed Bronze Strainer					
	331942-2ORB	160	-		16.86

GREAT WHITE® DRAIN PRODUCTS
Designed and manufactured with innovative features for superior performance, quality and value above the competition.

SPECIALTY PLUMBING PRODUCTS

PRICE LIST USP-0215-IP **FEBRUARY 9, 2015**

DESC.	PART #	SKID QTY.	CTN. QTY.	SIZE	PRICE EACH
-------	--------	-----------	-----------	------	------------

SHOWER DRAINS Continued

ECONOMY SHOWER DRAIN with strainer, solvent weld H x drain grate



ABS					
331982SS		20	2		11.45
PVC (white)					
321982WSS		20	2		11.45



BRASS NO-CAULK SHOWER DRAIN with snap-in stainless steel strainer



331952SS		1	2		35.73
----------	--	---	---	--	-------



ECONOMY LOW-PROFILE BOLT-DOWN SHOWER DRAIN with stainless steel strainer

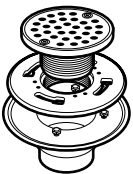

ABS					
331957SS		20	2		17.89
PVC (white)					
321957WSS		20	2		18.88



ECONOMY OFFSET SHOWER DRAIN with stainless steel strainer, solvent weld - H x drain grate

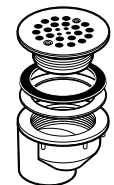

ABS					
331962SS		30	2		12.18

UTILITY DRAINS & CLEANOUTS

GENERAL PURPOSE DRAIN with 4" stainless steel strainer, solvent weld fits over 2" or 3" Schedule 40 DWV pipe



ABS					
331972SS		20	2, 3		7.69
PVC (white)					
321972WSS		20	2, 3		7.69

GENERAL PURPOSE DRAIN with 5" stainless steel strainer, solvent weld fits over 3" or 4" Schedule 40 DWV pipe



ABS					
332147SS		10	3, 4		11.22

DESC.	PART #	SKID QTY.	CTN. QTY.	SIZE	PRICE EACH
-------	--------	-----------	-----------	------	------------

SNAP-IN CLEANOUT - Hub

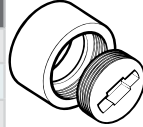

ABS					
333153		30	3, 4		11.99
PVC					
323152		30	2, 3		9.99

INSERT DRAIN GRATE Spg x Drain Grate

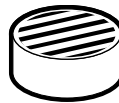

PVC					
213863W	3600	50	3 DWV		7.34
213864W	1800	25	4 DWV		7.65

PIPE END DRAIN GRATE



PVC (white)					
321842W	17150	50	2		3.24
321843W	7200	50	3		3.59
321844W	3600	25	4		5.02
PVC (grey)					
321842	17150	50	2		3.24
321843	7200	50	3		3.59
321844	3600	25	4		5.02

Consult your local plumbing official or plumbing code to confirm compliance.

PVC FLOOR DRAINS

ENDURA® FLOOR DRAIN - NEW Flame & Smoke Spead Rated



PVC Gray					
384750	96	2	3		73.55
384751	96	2	4		73.55

ENDURA® FLOOR COMPONENTS



Drain Strainer					
384750-2		1	5		5.47
Floor Drain Grate					
384750-3		1	5		8.66

SPECIALTY PLUMBING PRODUCTS

PRICE LIST USP-0215-IP FEBRUARY 9, 2015

DESC.	PART #	SKID QTY.	CTN. QTY.	SIZE	PRICE EACH
-------	--------	-----------	-----------	------	------------

FLOOR SINKS

STANDARD FLOOR (PVC-white body)



4" Hub					
394708	90	5	9 x 9 x 6	SEE U39 PRICE LIST	
4" Hub					
394713	90	5	12 x 12 x 6	SEE U39 PRICE LIST	
3" Hub					
394718	90	5	9 x 9 x 6	SEE U39 PRICE LIST	
3" Hub					
394723	90	5	12 x 12 x 6	SEE U39 PRICE LIST	

SINK GRATES (PVC White)

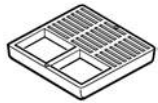
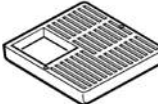
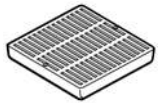

Full Grate					
394709A	420	5	9 x 9	SEE U39 PRICE LIST	
394712A	240	5	12 x 12	SEE U39 PRICE LIST	
Three Quarters Grate					
394709B	625	5	9 x 9	SEE U39 PRICE LIST	
394712B	240	5	12 x 12	SEE U39 PRICE LIST	
Half Grate					
394709C	625	5	9 x 9	SEE U39 PRICE LIST	
394712C	240	5	12 x 12	SEE U39 PRICE LIST	

FLOOR SINK REPLACEMENT STRAINER



394712-4	0	5	SEE U39 PRICE LIST	
----------	---	---	--------------------	--

FLOOR SINK REPLACEMENT HARDWARE KIT

Kit Number	For Drains	Includes	List Price
3947NNH	324708	#10-16 x 1-1/2" Long Flat Head Screw (2) #10 x 5/8" Long Hex/Phillips Screw (12)	SEE U39 PRICE LIST
	324709		
	324712		
	324713		

DESC.	PART #	SKID QTY.	CTN. QTY.	SIZE	PRICE EACH
-------	--------	-----------	-----------	------	------------

BELL TRAP DRAINS



BELL TRAP DRAIN SQUARE 6" - fits over 1 1/2" or into 2" hub connection - solvent weld

ABS					
332155		10	1 1/2, 2 Spg		10.04
PVC (white)					
322155W		10	1 1/2, 2 Spg		9.52



BELL TRAP DRAIN SQUARE 9" - fits over 3" or into 4" Schedule 40 DWV pipe - solvent weld

ABS					
332158		10	3, 4		25.47
PVC (white)					
322158W		10	3, 4		22.85

CLEANOUT PLUGS

BRASS RECESSED HEAD CLEANOUT PLUGS - MPT



333063BR		50	3		7.41
333067BR		50	3 1/2		8.79
333064BR		50	4		10.95
333068BR		10	6		31.39

BRASS RAISED HEAD CLEANOUT PLUGS - MPT

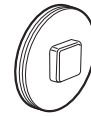

333053BR		50	3		6.80
333056BR		50	3 1/2		8.12
333054BR		50	4		11.94
333058BR		10	6		30.31

PLASTIC RECESSED HEAD CLEANOUT PLUGS - MPT



113061BL	8820	20	1 1/2		2.27
113062BL	8820	20	2		2.49
113063BL	3500	20	3		3.60
113065BL	3500	20	2 1/2		2.72
113067BL	2500	20	3 1/2		4.93
113068BL	2500	20	4 1/2		5.85
113069BL	1250	10	5 1/2		11.58

SPECIALTY PLUMBING PRODUCTS

PRICE LIST USP-0215-IP FEBRUARY 9, 2015

DESC.	PART #	SKID QTY.	CTN. QTY.	SIZE	PRICE EACH
-------	--------	-----------	-----------	------	------------

CAST COVERALL CLEANOUTS

IPS SPUDS with 6" Round Cover & Ring



PVC - Nickle Bronze					
323502WCRNB		4	3, 4		87.40
PVC - Brass					
323502WCRPB		4	3, 4		87.40

IPS PLASTIC SPUDS with 6" Round Strainer & Ring



PVC - Nickle Bronze					
323502WNBM		4	3, 4		84.36
PVC - Brass					
323502WPBM		4	3, 4		84.36

Visit our website for more information

- Specification Sheets
- E-Newsletter
- Price Lists



www.ipexamerica.com

DESC.	PART #	SKID QTY.	CTN. QTY.	SIZE	PRICE EACH
-------	--------	-----------	-----------	------	------------

ADAPTERS

90° TRAP ADAPTER, H x Slip Joint , Ideal for Pedestal Sinks



ABS					
112286A	3600	50	1½ x 1¼		3.93
112281A	3600	50	1½ x 1½		3.93
PVC					
212286AW	3600	50	1½ x 1¼		4.15
212281AW	3600	50	1½ x 1½		4.15

90° SINK STRAINER ADAPTER, H x Strainer Adapters (with gasket)



ABS					
112291A	3600	50	1½		3.93
PVC					
212291AW	3600	50	1½		4.15

SANITARY TEE TRAP ADAPTER, H x H x Slip Joint



ABS					
112171A	1600	50	1½		4.63
PVC					
212171AW	1600	50	1½		4.89

SANITARY TEE SINK STRAINER ADAPTER, H x H x Strainer Adapter (with gasket)



ABS					
112191A	1600	50	1½		4.63
PVC					
212191AW	1600	50	1½		4.89

SINK STRAINER ADAPTER

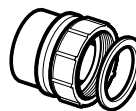

ABS					
103215	640	20	1½		SEE U10 PRICE LIST
PVC					
213215W	8640	60	1½		4.18

P-TRAP PRIMER PORT, Spg x Spg x FPT



PVC					
212110-1W	1440	20	3 x 3 x ½		9.29

PVC CAST IRON ADAPTER (Adapts PVC pipe to Cast Iron threaded connections) Hub x NPT



PVC					
213467W	1200	25	3 x 3½		21.97

SPECIALTY PLUMBING PRODUCTS

PRICE LIST USP-0215-IP FEBRUARY 9, 2015



IPEX Appliance Fittings



DESC.	PART #	SKID QTY.	CTN. QTY.	SIZE	PRICE EACH
-------	--------	-----------	-----------	------	------------

APPLIANCE ADAPTER, Spg x Hose Barb

ABS					
	112320		80	1½ x 1½	7.34

The most extensive range of appliance fittings in the industry; giving you flexibility of installation for connecting appliances such as dishwashers and condensate lines.

APPLIANCE WYE, H x H x Hose Barb Snap-in Plug is Molded on Fitting for Use During "Rough-In"

ABS					
	112321	2880	40	1½ x 1½ x 1½	2.95
	112332	2880	40	1½ x 1½ x ¾	2.95
	112333	2880	40	1½ x 1½ x 1	2.95
PVC					
	212321W	2880	40	1½ x 1½ x 1½	3.11
	212332W	2880	40	1½ x 1½ x ¾	3.11
	212333W	2880	40	1½ x 1½ x 1	7.73

Termination screen

To prevent foreign objects from entering a venting system and causing an obstruction. Obstructions can reduce efficiencies or cause the furnace/ water heater to shutdown.

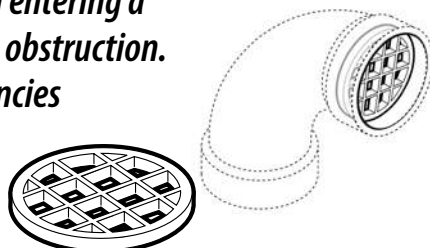

TERMINATION SCREEN, Polypropylene

BLACK - Push fit to fitting hub					
	112002	17150	50	2	2.52
	112003	14400	100	3	4.12
WHITE - Push fit to fitting hub					
	112002W	22050	50	2	2.52
	112003W	14400	100	3	4.12
	112004W		70	4	6.98

SPECIALTY PLUMBING PRODUCTS

PRICE LIST USP-0215-IP FEBRUARY 9, 2015

DESC.	PART #	SKID QTY.	CTN. QTY.	SIZE	PRICE EACH
-------	--------	-----------	-----------	------	------------

EXPANSION JOINTS

Allows for the expansion and contraction of pipe due to temperature change and the shrinkage of building materials that the pipe is connected to.

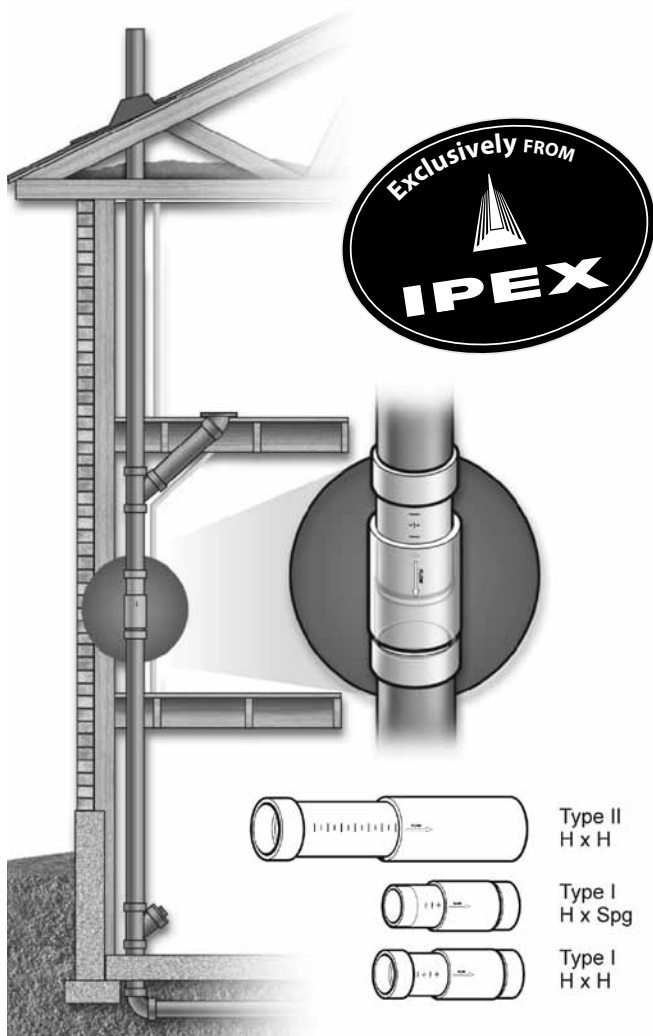

Installation Instructions

1. Locate unit (plunger side up). Preferably beneath lowest fixture.
2. Push plunger (inner section) until unit is fully closed.
3. Pull plunger back out specified distance according to temperature at time of installation.

Fahrenheit Degrees	Celsius Degrees	Distance
30	0	2.5" or 65mm
50	10	2.25" or 55mm
70	20	2" or 50 mm
85	30	1.75" or 45mm

Based on 20 feet (6 meters) installation.

DESC.	PART #	SKID QTY.	CTN. QTY.	SIZE	PRICE EACH
-------	--------	-----------	-----------	------	------------

EXPANSION JOINT - H x H



ABS TYPE I - 3" Travel					
113811ABC	1728	12	1 1/2		21.18
113812ABC	1080	15	2		42.00
113813ABC	480	15	3		46.02
PVC TYPE I - 3" Travel					
213811AWBC	1728	12	1 1/2		19.80
213812AWBC	1080	15	2		77.58
213813AWBC	480	15	3		95.59
ABS TYPE II - 8" Travel					
113814ABC	128	4	4		107.51
PVC TYPE II - 8" Travel					
213814AWBC	128	4	4		208.53

EXPANSION JOINT - H x Spg End Piston



ABS TYPE I - 3" Travel					
113811BBC	1728	12	1 1/2		21.18
113812BBC	1080	15	2		42.00
113813BBC	480	15	3		46.02

Expansion Joints

- Injected molded in ABS (Black) and PVC (White).
- Nitrile Buna-N O-ring.
- PQAA Grease #2 lubricant.

Features

- Allows for up to 3" (7.6 cm) of travel (Type I) or 8" (20.3 cm) of travel (Type II).
- Flow direction and proper degree of extension indicated on expansion joint.
- Approved for use in vertical applications.

Benefits

- Allows movement without leakage.
- Removes the stress from both pipe and fittings which could cause failure of the piping system.

Applications

- For Drain, Waste & Vent applications (non-pressure).
- For Log Homes.
- For straight pipe runs of 30 ft. (9.1 m) or longer.

Approvals

- CSA Certified, IAPMO Listed

SPECIALTY PLUMBING PRODUCTS

PRICE LIST USP-0215-IP FEBRUARY 9, 2015



Used to provide a seal between 2" internally trapped urinals and drainage system.



IPEX

Urinal Flange Kits

- Flanges are made of corrosion resistant ABS and PVC plastic. They will not rot out like traditional urinal flanges providing longer life and fewer health concerns.
- 2" connections available in Hub and Spigot versions making IPEX urinal flange kits adaptable to a variety of systems.
- Complete with all the necessary mounting hardware eliminating missing or back-ordered parts.
- Adjustable 4" - 7" center which can be cut easily to accommodate the requirements of most applications.
- The flange is reinforced with a cross rib to prevent the fork from spreading.
- Thick foam gasket provides a positive seal, reducing the potential for leaks.

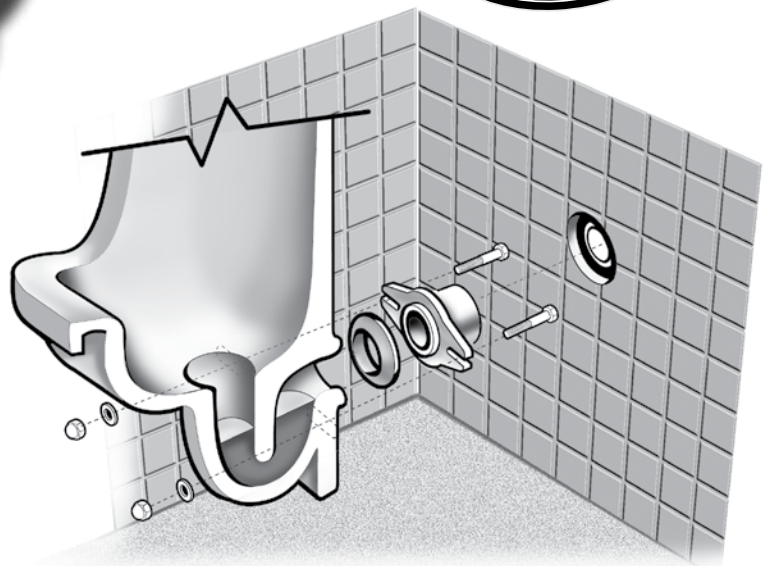

DESC.	PART #	SKID QTY.	CTN. QTY.	SIZE	PRICE EACH
-------	--------	-----------	-----------	------	------------

URINAL FLANGE KIT

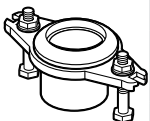

ABS - Spigot					
113660††	1200	25	2		20.92
113661‡‡	1440	20	2		22.99

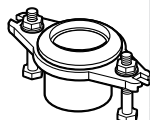

ABS - Hub					
113662††	1200	25	2		20.92
113663‡‡	1440	20	2		22.99

PVC - Spigot					
213660W††	1200	25	2		22.08
213661W‡‡	1440	20	2		24.25

PVC - Hub					
213663W‡‡	1440	20	2		24.25

†† with 4" Center ‡‡ with Adjustable Center: 4" - 7"

SPECIALTY PLUMBING PRODUCTS

PRICE LIST USP-0215-IP **FEBRUARY 9, 2015**



DESC.	PART #	SKID QTY.	CTN. QTY.	SIZE	PRICE EACH
-------	--------	-----------	-----------	------	------------

PERMOSEAL® 4" X 3" REDUCING LINE CLEANOUT with Test Membrane

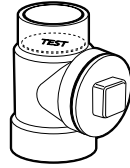

ABS					
112107AT	270	15	4 x 3 x 4		28.13
PVC					
212107WAT		15	4 x 3 x 4		28.13

REDUCING LINE CLEANOUT WITH TEST MEMBRANE

- No more glued in test plates
- No more mechanical test plugs or test balls

Innovative test membrane from IPEX enables mess-free removal of the test membrane after a water test.

By puncturing the PVC membrane with a utility knife, wastewater is drained slowly, avoiding the typical torrent of wastewater mess with other test methods.

Simply remove the membrane with a knife after the system is fully drained.

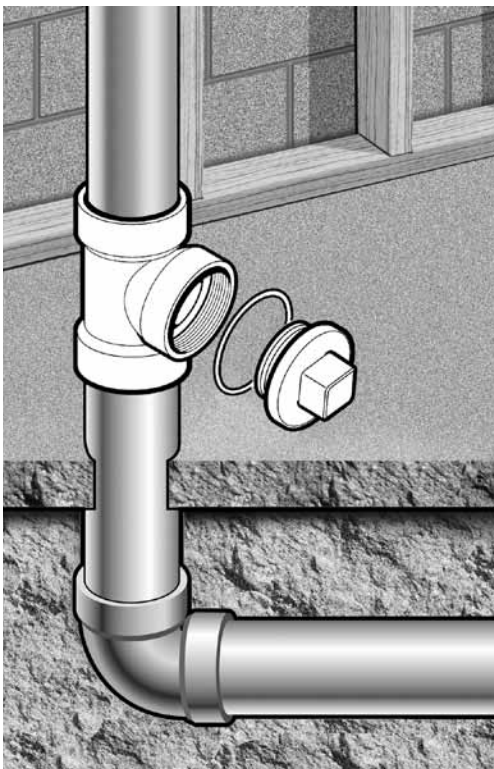

GASKETED LINE CLEANOUTS

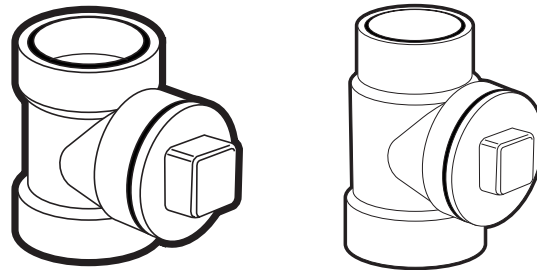

LINE CLEANOUTS WITH O-RING ON PLUG

PVC					
212114AW	2160	30	1½		11.55
212115AW	1440	20	2		13.00
212116AW	480	15	3		20.00
212117AW	240	10	4		29.13
PVC - Reducing line cleanout					
212107A	270	15	4 x 3		25.07

SPECIALTY PLUMBING PRODUCTS

PRICE LIST USP-0215-IP FEBRUARY 9, 2015

DESC.	PART #	SKID QTY.	CTN. QTY.	SIZE	PRICE EACH
-------	--------	-----------	-----------	------	------------

TEST TEES

MAINLINE TEST TEE - ABS



123267*		24		37.75
---------	--	----	--	-------

MAINLINE TEST GATE



123267TG*		24		7.35
-----------	--	----	--	------

MAINLINE TEST SPACER GATE



123267SG*		24		7.46
-----------	--	----	--	------

* All components must be ordered to have a complete unit

BACKWATER VALVES

BACKWATER VALVE



ABS - With DWV Hubs					
123281	1080	15	1½		35.75
123282	1080	15	2		35.75
123283	320	10	3		42.29
123284	128	4	4		48.25
123286	48	1	6		178.71
PVC (white) - With DWV Hubs					
223281W	1080	15	1½		35.75
223282W	1080	15	2		35.75
223283W	320	10	3		42.29
223284W	128	4	4		48.25
223286W	48	1	6		178.71
PVC - With Sewer Hubs					
223291W	288	4	3		45.27
223289W	144	2	4		53.62

6 BACKWATER VALVE SLEEVE LID



PVC					
223286-6W		15	6		34.32

DESC.	PART #	SKID QTY.	CTN. QTY.	SIZE	PRICE EACH
-------	--------	-----------	-----------	------	------------

BACKWATER VALVE with 16" access sleeve and ABS lid

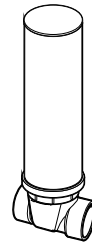

ABS - With DWV Hubs					
123271		1	1½		45.27
123272	144	1	2		45.27
123287	84	1	3		54.20
123285	45	1	4		69.71
PVC (white) - With DWV Hubs					
223271W		1	1½		45.27
223272W	128	1	2		45.27
223287W	84	1	3		54.20
223285W	45	1	4		69.71
PVC (white) - With cast iron lid					
223287WSC	84	1	3		72.61
223285WSC	45	1	4		90.87
PVC (white) - With Sewer Hubs					
223290W	84	1	3		57.19
223288W	45	1	4		71.48

BACKWATER VALVE SLEEVE KIT - For use with Sewer Pipe (Standard, DR35 or DR28)



ABS					
123302	1440	10	For 1½" & 2" BWVs		15.01
PVC (white)					
223302W	1440	10	For 1½" & 2" BWVs		15.01

The chart below outlines the nominal diameter of sewer pipe required for the IPEX Backwater Valve Sleeve Kits:

Backwater Valve Hub Size	Sewer Pipe Diameter
1½"	4"
2"	4"
3"	6"
4"	8"
6"	10"

SPECIALTY PLUMBING PRODUCTS

PRICE LIST USP-0215-IP FEBRUARY 9, 2015

DESC.	PART #	SKID QTY.	CTN. QTY.	SIZE	PRICE EACH
-------	--------	-----------	-----------	------	------------

BACKWATER VALVES Continued

LID FOR ABS (BLACK) ACCESS SLEEVES



ABS Lid					
	123287-2		1	3	5.72
	123285-2		1	4	7.91

LID FOR SEWER PIPE ACCESS SLEEVES



ABS (black)					
	123302-2		100	1½ or 2	5.72
	123303-2		0	3	5.72
	123304-2		0	4	7.91
PVC (white)					
	223302-2W		30	1½ or 2	5.72
	223303-2W		20	3	5.72
	223304-2W		20	4	7.91
	223286-3W		1	6	34.65
Cast Iron Lid					
	123287-2C		1	3	19.32
	123285-2C		1	4	23.69

BACKWATER VALVE SLEEVE KIT for use with sewer pipe (Standard, DR35 or DR28)

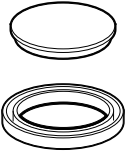

ABS					
	123303	1080	15	For 3" BWV	9.77
	123304	480	10	For 4" BWV	13.71
PVC					
	223303W	1080	15	For 3" BWV	9.77
	223304W	480	10	For 4" BWV	13.71
PVC BWV Sleeve Kit with cast iron lid					
	223303WC	1080	15	For 3" BWV	21.19

REPLACEMENT FLAPPERS FOR BACKWATER VALVES Comes complete with O-ring



Flapper with Gasket and Retaining Ring					
	123281-2A	16000	500	1½ & 2	8.62
Flapper with O-Ring					
	123283-2A	12960	90	3	5.24
	123284-2A	6480	90	4	7.16
	123286-2A		25	6	15.16

DESC.	PART #	SKID QTY.	CTN. QTY.	SIZE	PRICE EACH
-------	--------	-----------	-----------	------	------------

BACKWATER COMPONENTS

BACKWATER VALVE COMPONENTS

Flapper (ABS) with Gasket & Retaining Ring					
	123281-2A	16000	500	1½ & 2	8.62
Flapper (PVC) with Gasket & Retaining Ring					
	223281-2WA		500	1½ & 2	8.62
Cleanout Lid (ABS - Black) with O-ring					
	123281-3A		0	1½ & 2	7.25
Cleanout Lid (PVC - White) with O-ring					
	223281-3WA		125	1½ & 2	7.25
O-ring for Cleanout Lid					
	123281-4		1	1½ & 2	0.65
Lid for Sewer Pipe†† (Black) 4" pipe diameter					
	123302-2		100	1½ & 2	5.72
Lid for Sewer Pipe†† (White) 4" pipe diameter					
	223302-2W		30	1½ & 2	5.72
Flapper with O-ring					
	123283-2A	12960	90	3	5.24
O-ring for Flapper					
	123283-5		1	3	2.56
Cleanout Lid (ABS - Black) with O-ring					
	123283-3A	1600	50	3	9.71
Cleanout Lid (PVC - White) with O-ring					
	223283-3WA		50	3	9.71
O-ring for Cleanout Lid					
	123283-4		1	3	0.95
Access Sleeve‡‡ with 5" pipe diameter					
	123287-3		1	3	29.96
Sleeve Lid‡‡ with 5" pipe diameter					
	123287-2		1	3	5.72
Lid for Sewer Pipe†† (Black) with 6" pipe diameter					
	123303-2		0	3	5.72
Lid for Sewer Pipe†† (White) with 6" pipe diameter					
	223303-2W		20	3	5.72
Flapper with O-ring					
	123284-2A	6480	90	4	7.16
Cleanout Lid (ABS - Black) with O-ring					
	123284-3A	1120	35	4	16.48
Cleanout Lid (PVC - White) with O-ring					
	223284-3WA		35	4	16.48
Access Sleeve‡‡ with 7" pipe diameter					
	123285-3		1	4	41.71
Sleeve Lid‡‡ with 7" pipe diameter					
	123285-2		1	4	7.91

†† Sewer Pipe referenced above is Standard SDR35.
‡‡ IPEX access sleeves and sleeve lids require a special diameter pipe; they will not work with Standard SDR35 pipe.

SPECIALTY PLUMBING PRODUCTS

PRICE LIST USP-0215-IP FEBRUARY 9, 2015

What's keeping
this...



Sewer and/or
stormwater drain

IPEX
Backwater
Valve

out of this?



To home drain
connections



These simple devices offer effective protection against the backflow of sewage and stormwater into homes and businesses.

Backwater Valves

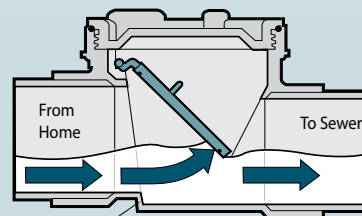

Built-in drainage slope

Under Normal Operation, the lightweight flapper opens and allows waste water to exit to sewer line.

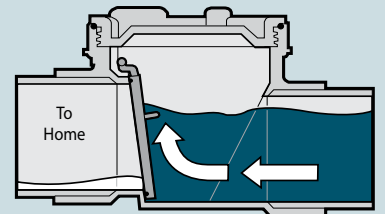

During a backflow, the flapper seals closed, stopping the flow from reaching interior drains entering the living space.

SPECIALTY PLUMBING PRODUCTS

PRICE LIST USP-0215-IP FEBRUARY 9, 2015



MAINLINE

EXTENDABLE *Straight-Fit* Backwater Valves

The Straight-Fit™ Backwater Valve features a patent pending flapper, designed to smoothly guide cleaning and surveying equipment through the BWV, also allowing for safe withdrawal of the same, minimizing risk of damage to the flapper. The addition of a Smart-Curve™ snake guide also prevents damage to the valve body during snaking from the main access.

The Straight-Fit™ Valve body design has minimal slope, making it ideal for new installations and retrofits.

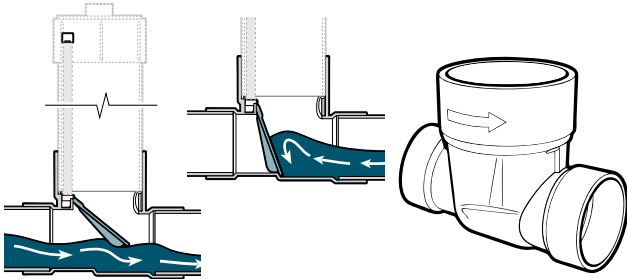

PART #	CTN. QTY.	SIZE	PRICE EACH
ABS - Straight-Fit			
123263ST	1	3	128.08
123264ST	6	4	169.33
123266ST	3	6	452.52
PVC - Straight-Fit			
223263WST	1	3	134.03
223264WST	6	4	169.33
223266WST	3	6	452.52

REPLACEMENT FLAPPERS			
123263ST-2A	1	3	53.58
123264ST-2A	1	4	53.62
123266ST-2A	1	6	61.31

Extendable Straight-Fit Test-Gate

Test gates can be used during pressure tests.

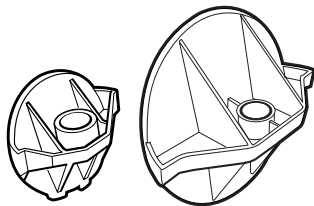

REPLACEMENT FLAPPERS			
123263STX	1	3	26.80
123264STX	1	4	24.53
123266STX	1	6	40.84

CLEAR INSPECTION COVER *FULLPORT* Backwater Valves

The Fullport BWV is designed to protect the entire home from hazardous sewage backflow. With a clear cover, you can be sure your backwater valve is operating properly. Designed to be installed as the last fitting on the outbound drain, this BWV can either be placed in a direct access location or recessed in-ground with the optional access box.

Once installed it becomes the first line of defense against costly and unsanitary backflow entering the property.

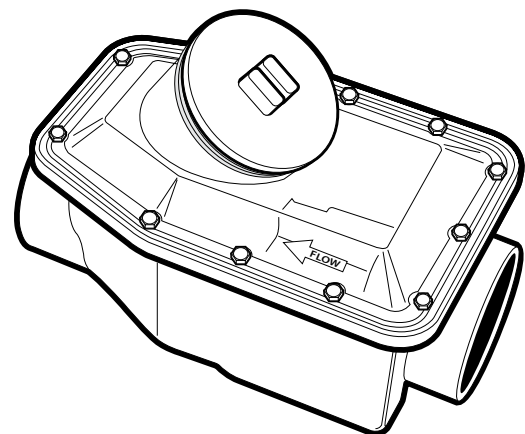
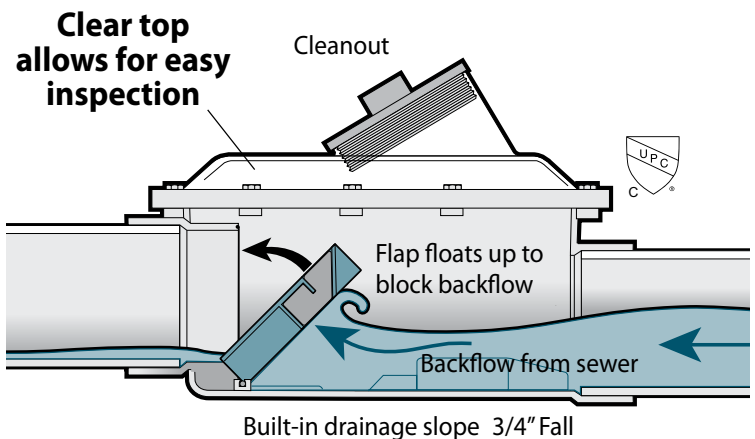

PART #	CTN. QTY.	SIZE	PRICE EACH
ABS - FULLPORT Backwater Valve			
123254	4	4	214.45
PVC - FULLPORT Backwater Valve			
223254W	4	4	235.31

4" DWV hub inlet & outlet connections

SPECIALTY PLUMBING PRODUCTS

PRICE LIST USP-0215-IP **FEBRUARY 9, 2015**

DESC.	PART #	SKID QTY.	CTN. QTY.	SIZE	PRICE EACH
-------	--------	-----------	-----------	------	------------

BACKWATER COMPONENTS Continued

BACKWATER VALVE COMPONENTS

Lid for Sewer Pipe†† (Black) 8" pipe diameter					
123304-2		0	4		7.91
Lid for Sewer Pipe†† (White) 8" pipe diameter					
223304-2W		20	4		7.91
Flapper with O-ring					
123286-2A		25	6		15.16
Cleanout Lid (ABS - Black) with O-ring					
123286-3A		0	6		40.58
Cleanout Lid (PVC - White) with O-ring					
223286-3WA		10	6		40.58
O-ring for Cleanout Lid					
123286-4		1	6		5.99
Lid for Sewer Pipe†† (White) with 10" pipe diameter					
223286-6W		15	6		34.32

WASTE & OVERFLOW

ABS WASTE & OVERFLOW HALF-KIT - Lift & Turn (coarse thread)



ABS (Chrome Lift-n-Turn Hardware)					
332925LCP		25	1½		24.26
ABS (Brush Nickel Trim Hardware)					
332925BN		25	1½		52.93
PVC (Brush Nickel Trim Hardware)					
322925WBN		25	1½		52.93

Kit includes trim hardware, waste & overflow elbows (less pipe & tee)

WASTE & OVERFLOW TEST KIT (RE-USABLE) For use with Half-Kits



332804TEST		200	-		6.73
------------	--	-----	---	--	------

LIFT-N-TURN TRIM KITS (COARSE THREAD) for Half-Kits

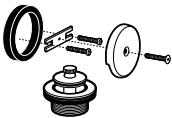

Chrome plated Lift-n-Turn hardware and overflow covers					
332925CPTRIM		20	Coarse Thread		18.67
Oil Rubbed Bronze Trim Hardware					
332925ORBTRIM		20	Coarse Thread		21.77
Brushed Nickel Trim Hardware					
332925BNTRIM		20	Coarse Thread		21.77

Kit includes strainer, hardware and overflow cover (less elbows)

PLEASE NOTE:

WASTE & OVERFLOW HALF-KITS INCLUDE COARSE THREAD TRIM HARDWARE WHICH ARE NOT INTERCHANGEABLE WITH GREAT WHITE® WASTE & OVERFLOW FINE THREAD HARDWARE

DESC.	PART #	SKID QTY.	CTN. QTY.	SIZE	PRICE EACH
-------	--------	-----------	-----------	------	------------

WASTE & OVERFLOW INDIRECT

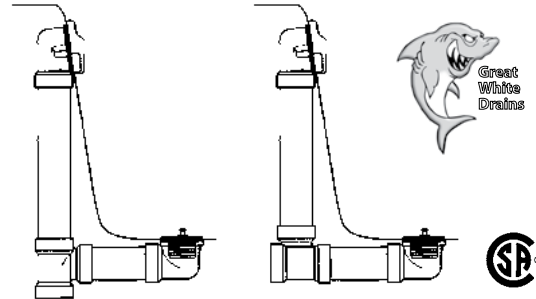

Indirect Bottom Outlet Configuration

Indirect Rear Outlet Configuration

ABS GREAT WHITE® INDIRECT KIT

Lift & Turn (Chrome Trim) without Pipe					
332806		800	25	1½	30.53

SPECIALTY PLUMBING PRODUCTS

PRICE LIST USP-0215-IP FEBRUARY 9, 2015

PermOseal® StretchFit

PIPE FLASHING



MODEL: 551222
1.5"-2"
Pipe Sizes

MODEL: 551224
3"-4"
Pipe Sizes

**StretchFit seal fits
1.5" - 2" and 3" - 4" vent pipe sizes**

The PermOseal® StretchFit requires no adjustment, no cutting and no tearing!

The new PermOseal® StretchFit flashing is a breakthrough in flashing seal technology.

- UV and Extreme Cold Resistant
- Built in water deflectors
- Fits roof pitches from 2/12 to 12/12
- Patent Pending

Available in Black, Brown, Gray, Green, White & Weatherwood

COLOR	PART #	CTN. QTY.	SKID QTY.	PRICE
Pipe Size 1.5" to 2" Flange Size 9¼" X 13"				
Black	551222BL**	12	576	9.76
Brown	551222BR**	12	576	9.76
Gray	551222G**	12	576	10.73
Weatherwood	551222WW**	12	576	10.73
Pipe Size 3" to 4" Flange Size 12" X 15½"				
Black	551224BL**	12	384	10.66
Brown	551224BR**	12	384	10.66
Gray	551224G**	12	384	11.73
Weatherwood	551224WW**	12	384	11.73

SPECIALTY PLUMBING PRODUCTS

PRICE LIST USP-0215-IP FEBRUARY 9, 2015



**3 Sizes
in 1!**

PermOseal®
Multiple 3 in 1

**Cut and Peel for
1.5" to 3" vent
pipe sizes**



& Peel

- UV and Extreme Cold Resistant
- Built in water deflectors
- Fits roof pitches from 2/12 to 12/12

COLOR	PART #	CTN. QTY.	SKID QTY.	PRICE
Pipe Size 1.5" to 3" Flange Size 12"X15"				
Black	551233BL*	12	384	6.32



Thermoplastic **Base
Flashing**

- Fits roof pitches from 2/12 – 12/12
- UV and Extreme Cold Resistant
- Water Deflectors

COLOR	PART #	CTN. QTY.	SKID QTY.	PRICE
Pipe Size 1.5" Flange Size 13" x 9 1/4"				
Black	551201BL**	12	576	6.68
Pipe Size 2" Flange Size 13" x 9 1/4"				
Black	551202BL**	12	576	6.87
Pipe Size 3" Flange Size 15" x 12"				
Black	551203BL**	12	384	6.96
Brown	551203BR**	12	384	6.96
Pipe Size 4" Flange Size 15 1/2" x 12"				
Black	551204BL**	12	384	7.19
Brown	551204BR**	12	384	7.19

SPECIALTY PLUMBING PRODUCTS

PRICE LIST USP-0215-IP FEBRUARY 9, 2015

ROOF FLASHINGS



PermOseal® **Flexible** BASE FLASHING

Newly engineered material stays flexible in extreme cold conditions

- Built in water deflectors
- Fits roof pitches from 2/12 to 12/12

COLOR	PART #	CTN. QTY.	SKID QTY.	PRICE
Pipe Size 1.5" Flange Size 13"X15"				
Black	551141BL**	12	384	15.79
Pipe Size 2" Flange Size 13"X15"				
Black	551142BL**	12	384	15.79
Pipe Size 3" Flange Size 16 1/4" X 18"				
Black	551143BL**	12	192	15.79
Pipe Size 4" Flange Size 16 1/4" X 18"				
Black	551144BL**	12	192	15.79

Steep Roof Flashing



Works on pitches up to 20/12 (60°)

- Patented one-piece design
- Easy installation with thermoplastic base
- 2/12 (10°) up to 20/12 (60°)
- Tear away ring sizing for different pipe sizes
- Double seal, No-Calk® water tight collar

COLOR	PART #	CTN. QTY.	SKID QTY.	PRICE
Pipe Size 1.5" - 3" Flange Size 11 1/4" x 19"				
Black	5511930	6	180	24.02
Pipe Size 3" - 4" Flange Size 13" x 20 1/8"				
Black	5511931	6	180	24.02

O-Guard™ Roof Flashing Seal Protector



Protection from harmful UV rays and weather conditions

- Easy installation - simply slide down pipe over flashing
- Does not reduce pipe size
- Unique innovation protects the seal

COLOR	PART #	CTN. QTY.	SKID QTY.	PRICE
Pipe Size 3"				
Black	5503	12	960	4.79

SPECIALTY PLUMBING PRODUCTS

PRICE LIST USP-0215-IP FEBRUARY 9, 2015

DESC.	PART #	SKID QTY.	CTN. QTY.	SIZE	PRICE EACH
-------	--------	-----------	-----------	------	------------

EXHAUST VENTS

BATHROOM EXHAUST VENT with flapper and attached collar

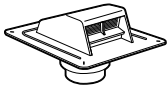

6011BL	108	6	Black	16.04
6011BR	108	6	Brown	16.04
6011G	108	6	Grey	17.64
6011WW	108	6	Weatherwood	17.64

BATHROOM EXHAUST VENT with flapper and unattached collar



6010BL	192	4	Black	15.11
6010BR	192	4	Brown	15.11
6010G	192	4	Grey	16.62

BATHROOM EXHAUST VENT with flapper



6008BL	192	4	Black	11.42
6008BR	192	4	Brown	11.42
6008G	192	4	Grey	12.56
6008WW	192	4	Weatherwood	12.56

ROOF DRYER VENT with flapper



6012BL	192	4	Black	11.42
6012BR	192	4	Brown	11.42

ROOF DRYER VENT with flapper and attached collar



6013BL	108	6	Black	16.04
6013BR	108	6	Brown	16.04
6013WW	108	6	Weatherwood	17.64

BATHROOM EXHAUST & ROOF DRYER VENT ADAPTER COLLAR



6010-1BC	576	8	Black	4.03
----------	-----	---	-------	------

DESC.	PART #	SKID QTY.	CTN. QTY.	SIZE	PRICE EACH
-------	--------	-----------	-----------	------	------------

ROOF DRAINS

ROOF DRAIN - NEW Flame & Smoke Speed Rated



Body Dome - PVC Gray

383552	90	5	2 Hub	71.48
383553	90	5	3 Hub	71.48
383554	90	5	4 Hub	79.43

ROOF DRAIN - NEW Flame & Smoke Speed Rated



Body Dome - PVC Gray

383556	36	2	6 Spg	101.78
383558	36	2	8 Spg	119.06

UNDER DECK CLAMP

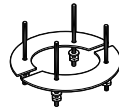

Enamel-coated clamp collar, 6" long studs, washer and nuts

383555	625	5	Drain Size 2, 3, 4	41.31
383557	360	5	Drain Size 6, 8	67.66

DOMESTRAINER



PVC - Gray

383552-3		1	Drain Size 2, 3, 4	20.17
----------	--	---	--------------------	-------

DOMESTRAINER



PVC - Gray

383556-3		1	Drain Size 6, 8	21.01
----------	--	---	-----------------	-------

FLASHING COLLAR



PVC - Gray

383552-2		1	Drain Size 2, 3, 4	13.29
383556-2		1	Drain Size 6, 8	18.26

ROOF DRAIN REPLACEMENT HARDWARE KIT for drains 383552, 383553, 383554, 383556, 383558

Kit Number	Includes	List Price
38355NH	2 of #10 x 1-1/2" Grate Screws and 12 of #10 x 5/8" Flange Screws	8.74

SPECIALTY PLUMBING PRODUCTS

NUMERICAL INDEX

PART NO.	WEIGHT (Lbs.)	CARTON BAR CODE	LOCATION IN PRICE LIST	PART NO.	WEIGHT (Lbs.)	CARTON BAR CODE	LOCATION IN PRICE LIST
P/L 11				123303-2	0.249	90662671120680	15
112002	0.015	10662671110173	10	123304	0.952	10662671120356	15
112002W	0.015	10662671117578	10	123304-2	0.459	10662671120677	15
112003	0.035	10662671110272	10	P/L 13			
112003W	0.035	10662671117585	10	133070GN	0.525	10662671130232	4
112004W	0.046	10662671057454	10	133070W	0.295	10662671130249	4
112107AT	1.656	10662671117127	10	133608	0.816	10662671130027	4
112171A	0.269	10662671113501	9	13112011	0.306	10662671117158	3
112191A	0.256	10662671113556	9	13212011	0.346	10662671214185	3
112281A	0.154	10662671110586	9	P/L 21			
112286A	0.143	10662671100594	9	212107A	2.218	10662671214161	13
112291A	0.139	10662671113549	9	212107WAT	2.220	10662671214260	13
112320	0.057	10662671110234	10	212110-1W	0.507	10662671210026	9
112321	0.148	10662671103304	10	212114AW	0.335	10662671214208	13
112332	0.161	10662671103465	10	212115AW	0.529	10662671214215	13
112333	0.168	10662671116700	10	212116AW	1.323	10662671214222	13
113061BL	0.035	10662671110517	8	212117AW	2.346	10662671214239	13
113062BL	0.037	10662671110524	8	212171AW	0.368	10662671210095	9
113063BL	0.073	10662671110531	8	212191AW	0.346	10662671210101	9
113062BL	0.037	10662671110524	8	212281AW	0.207	10662671210163	9
113067BL	0.097	10662671110555	8	212286AW	0.192	10662671210170	9
113068BL	0.154	10662671110562	8	212291AW	0.187	10662671210187	9
113069BL	0.278	10662671110579	8	212321W	0.203	10662671210194	10
113627XSSEO	0.697	10662671009644	5	212332W	0.218	10662671210200	10
113627XSS	0.694	10662671057164	5	212333W	0.229	10662671214154	10
113628	0.659	10662671103311	5	213215W	0.104	10662671214383	9
113628SS	0.884	10662671119152	5	213467W	0.551	10662671210057	9
113631EO	0.551	10662671057430	5	213627XWSS	0.805	10662671214369	5
113645	0.657	10662671110470	5	213627XWSSEO	0.807	10662671012002	5
113650-1	0.694	10662671119015	5	213628MW	1.043	10662671210491	5
113660	0.500	10662671118759	12	213628W	0.899	10662671210507	5
113661	0.525	10662671118766	12	213628WSS	0.888	10662671210996	5
113662	0.461	10662671110104	12	213631TW	0.747	10662671214123	5
113663	0.481	10662671119213	12	213631XW	0.728	10662671214147	5
113811ABC	0.492	50662671102961	10	213631WEO	0.785	10662671057447	5
113811BBC	0.487	50662671102978	10	213639WSS	1.197	10662671214178	5
113812ABC	0.639	50662671102985	10	213660W	0.558	10662671212891	12
113812BBC	0.595	50662671102992	10	213661W	0.586	10662671212907	12
113813ABC	1.367	60662671103002	10	213811AWBC	0.659	30662671190575	10
113813BBC	1.404	60662671103019	10	213812AWBC	0.807	30662671190599	10
113814ABC	3.695	50662671103333	10	213813AWBC	1.883	30662671190612	10
119180-002	0.227	10662671113532	5	213814AWBC	4.921	30662671190636	10
P/L 12				213863W	0.324	10662671214246	7
123254	5.997	10662671120929	17	213864W	0.529	10662671214253	7
123263ST	1.601	10662671066494	17	219180-002W	0.304	10662671210682	5
123263STX	0.099	10662671066500	17	P/L 22			
123263ST-2A	0.099	10662671066487	17	223254W	7.011	10662671220643	17
123264ST	3.221	10662671063219	17	223271W	1.612	10662671220223	14
123264STX	0.201	10662671066463	17	223272W	1.495	10662671220230	14
123264ST-2A	0.201	10662671066449	17	223281-2WA	0.068	10662671220278	15
123266ST	6.426	10662671063202	17	223281-3WA	0.194	10662671220384	15
123266STX	0.500	10662671066470	17	223281W	0.646	10662671220018	14
123266ST-2A	0.300	10662671066456	17	223282W	0.653	10662671220025	14
123267	1.499	10662671058895	14	223283-3WA	0.406	10662671220391	15
123267TG	0.201	10662671058901	14	223283W	1.810	10662671220032	14
123267SG	0.201	10662671058918	14	223284-3WA	0.926	10662671220407	15
123271	1.027	10662671120370	14	223284W	3.536	10662671220056	14
123272	1.226	10662671120387	14	223285W	4.916	10662671220070	14
123281	0.450	10662671120011	14	223285WSC	9.577	10662671220490	14
123281-2A	0.057	10662671120400	15	223286-3WA	2.011	10662671220377	18
123281-3A	0.150	10662671120615	15	223286-6W	1.680	10662671220155	14
123281-4	0.002	662671120625	15	223286W	9.361	10662671220162	14
123282	0.494	10662671120028	14	223287W	3.514	10662671220094	14
123283	1.362	10662671120035	14	223287WSC	6.715	10662671220483	14
123283-2A	0.064	10662671120417	15	223288W	5.300	10662671220117	14
123283-3A	0.293	10662671120608	15	223289W	3.918	10662671220124	14
123283-4	0.009	662671120632	15	223290W	3.757	10662671220179	14
123283-5	0.007	662671120694	15	223291W	2.050	10662671220186	14
123284	2.562	10662671120066	14	223264WST	4.299	10662671063233	PB
123284-2A	0.115	10662671120424	15	223266WST	8.770	10662671063226	PB
123284-3A	0.642	10662671120592	15	223302-2W	0.152	10662671220414	15
123285	4.021	10662671120097	14	223302W	0.708	10662671220216	14
123285-2	0.353	10662671120523	15	223303-2W	0.344	10662671220261	15
123285-2C	3.858	10662671120783	15	223303W	0.650	10662671220193	15
123285-3	1.030	10662671120530	15	223303WC	2.842	10662671220506	15
123286	6.964	10662671120196	14	223304-2W	0.650	10662671220247	15
123286-2A	0.688	10662671120431	15	223304W	1.299	10662671220209	15
123286-3A	1.455	90662671120659	18				
123286-4	0.022	662671120663	18				
123287	3.064	10662671120103	14				
123287-2	0.192	10662671120332	15				
123287-3	0.686	10662671065893	15				
123302	0.518	10662671120363	14				
123302-2	0.106	10662671120394	15				
123303	0.481	10662671120349	15				

SPECIALTY PLUMBING PRODUCTS

PART NO.	WEIGHT (Lbs.)	CARTON BAR CODE	LOCATION IN PRICE LIST	PART NO.	WEIGHT (Lbs.)	CARTON BAR CODE	LOCATION IN PRICE LIST
P/L 32				P/L 39			
321842	0.040	10662671320367	7	394708	3.660	10662671052701	7
321842W	0.042	10662671320268	7	394709A	2.105	10662671052916	7
321843	0.066	10662671320374	7	394709B	2.249	10662671052923	7
321843W	0.066	10662671320206	7	394709C	2.249	10662671052930	7
321844	0.137	10662671320381	7	394712A	3.790	10662671052961	7
321844W	0.143	10662671320213	7	394712B	3.790	10662671052497	7
321942-2W	0.084	662671320056	6	394712C	3.790	10662671052503	7
321957WSS	0.992	10662671320671	7	394713	4.583	10662671052978	7
321972WSS	0.481	10662671320688	7	394718	4.191	10662671052992	7
321982WSS	0.661	10662671320794	7	394723	5.113	10662671053029	7
322042W	0.540	10662671320251	6	3947NNH	2.028	10662671052558	7
322042WSS	0.575	10662671320190	6				
322155W	0.591	10662671320732	8	P/L 55			
322158W	2.172	10662671320725	8	5503	0.194	10662671601404	21
322242W	1.085	10662671320237	6	551141BL	0.780	10662671550504	21
322242WSS	1.122	10662671320244	6	551142BL	0.795	10662671550511	21
322342WSS	1.122	10662671320626	6	551143BL	1.250	10662671550528	21
322542W	0.644	10662671320442	6	551144BL	1.210	10662671550535	21
322542WSS	0.681	10662671320459	18	5511930	1.250	10662671610192	21
322925WBN	0.816	10662671320848	18	5511931	1.182	10662671610208	21
323152	0.353	10662671320923	7	551201BL	0.403	10662671610215	20
323502WCRNB	3.336	10662671321081	9	551202BL	0.399	10662671610222	20
323502WCRPB	3.336	10662671321074	9	551203BL	0.666	10662671610239	20
323502WNBW	2.903	10662671321043	9	551203BR	0.666	10662671610390	20
323502WPBM	2.879	10662671321036	9	551204BL	0.701	10662671610246	20
				551204BR	0.703	10662671610406	20
P/L 33				551222BL	0.404	10662671550368	19
331942-2SS	0.121	10662671330786	6	551222BR	0.404	10662671550399	19
331942-2ORB	0.128	10662671333503	6	551222G	0.404	10662671550412	19
331942-2BN	0.104	10662671333497	6	551222WW	0.404	10662671550405	19
331943-2SS	0.121	10662671330809	6	551224BL	0.692	10662671550375	19
331943-2ORB	0.104	10662671333527	6	551224BR	0.692	10662671550443	19
331943-2BN	0.104	10662671333510	6	551224G	0.692	10662671550467	19
331952-1SS	0.132	10662671333428	6	551224WW	0.692	10662671550450	20
331952SS	1.292	662671330864	7	551233BL	0.681	10662671550382	20
331957SS	0.730	10662671330878	7				
331962SS	0.637	10662671330908	7	P/L 60			
331972SS	0.384	10662671330885	7	6008BL	0.572	10662671600117	22
331982SS	0.527	10662671330991	7	6008BR	0.730	10662671600124	22
332042	0.470	10662671330175	6	6008G	0.730	10662671600131	22
332042SS	0.507	10662671330755	6	6008WW	0.730	10662671600155	22
332062BN	-	-	6	6010BL	0.966	10662671600278	22
332062ORB	-	-	6	6010BR	0.966	10662671600285	22
332147SS	0.496	10662671330892	7	6010G	0.966	10662671600315	22
332155	0.463	10662671330939	8	6010-1BC	0.234	10662671600964	22
332158	1.570	10662671330922	8	6011BL	0.966	10662671601046	22
332242	0.860	10662671330359	6	6011BR	0.966	10662671601053	22
332242SS	0.897	10662671330366	6	6011G	0.966	10662671601060	22
332342SS	0.897	10662671330533	6	6011WW	0.966	10662671601084	22
332542	0.527	10662671330458	6	6012BL	0.695	10662671601121	22
332542SS	0.562	10662671330465	6	6012BR	0.695	10662671601138	22
332804TEST	0.119	10662671333022	18	6013BL	0.928	10662671601169	22
332806	0.948	10662671330229	18	6013BR	0.928	10662671601176	22
332925BN	0.816	10662671331325	18	6013WW	0.928	10662671602098	22
332925BNTRIM	0.772	10662671333329	18				
332925CPTRIM	0.772	10662671333312	18				
332925LCP	0.816	10662671333039	18				
332925ORBTRIM	0.441	10662671333299	18				
333053BR	0.492	10662671331141	8				
333054BR	0.653	10662671331004	8				
333056BR	0.602	10662671331103	8				
333058BR	1.065	10662671333459	8				
333063BR	0.461	10662671331110	8				
333064BR	0.710	10662671331127	8				
333067BR	0.571	10662671331134	8				
333068BR	1.065	10662671333442	8				
333153	0.441	10662671331394	7				
P/L 38							
38355NH	0.220	662671380289	22				
383552	3.882	10662671380293	22				
383552-2	0.558	10662671380309	22				
383552-3	0.844	10662671380316	22				
383553	4.096	10662671380194	22				
383554	4.262	10662671380200	22				
383555	3.836	10662671380361	22				
383556	7.251	10662671380231	22				
383556-2	0.979	10662671380323	22				
383556-3	1.190	10662671380330	22				
383557	5.507	10662671021363	22				
383558	7.844	10662671380347	22				
384750	5.800	30662671380211	7				
384750-2	0.681	10662671021479	7				
384750-3	1.252	10662671021493	7				
384751	5.937	30662671380228	7				

SPECIALTY PLUMBING PRODUCTS

PART NO.	WEIGHT (Lbs.)	CARTON BAR CODE	LOCATION IN PRICE LIST	PART NO.	WEIGHT (Lbs.)	CARTON BAR CODE	LOCATION IN PRICE LIST
6010-1BC	0.234	10662671600964	22				
6011BL	0.966	10662671601046	22				
6011BR	0.966	10662671601053	22				
6011G	0.966	10662671601060	22				
6011WW	0.966	10662671601084	22				
6012BL	0.695	10662671601121	22				
6012BR	0.695	10662671601138	22				
6013BL	0.928	10662671601169	22				
6013BR	0.928	10662671601176	22				
6013WW	0.928	10662671602098	22				

SPECIALTY PLUMBING PRODUCTS

PRICE LIST USP-0215-IP FEBRUARY 9, 2015

SPECIALTY PLUMBING PRODUCTS

PRICE LIST USP-0215-IP **FEBRUARY 9, 2015**

SPECIALTY PLUMBING PRODUCTS

PRICE LIST USP-0215-IP **FEBRUARY 9, 2015**



Eastern U.S. Customers

Tel: (289) 881-0120
Toll Free: 1-800-463-9572
Fax: 905-844-1504

www.ipexamerica.com | sales@ipexamerica.com

Western U.S. Customers

Tel: (303) 373-1918
Toll Free: 1-800-461-5307
Fax: (303) 373-1923