

PRICE LIST
U19-0119-IP



IPEX

PVC DWV FITTINGS

SMALL AND LARGE DIAMETER MOLDED FITTINGS

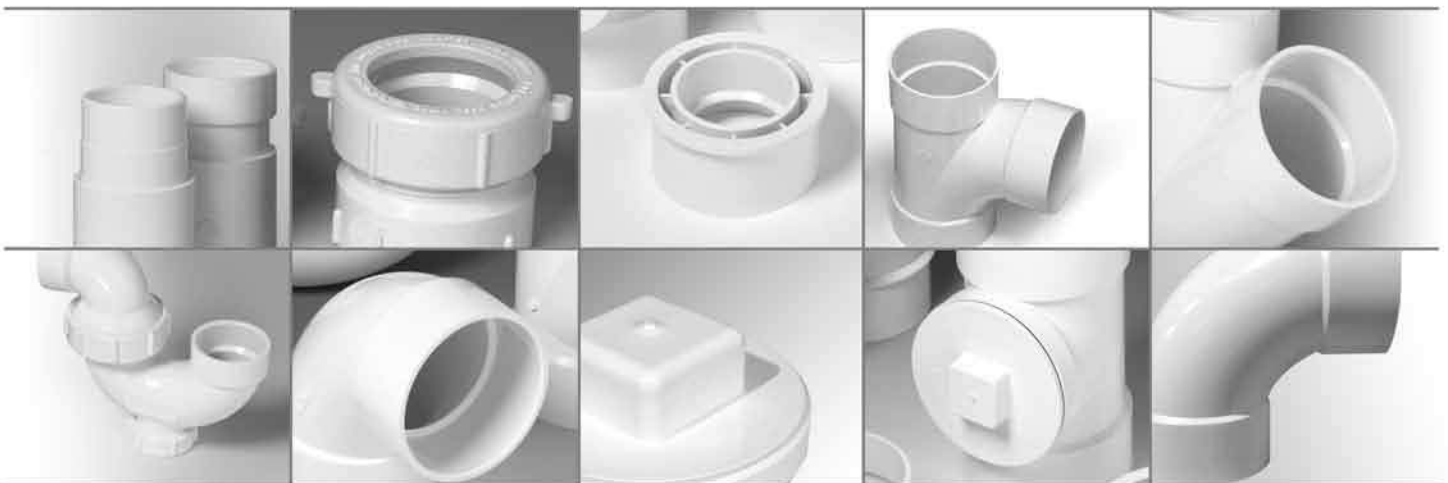

JANUARY 2, 2019
SUPERSEDES U19-0918-IP (SEPTEMBER 4, 2018)

Our website pricing is the current list price and may vary from our printed price list.
Please visit our website for up-to-date information.

www.ipexna.com



Also available from

IPEX
Committed to Excellence

Process Piping Systems



Xirtec 140[®] PVC – Corzan[®] CPVC



Enpure[™] High-purity polypropylene

Acid Waste Systems



Enfield[™] Electrofusion acid waste system



Labline[®] Mechanical joint acid waste system



Plenumline[™] Flame-retardant PVDF mechanical joint acid waste system

Thermoplastic Valves



IPEX offers a variety of manual & actuated valves in PVC, CPVC, PP, PVDF and ABS

Double Containment Systems



Encase[™] Polypropylene double containment system



PAL-AT Cable Leak Detection



Drain-Guard[™] DWV double containment system



CustomGuard[™] Custom designed and fabricated double containment systems



Centra-Guard[™] Patented electronic low point leak detection system



Clear-Guard[™] Pressure rated clear containment PVC system

Compressed Air



Duratec[®] Airline



Duraplus[™] Airline
A high-impact, ductile ABS pressurized piping system

Specialty Products



Ventilation Duct
Seamless PVC & CPVC ventilation duct systems



Well Casings
PVC corrosion-resistant, maintenance-free casings for well-drop-pipe and submersible pumps



Grooved PVC Pipe
Schedule 40, 80, SDR 26 and SDR 21 factory-grooved PVC pipe

PVC DWV FITTINGS

PRICE LIST U19-0119-IP JANUARY 2, 2019

TERMS AND CONDITIONS OF SALE

TERMS

Cash discount 2% 10 days, net 30. The cash discount is allowed on merchandise only. Prices are subject to change and each order will be priced on the basis of prices in effect at the time of order. All orders are subject to approval of our office. Possession of this price list does not necessarily constitute an offer by the Company to sell to the holder on the basis of the terms described hereon.

MINIMUM ORDER

\$250.00 net.

OVERDUE INVOICES

Interest charged at a rate of 1.5% per month on all overdue invoices.

FREIGHT

\$1500.00 net for prepaid freight.

All shipments are F.O.B. seller's factory or authorized warehouse.

Prepaid orders will be shipped via the most economical route of our choice. If the Customer selects a route with a higher rate, the difference will be charged to the Customer.

WEBSITE

Our website pricing is the current list price and may vary from our printed price list. Please visit www.ipexna.com for up-to-date information.

Prices and product availability are subject to change without notice.

While we try to ensure accuracy, we reserve the right to correct any errors in pricing or descriptions, and to cancel or refuse to accept any order based on an incorrect price or description. Such corrections may be made even after an order is accepted.

SHIPPING RESPONSIBILITY

The responsibility of IPEX USA LLC. ceases when the carrier signs for the shipment in good order. We cannot be responsible for loss or damage to goods in transit, or delays or carriers in delivering shipments or for damages resulting from such delays as those caused by fire, explosion, act of God, strike or other difference with workmen, shortage of material or labor, delays in transportation, government restrictions, war, riot, civil commotion or cause beyond our control. Where shortage or damage is apparent, details should be noted by the carrier on the freight bill at the time of delivery. In case of concealed damage, carrier should be called at once to inspect the damaged shipment. Do not return damaged goods.

RETURNED GOODS

A Returned Goods Authorization Form issued by IPEX USA LLC. must accompany goods which are returned. We reserve the right to refuse the return of any item that is not a regular stock item with IPEX USA LLC. On items that are acceptable for credit, a restocking charge of twenty-five percent (25%) will be assessed against the credit to cover our handling, and/or inspecting or repackaging. Freight on returned goods will be the responsibility of the customer unless the reason for the return is due to defective goods. All goods returned must be in a saleable condition.

WARRANTY

Seller's products are carefully inspected for manufacturing defects, however, it is not always possible to detect hidden defects. Said products are warranted only to the extent that Seller will replace without charge, products proven to have manufacturing defects within 6 months of the date of delivery thereof and provided Seller has been given an opportunity to inspect the product alleged to be defective and the installation or use thereof. NO WARRANTY IS INCLUDED AGAINST ANY EXPENSE FOR REMOVAL, REINSTALLATION OR OTHER CONSEQUENTIAL DAMAGES ARISING FROM ANY DEFECT. THE WARRANTIES SET OUT ABOVE ARE THE ONLY WARRANTIES MADE BY SELLER AND ARE EXPRESSLY IN LIEU OF ALL OTHER WARRANTIES, EXPRESSED OR IMPLIED, INCLUDING THE WARRANTIES OF MERCHANTABILITY AND FITNESS FOR A PARTICULAR PURPOSE.

IPEX USA LLC. reserves the right to change the aforementioned TERMS AND CONDITIONS OF SALE without notice.

CAUTION

The Seller does not recommend the use of thermoplastic piping systems for transport or storage of compressed air or other compressed gases or the testing of such systems with compressed air or other compressed cases, in exposed, above ground locations. Use of plastic piping products in exposed compressed gas systems voids our warranty for the products so used. For further information, contact your IPEX USA LLC. representative.

OTHER

In addition to sizes listed in this price list, other sizes may be available upon request.

The product names used in this price list are for identification purposes only. All trademarks and registered trademarks are the property of their respective owners.

TABLE OF CONTENTS Page

COUPLINGS	4
BUSHINGS	4
REDUCER BUSHINGS	4
ADAPTERS	4
CLEANOUT ADAPTERS	4
CLEANOUT PLUGS	5
CAPS	5
22-1/2° ELBOWS	5
45° ELBOWS	5
60° ELBOWS	5
90° ELBOWS	6
WYES	6
DOUBLE FIXTURE FITTINGS	7
TEES	7
CLEANOUTS	11
P TRAPS	11
TRAP ADAPTERS	11
ONE PIECE CLOSET FLANGES	13
EASY OPEN CLOSET FLANGES	14
ADJUSTABLE CLOSET FLANGES	15
OFFSET CLOSET FLANGES	15
45° CLOSET FLANGES	15
CLOSET FLANGE ACCESSORIES	15
URINAL FLANGES	15
90° CLOSET ELBOWS	16
EXPANSION JOINTS	16
CAST IRON ADAPTERS	17
ADAPTER COUPLINGS	17
ADAPTER BUSHINGS	17
GRATES	17
TEST PLATES	17
INDEX	17

PVC DWV FITTINGS

PRICE LIST U19-0119-IP JANUARY 2, 2019

PART #	PRODUCT CODE	PRICE CLASS	SKID QTY.	CTN. QTY.	SIZE	PRICE EACH
--------	--------------	-------------	-----------	-----------	------	------------

COUPLINGS

COUPLING - H x H

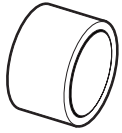

193001	755280	C19A	9000	125	1½	2.79
193002	755282	C19A	4800	100	2	3.82
193003	755284	C19A	1440	20	3	13.33
193004	755286	C19A	800	25	4	22.65
193006	755288	C19A	216	12	6	74.71
193008	026153	C19A	-	-	8	112.98

REPAIR COUPLING (No Pipe Stop) - H x H

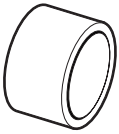

193001R	755281	C19A	8640	60	1½	15.42
193002R	755283	C19A	3600	25	2	10.75
193003R	755285	C19A	1440	45	3	27.21
193004R	755287	C19A	-	5	4	52.34

REDUCER COUPLING - H x H



193022	755290	C19A	5400	75	2 x 1½	8.54
193023	755291	C19A	2520	35	3 x 1½	25.01
193024	755292	C19A	2520	35	3 x 2	19.35
193025	755293	C19A	720	10	4 x 2	38.16
193026	755294	C19A	960	30	4 x 3	40.80
193037	755302	C19A	288	12	6 x 4	158.69
193038	026514	C19A	-	2	8 x 4	200.99
193039	026517	C19A	-	8	8 x 6	161.60

BUSHINGS

FLUSH BUSHING - Spg x H



192752	755200	C19A	10800	150	2 x 1½	4.85
192762	755204	C19A	2520	35	3 x 1½	23.43
192754	755201	C19A	2880	60	3 x 2	12.26
192758	755203	C19A	1440	20	4 x 2	40.73
192756	755202	C19A	1680	35	4 x 3	20.91
192766	755205	C19A	384	12	6 x 3	94.43
192767	755206	C19A	384	12	6 x 4	104.62
192770	026936	C19A	-	4	8 x 6	186.38
192774	026935	C19C	-	1	10 x 8	430.62
192775	026891	C19C	-	1	12 x 10	708.25

REDUCER BUSHINGS

EXTENDED BUSHING - Spg x H

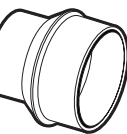

192768	026053	C19A	-	10	6 x 4	165.23
192769	026150	C19A	-	1	8 x 4	285.90
192771	026151	C19A	-	1	8 x 6	276.92
192735	026119	C19C	-	2	10 x 4	308.25
192736	026193	C19C	-	2	10 x 6	317.97
192737	026889	C19C	-	2	10 x 8	327.68
192738	026467	C19C	-	3	12 x 4	466.97
192739	026469	C19C	-	1	12 x 6	546.06
192740	026917	C19C	-	2	12 x 8	573.34

PART #	PRODUCT CODE	PRICE CLASS	SKID QTY.	CTN. QTY.	SIZE	PRICE EACH
--------	--------------	-------------	-----------	-----------	------	------------

ADAPTERS

MALE ADAPTER - MPT x H

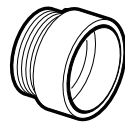

192860	755234	C19A	-	100	1¼ x 1½	7.74
192871	755260	C19A	9000	125	1½	5.35
192872	755261	C19A	5760	80	2	7.19
192873	755262	C19A	2160	30	3	20.05
192874	755263	C19A	1080	15	4	45.38
192876	755264	C19A	240	5	6	88.92

FEMALE ADAPTER - H x FPT

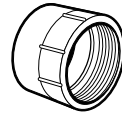

192891	755270	C19A	7200	100	1½	5.31
192892	755271	C19A	5400	75	2	9.08
192893	755272	C19A	1440	30	3	24.20
192894	755273	C19A	800	25	4	31.24
192896	026453	C19A	-	10	6	91.75

CLEANOUT ADAPTERS

FITTING CLEANOUT ADAPTER, with Plug - Spg x FPT

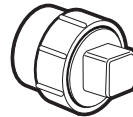

193701AS	755500	C19A	7200	100	1½	11.73
193702AS	755502	C19A	5760	40	2	14.26
193703AS	755504	C19A	1680	35	3	34.38
193704AS	755506	C19A	720	10	4	54.75
193706AS	755508	C19A	240	5	6	159.99
193708A	026534	C19C	-	8	8	436.61
193705A	026536	C19C	-	2	10	1298.85
193707A	026537	C19C	-	2	12	1897.90

FITTING CLEANOUT ADAPTER, with Plug - H x H x FPT

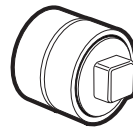

192898A	026596	C19C	-	4	8	496.14
192895A	026597	C19C	-	2	10	1298.85
192897A	026600	C19C	-	2	12	1897.90

FITTING CLEANOUT ADAPTER - Spg x FPT



193701S	755501	C19A	7200	100	1½	6.78
193702S	755503	C19A	5760	40	2	9.08
193703S	755505	C19A	1680	35	3	24.35
193704S	755507	C19A	720	10	4	40.02
193706S	755509	C19A	320	10	6	113.96

TWO-WAY CLEANOUT FITTING - H x H x H



193723	755520	C19A	270	15	3	92.92
193724	755521	C19A	144	8	4	120.27
193726	026001	C19A	-	3	6	949.31

PVC DWV FITTINGS

PRICE LIST U19-0119-IP JANUARY 2, 2019

PART #	PRODUCT CODE	PRICE CLASS	SKID QTY.	CTN. QTY.	SIZE	PRICE EACH
--------	--------------	-------------	-----------	-----------	------	------------

CLEANOUT PLUGS

CLEANOUT PLUG - MPT

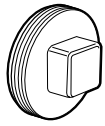

193051S	755311	C19A	17280	120	1½	5.02
193052S	755314	C19A	10800	150	2	5.63
193053S	755317	C19A	4320	30	3	10.05
193054S	755320	C19A	2160	30	4	14.81
193057S	755323	C19A	1152	8	6	47.35

COUNTERSUNK PLUG - MPT

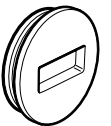

193062	755325	C19A	5760	40	2	18.25
193063	755326	C19A	-	50	3	21.24
193064	755327	C19A	-	25	4	21.46
193066	755328	C19A	1440	20	6	53.29

CAPS

POLYETHYLENE CAP Slip-on Style - Orange

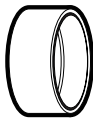

10TC315	750005	C10	14400	200	1½	See U10 Price list
10TC316	750015	C10	10800	150	2	See U10 Price list
10TC318	750020	C10	2520	35	3	See U10 Price list
10TC320	750025	C10	1920	40	4	See U10 Price list
10TC322	750030	C10	480	10	6	See U10 Price list

PVC CAP - Hub

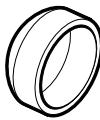

193081	755340	C19A	12960	90	1½	11.31
193082	755341	C19A	7920	110	2	18.88
193083S	755342	C19A	2160	30	3	31.57
193084S	755343	C19A	1200	25	4	45.08
193086	755344	C19A	384	12	6	113.82
193088	026888	C19C	-	-	8	278.44
193085	026283	C19C	-	2	10	294.31

PVC PLUG - Spg

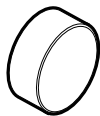

193094	026933	C19A	-	4	4	75.88
193096	026934	C19A	-	1	6	237.95
192898	026598	C19C	-	6	8	269.71
193095	026558	C19C	-	2	10	344.00
193097	026559	C19C	-	2	12	431.31

22-1/2° ELBOWS

1/16 BEND (22½°) - H x H



192551	755175	C19A	5400	75	1½	8.26
192552	755176	C19A	2400	50	2	9.78
192553	755177	C19A	960	20	3	24.29
192554	755178	C19A	480	15	4	38.37
192556	755179	C19A	144	8	6	221.66

PART #	PRODUCT CODE	PRICE CLASS	SKID QTY.	CTN. QTY.	SIZE	PRICE EACH
--------	--------------	-------------	-----------	-----------	------	------------

1/16 BEND, Street (22½°) - Spg x H



192561	755185	C19A	6480	90	1½	22.36
192562	755186	C19A	3240	45	2	23.92
192563	755187	C19A	960	30	3	37.62
192564	755188	C19A	480	15	4	54.57
192566	755189	C19A	144	8	6	214.76

45° ELBOWS

1/8 BEND (45°), LONG TURN - H x H



192501	755160	C19A	4000	125	1½	5.81
192502	755161	C19A	2160	45	2	8.66
192503	755162	C19A	640	20	3	24.62
192504	755163	C19A	320	10	4	45.07
192508	026102	C19A	-	1	8	200.03
192505	026170	C19C	-	1	10	458.62
192507	026188	C19C	-	1	12	694.18

1/8 BEND (45°), SHORT TURN - H x H



192506	755164	C19A	144	8	6	167.89
--------	--------	------	-----	---	---	--------

1/8 BEND, Street (45°), LONG TURN - Spg x H



192401	755140	C19A	3600	50	1½	5.56
192402	755141	C19A	2160	45	2	8.84
192403	755142	C19A	640	20	3	23.33
192404	755143	C19A	320	10	4	40.00
192408	026100	C19A	-	-	8	217.11
192405	026112	C19C	-	1	10	459.02
192407	026033	C19C	-	1	12	703.39

1/8 BEND, Street (45°), SHORT TURN - Spg x H

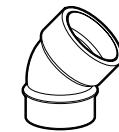

192423	755150	C19A	800	25	3	29.30
192406	755144	C19A	144	8	6	198.87

60° ELBOWS

1/6 BEND (60°) - H x H

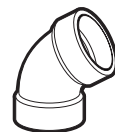

192601	755195	C19A	3600	50	1½	13.92
192604	755198	C19A	320	10	4	79.70

1/6 BEND (60°), LONG TURN - H x H



192602L	755196	C19A	2160	30	2	16.19
192603L	755197	C19A	640	20	3	59.80

PVC DWV FITTINGS

PRICE LIST U19-0119-IP JANUARY 2, 2019

PART #	PRODUCT CODE	PRICE CLASS	SKID QTY.	CTN. QTY.	SIZE	PRICE EACH
--------	--------------	-------------	-----------	-----------	------	------------

90° ELBOWS

1/4 BEND (90°) - H x H



192221	755075	C19A	2400	50	1½ x 2	34.35
192251L	755086	C19A	3520	110	1½	5.95
192252L	755087	C19A	1600	50	2	9.35
192253L	755088	C19A	480	15	3	27.48
192254L	755089	C19A	270	15	4	54.27
192256	755090	C19A	72	4	6	191.59
192258	026091	C19A	-	1	8	225.26
192255	026065	C19C	-	1	10	592.20
192257	026134	C19C	-	1	12	912.08

1/4 BEND, Street (90°) - Spg x H



192451L	755151	C19A	3240	45	1½	7.69
192452L	755153	C19A	1600	50	2	11.79
192453L	755154	C19A	480	15	3	32.85
192454L	755155	C19A	270	15	4	55.25
192456	755156	C19A	72	4	6	247.12
192458	026501	C19A	-	3	8	436.28
192455	026393	C19C	-	1	10	943.95
192457	026118	C19C	-	1	12	1432.70

1/4 BEND (90°), LONG SWEEP - H x H

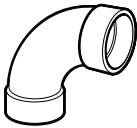

192276	755100	C19A	2400	50	1½	13.78
192277	755101	C19A	1440	45	2	15.34
192278	755102	C19A	480	15	3	35.33
192279	755103	C19A	216	12	4	67.05

1/4 BEND, Street (90°), LONG SWEEP - Spg x H



195276	755615	C19A	2160	30	1½	21.24
195277	755616	C19A	1200	25	2	25.44
195278	755617	C19A	450	25	3	63.32

VENT ELL (90°) - H x H



192201	755070	C19A	3600	50	1½	12.29
192202	755071	C19A	2520	35	2	15.97
192203	755072	C19A	640	20	3	41.35

1/4 BEND (90°), with Low Heel Inlet (90°) - H x H x H



192245	755080	C19A	450	25	3 x 3 x 2	47.71
192249	755082	C19A	-	10	4 x 4 x 2	94.19

1/4 BEND (90°), Street with Low Heel Inlet - H x H x Spg



192248	755081	C19A	480	15	3 x 3 x 2	136.45
--------	--------	------	-----	----	-----------	--------

PART #	PRODUCT CODE	PRICE CLASS	SKID QTY.	CTN. QTY.	SIZE	PRICE EACH
--------	--------------	-------------	-----------	-----------	------	------------

WYES

WYE - H x H x H

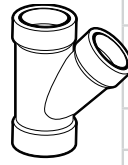

192301L	755120	C19A	1760	55	1½	18.98
192302L	755121	C19A	800	25	2	18.57
192303L	755122	C19A	270	15	3	50.13
192304L	755123	C19A	160	5	4	91.19
192306	755124	C19A	36	2	6	264.78
192324	755126	C19A	1200	25	2 x 1½ x 1½	26.12
192325L	755127	C19A	1120	35	2 x 2 x 1½	22.86
192331L	755131	C19A	480	15	3 x 3 x 1½	33.80
192326L	755128	C19A	480	15	3 x 3 x 2	37.09
192328L	755130	C19A	270	15	4 x 4 x 2	54.90
192327L	755129	C19A	180	10	4 x 4 x 3	74.01
192343	755132	C19A	72	4	6 x 6 x 3	257.24
192344	755133	C19A	72	4	6 x 6 x 4	213.79
192308	026094	C19A	-	1	8	424.81
192305	026303	C19C	-	1	10	826.99
192307	026493	C19C	-	1	12	1343.38
192333	026093	C19A	-	1	8 x 8 x 4	410.22
192334	026095	C19A	-	1	8 x 8 x 6	422.95
192338	026374	C19C	-	1	12 x 12 x 6	796.62

WYE, Street - Spg x H x H



195326L	755621	C19A	-	25	3 x 3 x 2	57.73
---------	--------	------	---	----	-----------	-------

Visit our website for more information

- Specification Sheets
- E-Newsletter
- Price Lists

www.ipexna.com



PVC DWV FITTINGS

PRICE LIST U19-0119-IP **JANUARY 2, 2019**

PART #	PRODUCT CODE	PRICE CLASS	SKID QTY.	CTN. QTY.	SIZE	PRICE EACH
--------	--------------	-------------	-----------	-----------	------	------------

PART #	PRODUCT CODE	PRICE CLASS	SKID QTY.	CTN. QTY.	SIZE	PRICE EACH
--------	--------------	-------------	-----------	-----------	------	------------

LONG TURN TEE WYE, Single - H x H x H



194301	755570	C19A	1280	40	1½	25.26
194302	755571	C19A	800	25	2	31.55
194303	755572	C19A	240	10	3	69.04
194304	755573	C19A	90	5	4	136.79
194317	755580	C19A	-	35	2 x 1½ x 1½	48.41
194320	755581	C19A	960	20	2 x 2 x 1½	35.51
194326	755582	C19A	480	15	3 x 3 x 1½	63.32
194327	755583	C19A	384	12	3 x 3 x 2	47.16
194337	755584	C19A	270	15	4 x 4 x 2	71.46
194338	755585	C19A	144	8	4 x 4 x 3	92.19
192716	026609	C19A	-	1	6	479.33
192718	026612	C19A	-	8	8	723.31
192713	026610	C19A	-	1	8 x 8 x 4	398.65
192715	026611	C19A	-	1	8 x 8 x 6	654.83

DOUBLE WYE - H x H x H x H



192352	755134	C19A	-	20	2	50.69
192354	026240	C19A	-	5	4	194.43
192356	026701	C19A	-	2	6	363.45
192355	026098	C19A	-	-	6 x 6 x 4	508.55

DOUBLE WYE - H x H x H x H

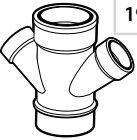

195376	755622	C19A	320	10	3x3x1½x1½	83.84
--------	--------	------	-----	----	-----------	-------

DOUBLE FIXTURE FITTINGS

DOUBLE FIXTURE FITTING - H x H x H x H

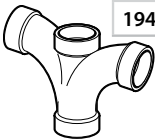

194153	755562	C19A	480	10	2	52.79
194149	755561	C19A	960	20	2x1½x1½x1½	64.98
194154	755563	C19A	180	10	3 x 2 x 3 x 3	109.76
194155	755564	C19A	180	10	3	113.97

DOUBLE 1/4 BEND - H x H x H



192263	755095	C19A	320	10	3	83.86
--------	--------	------	-----	----	---	-------

TEES

SANITARY TEE - H x H x H



192151L	755034	C19A	2240	70	1½	10.35
192152L	755035	C19A	1280	40	2	15.24
192128L	755022	C19A	1600	50	2 x 1½ x 1½	13.43
192127L	755021	C19A	1200	25	2 x 1½ x 2	16.29
192126L	755020	C19A	1440	30	2 x 2 x 1½	13.46
192153	755036	C19A	360	20	3	40.14
192131	755024	C19A	800	25	3 x 3 x 1½	29.33
192130L	755023	C19A	640	20	3 x 3 x 2	30.19
192154L	755037	C19A	216	12	4	73.74
192134	755025	C19A	360	20	4 x 4 x 2	63.44
192136	755026	C19A	270	15	4 x 4 x 3	86.23
192144	755027	C19A	90	5	6 x 6 x 4	286.34
192156	755038	C19A	72	3	6 x 6 x 6	296.08
192158	026013	C19A	-	2	8 x 8 x 8	768.51

SANITARY TEE, Street - Spg x H x H



195151L	755605	C19A	2400	50	1½	31.24
195152L	755606	C19A	1280	40	2	30.30
195153	755607	C19A	360	20	3	50.52
195154L	755608	C19A	180	10	4	127.54
195128L	755602	C19A	1600	50	2 x 1½ x 1½	23.28
195127L	755601	C19A	1280	40	2 x 1½ x 2	21.08
195126L	755600	C19A	1440	20	2 x 2 x 1½	26.70
195130L	755603	C19A	480	10	3 x 3 x 2	49.90
195156	755609	C19A	72	3	6	213.42

SANITARY TEE, with Left Side Inlet - H x H x H x H



192147L	755029	C19A	320	10	3 x 3 x 3 x 1½	108.88
192148L	755031	C19A	320	10	3 x 3 x 3 x 2	72.64

SANITARY TEE, with Right Side Inlet - H x H x H x H



192147R	755030	C19A	320	10	3 x 3 x 3 x 1½	108.88
192148R	755032	C19A	320	10	3 x 3 x 3 x 2	72.64

PVC DWV FITTINGS

PRICE LIST U19-0119-IP **JANUARY 2, 2019**

PART #	PRODUCT CODE	PRICE CLASS	SKID QTY.	CTN. QTY.	SIZE	PRICE EACH
--------	--------------	-------------	-----------	-----------	------	------------

DOUBLE SANITARY TEE - H x H x H x H

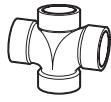

192187	755059	C19A	1080	15	1½	22.96
192186	755058	C19A	720	10	2	31.02
192188	755060	C19A	960	20	2x2x1½x1½	24.35
192184	755056	C19A	240	5	3	86.73
192189	755061	C19A	480	15	3x3x1½x1½	56.48
192181	755055	C19A	480	15	3x3x2x2	61.40
192185	755057	C19A	-	6	4	139.51

REDUCING TEE - H x H x H

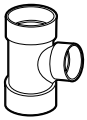

192144L	026945	C19A	-	2	6 x 6 x 4	257.87
192157	026947	C19A	-	2	8 x 8 x 4	677.55
192129	026948	C19A	-	2	8 x 8 x 6	708.29
192138	026951	C19C	-	1	10 x 10 x 4	428.74
192139	026952	C19C	-	1	10 x 10 x 6	527.52
192140	026953	C19C	-	1	10 x 10 x 8	591.83
192141	026955	C19C	-	1	12 x 12 x 4	579.70
192142	026956	C19C	-	8	12 x 12 x 6	661.89
192143	026957	C19C	-	1	12 x 12 x 8	757.02
192145	026958	C19C	-	1	12 x 12 x 10	903.34

VENT TEE - H x H x H



192101	755000	C19A	2160	15	1½	38.75
192102	755001	C19A	1440	20	2	31.75
192104	026200	C19A	-	5	4	120.46
192106	026946	C19A	-	4	6	280.98
192108	026949	C19A	-	2	8	490.02
192105	026392	C19C	-	1	10	667.79
192107	026668	C19C	-	1	12	1110.15

APPLIANCE WYE/GREYWATER TRAP PRIMER

- H x H x Hose Barb

Snap-in Plug is Molded on Fitting for Use During "Rough-In"



212321W	757120	C21	2880	40	1½ x 1½ x ½	See USP Price list
212332W	757125	C21	2880	40	1½ x 1½ x ¾	See USP Price list
212333W	757129	C21	2880	40	1½ x 1½ x 1	See USP Price list

PART #	PRODUCT CODE	PRICE CLASS	SKID QTY.	CTN. QTY.	SIZE	PRICE EACH
--------	--------------	-------------	-----------	-----------	------	------------

HORIZONTAL TWIN TEE



193750	755525	C19A	480	15	3x3x1½x1½	168.96
--------	--------	------	-----	----	-----------	--------



► function

- To provide two 1½" connections to a 3" tee on the same side.

► features

- 3" tee with two side by side 1½" sanitary hub connections.
- Compact design.

► benefits

- Eliminates the need to stack two 3" x 1½" tees on top of each other, avoiding complicated installations.
- Perfect application for back to back fixtures such as sinks and bathtubs.

► approvals

- The Horizontal Twin Tee meets ASTM D2468 and D1784 standards. IAPMO and CSA approval pending.

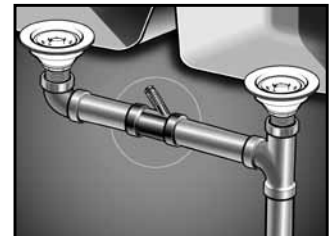

PVC DWV FITTINGS



PVC Backwater Valves

These simple devices offer effective protection against the backflow of sewage and stormwater into homes and businesses.

DESC.	PART #	SKID QTY.	CTN. QTY.	SIZE	PRICE EACH
-------	--------	-----------	-----------	------	------------

BACKWATER VALVE					
PVC (white) - With DWV Hubs					
	223281W	1080	15	1½	See USP Price list
	223282W	1080	15	2	See USP Price list
	223283W	320	10	3	See USP Price list
	223284W	128	4	4	See USP Price list
	223286W	48	1	6	See USP Price list

BACKWATER VALVE with 16" access sleeve and ABS lid					
PVC (white) - With DWV Hubs					
	223271W	-	1	1½	See USP Price list
	223272W	128	1	2	See USP Price list
	223287W	84	1	3	See USP Price list
	223285W	45	1	4	See USP Price list

Under Normal Operation, the lightweight flapper opens and allows waste water to exit to sewer line.

During a backflow, the flapper seals closed, stopping the flow from reaching interior drains entering the living space.

SIZE	LENGTHS PER LIFT	10 FOOT PLAIN END	10 FOOT BELL END	20 FOOT PLAIN END	20 FOOT BELL END
Schedule 40 PVC Pipe					
1/2"	280	022600	022603	022602	022601
3/4"	225	022633	022604	022677	022607
1"	180	022612	022611	022606	022610
1-1/4"	165	022608	022674	022678	022617
1-1/2"	147	022614	022616	022675	022615
2"	98	022618	022619	022679	022620
2-1/2"	78	022621	022622	022646	022625
3"	65	022637	022624	022623	022630
4"	50	022626	022628	022627	022640
5"	38	-	-	022651	022650
6"	20	022666	022659	022665	022660
8"	14	-	-	022681	022680
10"	11	-	-	022691	022690
12"	8	-	-	022693	022692
14"	3	-	-	022682	022694
16"	3	-	-	022683	022696
18"	3	-	-	022687	022697
20"	2	-	-	022702	022698
24"	2	-	-	022704	022699

Schedule 40 PVC Pipe From 1/2" to 24"

IPEX offers Schedule 40 solid wall PVC pipe in sizes 1/2" through 24" which can be used in pressure, DWV and well casing applications. IPEX Schedule 40 PVC pipe conforms to industry standards which includes ASTM D1785, ASTM D2665, ASTM F480 and ANSI/NSF 61.

Contact us for pricing

PVC DWV FITTINGS

- No more glued in test plates
- No more mechanical test plugs or test balls

PermOseal[®] 4" x 3" Reducing Line Cleanout with Test Membrane

New! Innovative test membrane from IPEX enables mess-free removal of the test membrane after a water test.



By puncturing the PVC membrane with a utility knife, wastewater is drained slowly, avoiding the typical torrent of wastewater mess with other test methods.

Simply remove the membrane with a knife after the system is tested.

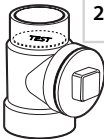

DESC.	PART #	PRODUCT CODE	PRICE CLASS	SKID QTY.	CTN. QTY.	SIZE	PRICE EACH
REDUCING LINE CLEANOUT WITH TEST MEMBRANE							
H x H with Plug & O-ring							
	212107WAT	757073	C21	-	15	4 x 3 x 4	See USP Price list

PVC DWV FITTINGS

PRICE LIST U19-0119-IP **JANUARY 2, 2019**

PART #	PRODUCT CODE	PRICE CLASS	SKID QTY.	CTN. QTY.	SIZE	PRICE EACH
--------	--------------	-------------	-----------	-----------	------	------------

CLEANOUTS

CLEANOUT TEE - H x H x FPT

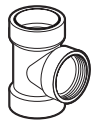

192114S	755007	C19A	2520	35	1½	21.10
192115S	755009	C19A	1440	30	2	24.71
192116S	755011	C19A	576	18	3	47.92
192117S	755013	C19A	270	15	4	85.54

CLEANOUT TEE with Plug & O-ring - H x H



212117AW	757091	C21	240	10	4	See USP Price list
----------	--------	-----	-----	----	---	--------------------

CLEANOUT TEE with Plug - H x H x FPT



192114AS	755006	C19A	2160	30	1½	26.12
192115AS	755008	C19A	1440	20	2	30.30
192116AS	755010	C19A	480	15	3	57.99
192117AS	755012	C19A	270	15	4	100.27
192118A	755014	C19A	72	4	6	481.29
192898T	026959	C19A	-	1	8	800.26

REDUCING LINE CLEANOUT with Plug & O-ring - H x H

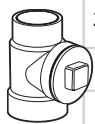

212107A	757070	C21	270	15	4 x 3	See USP Price list
192106A	026529	C19A	-	1	6 x 4	603.44
192108A	026116	C19A	-	1	8 x 4	626.01
192124A	026531	C19A	-	1	8 x 6	630.03

P TRAPS

P TRAP, with Solvent Weld Joint - H x H

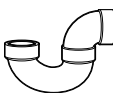

193201S	755363	C19A	1280	40	1½	22.02
193202	755364	C19A	640	20	2	26.80
193203	755367	C19A	180	10	3	91.14
193204	755370	C19A	108	6	4	219.49
193206	755096	C19A	-	1	6	454.92

P TRAP, with Cleanout & Solvent Weld Joint - H x H



193201AS	755362	C19A	1120	35	1½	33.87
----------	--------	------	------	----	----	-------

P TRAP U-Bend - H x H



193201-1S	755360	C19A	2400	75	1½	18.95
193202-1	755365	C19A	960	20	2	36.01
193203-1	755368	C19A	320	10	3	101.01
193204-1	755371	C19A	180	10	4	183.46
193206-1	755373	C19A	48	2	6	256.41

PART #	PRODUCT CODE	PRICE CLASS	SKID QTY.	CTN. QTY.	SIZE	PRICE EACH
--------	--------------	-------------	-----------	-----------	------	------------

P Traps Continued

P TRAP, with Union - H x H

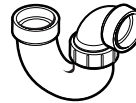

193211N	755380	C19A	1280	40	1½	26.38
193212E	755390	C19A	640	20	2	60.81

P TRAP LA PATTERN, with Union - Slip x H



193221A	755400	C19A	800	25	1½	45.66
---------	--------	------	-----	----	----	-------

TRAP ADAPTERS

SANITARY TEE TRAP ADAPTER - H x H x Slip Joint



212171AW	757095	C21	1600	50	1½	See USP Price list
----------	--------	-----	------	----	----	--------------------

90° TRAP ADAPTER - H x Slip Joint, Ideal for Pedestal Sinks



212286AW	757110	C21	3600	50	1½ x 1¼	See USP Price list
212281AW	757105	C21	3600	50	1½ x 1½	See USP Price list

TRAP ADAPTER, with Washer & Nut - H x Slip



192851A	755231	C19A	7200	100	1½	9.90
192860A	755235	C19A	7200	100	1½ x 1¼	10.39

TRAP ADAPTER, with One-piece Poly Nut - H x Slip



192853A	755232	C19A	7200	100	1½	10.47
192855A	755233	C19A	7200	100	1¼ x 1½	10.53

PVC DWV FITTINGS

PRICE LIST U19-0119-IP JANUARY 2, 2019



PermOseal®

Kitchen and Bathroom P-Traps



Material

Available in ABS (Black) and PVC (White) with or without cleanout.



(Patent # 6,859,956)

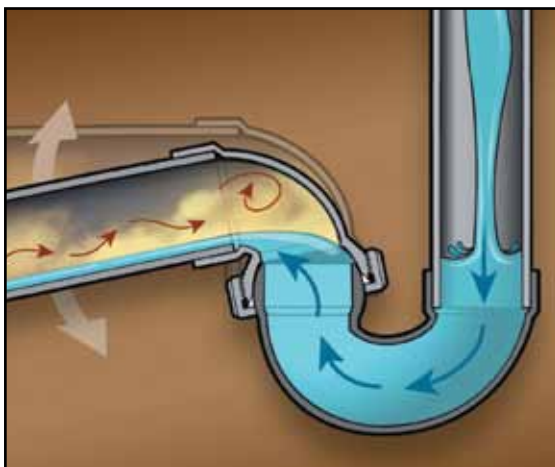

Connection

Adjustable joint allows up to 10° of angle adjustment providing ease of installation in situations with pipe misalignment or offset fittings while maintaining a secure seal.

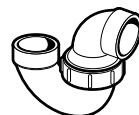

DESC.	PART #	PRODUCT CODE	PRICE CLASS	SKID QTY.	CTN. QTY.	SIZE	PRICE EACH
PERMOSEAL® P TRAP with Union Connection & Cleanout - H x H							
	193231A	755410	C19A	1120	35	1½	32.53

PERMOSEAL® P TRAP, with Union Connection - H x H							
	193231E	755411	C19A	1120	35	1½	25.59

PVC DWV FITTINGS

PRICE LIST U19-0119-IP **JANUARY 2, 2019**

PART #	PRODUCT CODE	PRICE CLASS	SKID QTY.	CTN. QTY.	SIZE	PRICE EACH
--------	--------------	-------------	-----------	-----------	------	------------

TRAP ADAPTERS Continued

FITTING TRAP ADAPTER, with Washer & Nut - Spg x Slip



192801A	755211	C19A	7200	100	1½	11.34
193211Y	755385	C19A	7200	100	1½ x 1¼	12.47

FITTING TRAP ADAPTER, with One-piece Poly Nut - Spg x Slip



192804A	755214	C19A	7200	100	1½	11.00
192806A	755215	C19A	7200	100	1¼ x 1½	11.95

FITTING TRAP ADAPTER, less Washer & Nut (Fitting Male Adapter) - Spg x MPT



192801	755210	C19A	-	100	1½	10.35
192802	755212	C19A	-	25	2	34.80

FITTING TRAP ADAPTER, less Washer & Nut (Fitting Female Adapter) - H x MPT



192851	755230	C19A	-	125	1½	8.82
--------	--------	------	---	-----	----	------

COPPER TO DWV PIPE ADAPTER - H x Slip



192861A	755242	C19A	5760	80	1½	6.81
---------	--------	------	------	----	----	------

SANITARY TEE SINK STRAINER ADAPTER H x H x Strainer Adapter (with Gasket)

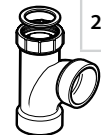

212191AW	757100	C21	1600	50	1½	See USP Price list
----------	--------	-----	------	----	----	--------------------

90° SINK STRAINER ADAPTER H x Strainer Adapter (with Gasket)



212291AW	757115	C21	3600	50	1½	See USP Price list
----------	--------	-----	------	----	----	--------------------

TRAY PLUG ADAPTER - H x FPT



193211-9	755074	C19A	-	40	1½	15.55
----------	--------	------	---	----	----	-------

PART #	PRODUCT CODE	PRICE CLASS	SKID QTY.	CTN. QTY.	SIZE	PRICE EACH
--------	--------------	-------------	-----------	-----------	------	------------

SLIP JOINT NUT



193930	755545	C19A	-	1000	1¼	4.16
193931	755546	C19A	-	1000	1½	2.89

SLIP JOINT WASHER



109210-004	752302	C10	57600	800	1½	See U10 Price list
109210-005	752304	C10	7200	400	2	See U10 Price list

ONE PIECE CLOSET FLANGES

CLOSET FLANGE, One Piece Plastic - Hub End with Gussets



193604	755451	C19A	800	25	4	49.86
--------	--------	------	-----	----	---	-------

CLOSET FLANGE, One Piece Plastic - With molded test plate



193632	755473	C19A	800	25	4 x 3	28.74
--------	--------	------	-----	----	-------	-------

CLOSET FLANGE, One Piece Plastic - Hub



193633	755474	C19A	800	25	4 x 3	24.98
--------	--------	------	-----	----	-------	-------

CLOSET FLANGE, One Piece Plastic - Hub



Flush Fit						
193603	755450	C19A	800	25	4	45.30
193631††	755470	C19A	-	25	4 x 3	45.30
Without Pipe Stop						
193631X††	755472	C19A	800	25	4 x 3	40.95
213631XW††	757197	C21	800	25	4 x 3	See USP Price list
With Molded Test Plate						
193631T††	755471	C19A	800	25	4 x 3	45.98

†† Fits over 3" or inside 4" Schedule 40 DWV pipe

‡‡ Fits over 3" DWV or inside 4" SDR 35 pipe

PVC DWV FITTINGS

PRICE LIST U19-0119-IP JANUARY 2, 2019



• No more hammers
• No more damage!

New!



IPEX **EO**

No Hammer- Easy Open Test Cap Closet Flanges

New!
Innovative test membrane from IPEX enables mess-free removal of the test membrane after a water test.

Simply remove the membrane with a knife after the system is tested.

• Patent Pending



DESC.	PART #	PRODUCT CODE	PRICE CLASS	SKID QTY.	CTN. QTY.	SIZE	PRICE EACH
-------	--------	--------------	-------------	-----------	-----------	------	------------

**IPEX EO, No Hammer/Easy Open
TEST CAP CLOSET FLANGE**

One piece flush fit easy open closet flange with pipe stop							
213631WEO	757064	C21	800	25	4 x 3		See USP Price list
Adjustable flush fit easy open closet flange without pipe stop							
213627XWSSEO	757172	C21	800	25	4 x 3		See USP Price list

PVC DWV FITTINGS

PRICE LIST U19-0119-IP JANUARY 2, 2019

PART #	PRODUCT CODE	PRICE CLASS	SKID QTY.	CTN. QTY.	SIZE	PRICE EACH
--------	--------------	-------------	-----------	-----------	------	------------

ADJUSTABLE CLOSET FLANGES

CLOSET FLANGE, Adjustable



Hub End with Adjustable Metal Ring						
193611M	755453	C19A	960	30	4	80.63
193614M	755455	C19A	800	25	4 x 3	71.04



Hub End, Flush Fit with Adjustable Plastic Ring						
193624	755459	C19A	800	25	4 x 3	42.16



Spigot End with Adjustable Metal Ring						
193612M	755454	C19A	-	25	4	77.35
193616M	755456	C19A	-	25	4 x 3	64.64



Extended Spigot with Adjustable Stainless Steel Ring (with 3-1/2" ext. spigot)						
193617SS	755458	C19A	450	25	3	64.41

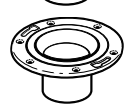

Extended Spigot with Adjustable Metal Ring Ext. (with 3-1/2" ext. spigot)						
193617M	755457	C19A	450	25	3	64.41

WARNING

IPEX recommends sponge rubber and wax gaskets only for use with all closet flanges.

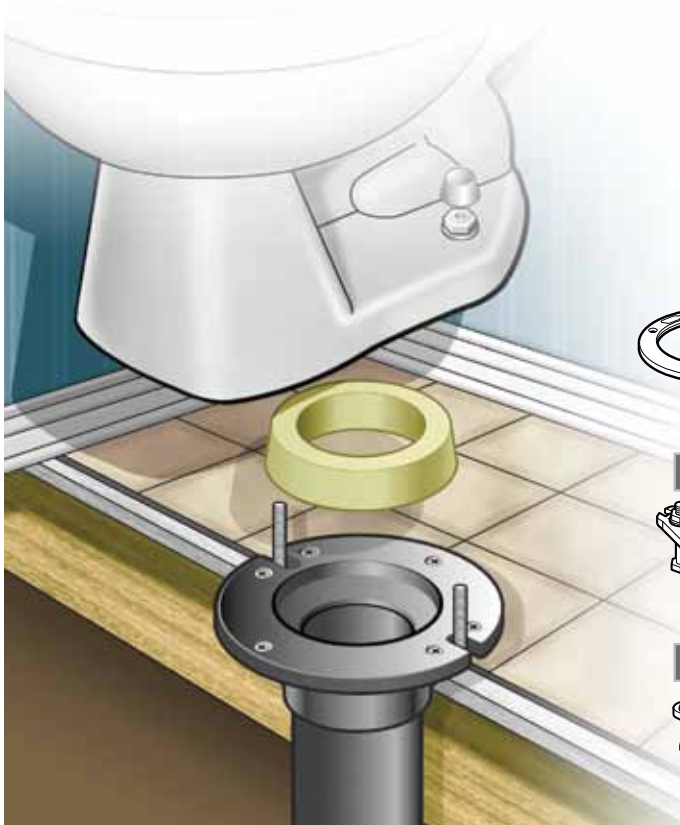

PART #	PRODUCT CODE	PRICE CLASS	SKID QTY.	CTN. QTY.	SIZE	PRICE EACH
--------	--------------	-------------	-----------	-----------	------	------------

OFFSET CLOSET FLANGES

OFFSET CLOSET FLANGE - Hub (Offset 1 1/2")



With adjustable metal ring						
193639M	755480	C19A	600	25	4 x 3	92.56

With stainless steel ring						
193639SS	755481	C19A	600	25	4 x 3	81.74

With adjustable metal ring						
213639WSS	757216	C21	600	25	4 x 3	See USP Price list

OFFSET CLOSET FLANGE - Hub (Offset 1 1/2")



With adjustable plastic ring						
193644	755483	C19A	480	15	4 x 3	126.09

45° CLOSET FLANGES

45° DISCHARGE CLOSET FLANGE - Hub



With adjustable plastic ring						
213628W	757181	C21	640	20	4 x 3	See USP Price list

With adjustable metal ring						
213628MW	757176	C21	640	20	4 x 3	See USP Price list

With adjustable stainless steel ring						
213628WSS	757188	C21	640	20	4 x 3	See USP Price list

CLOSET FLANGE ACCESSORIES

CLOSET FLANGE SPACER RING



219180-002W	757280	C21	3600	25	4 x 3	See USP Price list
-------------	--------	-----	------	----	-------	--------------------

URINAL FLANGES

URINAL FLANGE KIT - Spigot

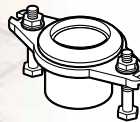

213660W††	757233	C21	1200	25	2	See USP Price list
-----------	--------	-----	------	----	---	--------------------

213661W‡‡	757240	C21	1440	20	2	See USP Price list
-----------	--------	-----	------	----	---	--------------------

URINAL FLANGE KIT - Hub

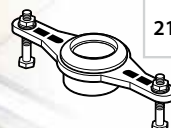

213663W‡‡	757255	C21	1440	20	2	See USP Price list
-----------	--------	-----	------	----	---	--------------------

†† with 4" Center ‡‡ with Adjustable Center: 4" - 7"

PVC DWV FITTINGS

PRICE LIST U19-0119-IP JANUARY 2, 2019

PART #	PRODUCT CODE	PRICE CLASS	SKID QTY.	CTN. QTY.	SIZE	PRICE EACH
--------	--------------	-------------	-----------	-----------	------	------------

90° CLOSET ELBOWS

CLOSET BEND, Reducing - Spg x H

193103	755350	C19A	360	20	4 x 3	86.78
--------	--------	------	-----	----	-------	-------



CLOSET BEND, Reducing - H x H

192223	755076	C19A	360	20	4 x 3	44.20
--------	--------	------	-----	----	-------	-------

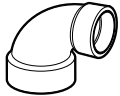

CLOSET BEND, Reducing with Test Cap - Spg x H

193103A	755351	C19A	320	10	4 x 3	111.26
---------	--------	------	-----	----	-------	--------



EXPANSION JOINTS

EXPANSION JOINT - H x H

TYPE I - 3" Travel

213811AWBC	757288	C21	1728	12	1½	See USP Price list
213812AWBC	757289	C21	1080	15	2	See USP Price list
213813AWBC	757290	C21	480	15	3	See USP Price list



TYPE II - 8" Travel

213814AWBC	757291	C21	128	4	4	See USP Price list
------------	--------	-----	-----	---	---	--------------------

EXPANSION JOINTS

Allows for the expansion and contraction of pipe due to temperature change and the shrinkage of building materials that the pipe is connected to.

- Injected molded in ABS (Black) and PVC (White).
- Nitrile Buna-N O-ring.
- PQAA Grease #2 lubricant.

Features

- Allows for up to 3" (7.6 cm) of travel (Type I) or 8" (20.3 cm) of travel (Type II).
- Flow direction and proper degree of extension indicated on expansion joint.
- Used in vertical applications.

Benefits

- Allows movement without leakage.
- Removes the stress from both pipe and fittings which could cause failure of the piping system.

Applications

- For Drain, Waste & Vent applications (non-pressure).
- For Log Homes.
- For straight pipe runs of 30 ft. (9.1 m) or longer.

Approvals

- CSA Certified, IAPMO Listed

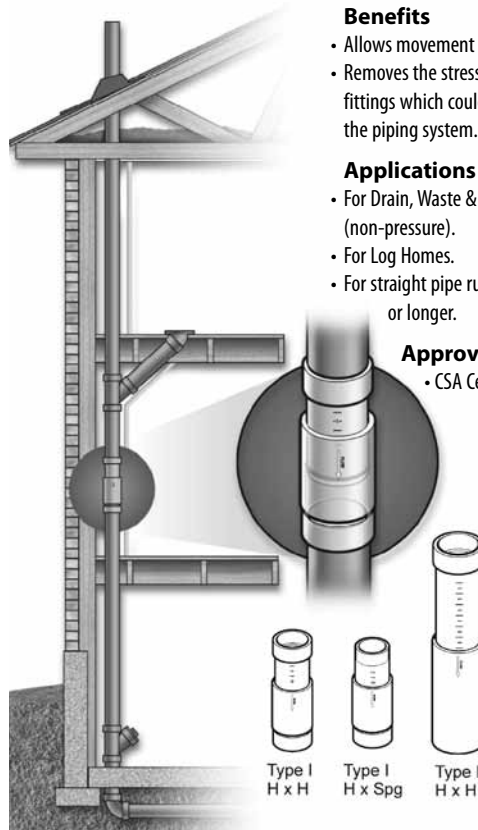

Installation Instructions

1. Locate unit (plunger side up). Preferably beneath lowest fixture.
2. Push plunger (inner section) until unit is fully closed.
3. Pull plunger back out specified distance according to temperature at time of installation.

Fahrenheit Degrees	Celsius Degrees	Distance
30	0	2.5" or 65mm
50	10	2.25" or 55mm
70	20	2" or 50 mm
85	30	1.75" or 45mm

Based on 20 feet (6 meters) installation.



PVC DWV FITTINGS

PRICE LIST U19-0119-IP JANUARY 2, 2019

PART #	PRODUCT CODE	PRICE CLASS	SKID QTY.	CTN. QTY.	SIZE	PRICE EACH
--------	--------------	-------------	-----------	-----------	------	------------

CAST IRON ADAPTERS

PVC ADAPTER, Cast Iron, (adapts PVC pipe to Cast Iron treaded connections) H x NPT



213467W	757150	C21	1200	25	3 x 3 1/2	See USP Price list
---------	--------	-----	------	----	-----------	--------------------

HUB ADAPTER, Cast Iron (Adapts DWV Spigot to Cast Iron Hub)

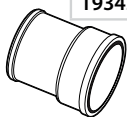

193452	755435	C19A	960	30	2	27.99
193454	755436	C19A	480	15	4	79.88
193464	755440	C19A	320	10	3 x 4 CI	60.56
193456	755437	C19A	216	12	6	208.67

NO HUB ADAPTER, Cast Iron (Adapts No Hub Elastomer Coupling to DWV Spigot) - H x Spg



193420	755425	C19A	7200	100	1 1/2	36.98
193422	755426	C19A	3600	50	2	14.78
193423	755427	C19A	2160	30	3	21.45
193424	755428	C19A	1080	15	4	27.54
193426	755429	C19A	256	8	6	96.89

ADAPTER COUPLINGS

ADAPTER COUPLING (Adapts Sewer & Drain to DWV) - H x H

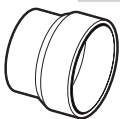

193036	755301	C19A	1200	25	4 x 3	39.02
193035	755300	C19A	360	20	6 x 4	109.02

ADAPTER BUSHINGS

ADAPTER COUPLING (Adapts Sewer & Drain to DWV) - H x H

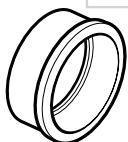

192842	755221	C19A	1600	50	4	16.87
192846	755222	C19A	450	25	6	58.74

PART #	PRODUCT CODE	PRICE CLASS	SKID QTY.	CTN. QTY.	SIZE	PRICE EACH
--------	--------------	-------------	-----------	-----------	------	------------

GRATES

DRAIN GRATE - Spg



193863	755540	C19A	3600	50	3	32.16
213863W	757274	C21	3600	50	3	See USP Price list
193864	755541	C19A	1800	25	4	35.85
213864W	757276	C21	1800	25	4	See USP Price list

TEST PLATES

TEST PLATE - Spg



ABS						
103761	751960	C10	-	100	1 1/2	See USP Price list
103762	751962	C10	-	100	2	See USP Price list
103763	751964	C10	14400	100	3	See USP Price list
103764	751966	C10	7200	100	4	See USP Price list
PVC						
193764	755529	C19A	7200	100	4	8.63

Visit our website for more information

- Specification Sheets
- E-Newsletter
- Price Lists

www.ipexna.com



APPROVALS:

Unless otherwise noted, products are approved / listed by NSF and IAPMO to standards that include:

NSF Standard 14



IAPMO IS5, PS 146



ASTM D2665, D1784, D3311



PVC DWV FITTINGS

INDEX

PRICE LIST U19-0119-IP JANUARY 2, 2019

PART#	Weight (Lbs.)	CARTON BARCODE	PG. #	PART#	Weight (Lbs.)	CARTON BARCODE	PG. #	PART#	Weight (Lbs.)	CARTON BARCODE	PG. #
103761	0.009	10662671108422	17	192263	1.495	10662671190137	7	192762	0.419	10662671192308	4
103762	0.018	10662671102932	17	192276	0.289	10662671190885	6	192766	2.026	30662671190872	4
103763	0.033	10662671102949	17	192277	0.403	10662671190144	6	192767	1.737	10662671190830	4
103764	0.071	10662671102956	17	192278	1.248	10662671190151	6	192768	3.505	-	4
109210-004	0.002	10662671103236	13	192279	2.231	10662671191608	6	192769	3.719	-	4
109210-005	0.004	10662671103243	13	192301L	0.397	10662671191943	6	192770	8.025	-	4
10TC315	0.02	10662671103267	5	192302L	0.602	10662671191837	6	192771	3.979	-	4
10TC316	0.026	10662671103274	5	192303L	1.889	10662671191233	6	192774	11.023	-	4
10TC318	0.053	10662671103281	5	192304L	3.194	10662671191981	6	192775	11.199	-	4
10TC320	0.077	10662671103298	5	192305	26.059	10622454263038	6	192801	0.079	10662671193282	13
10TC322	0.203	10662671109023	5	192306	7.119	10662671190748	6	192801A	0.115	10662671190304	13
192101	0.249	10662671192155	8	192307	41.002	-	6	192802	0.099	10662671192858	13
192102	0.362	10662671190014	8	192308	16.255	-	6	192804A	0.115	10662671193121	13
192104	2.595	-	8	192324	0.503	10662671191318	6	192806A	0.119	10662671193138	13
192105	25.126	-	8	192325L	0.481	10662671191851	6	192842	0.190	10662671192650	17
192106	5.904	-	7	192326L	1.270	10662671191301	6	192846	0.699	10662671192759	17
192107	38.129	-	8	192327L	2.489	10662671191974	6	192851	0.079	10662671193299	13
192108	13.757	-	8	192328L	1.905	10662671191998	6	192851A	0.112	10662671190311	11
192106A	10	-	11	192331L	1.087	10662671191868	6	192853A	0.112	10662671193107	11
192108A	8.001	-	11	192333	8.686	-	6	192855A	0.112	10662671193114	11
192114AS	0.313	10662671191950	11	192334	11.356	-	6	192860	0.082	10662671193145	4
192114S	0.256	10662671191967	11	192338	28.001	-	6	192860A	0.110	10662671190328	11
192115AS	0.507	10662671191806	11	192343	5.062	10662671191134	6	192861A	0.157	10662671193035	13
192115S	0.419	10662671191790	11	192344	5.170	10662671190755	6	192871	0.066	10662671192285	4
192116AS	1.226	10662671191820	11	192352	0.686	10662671192643	7	192872	0.104	10662671192292	4
192116S	1.043	10662671191813	11	192354	1.301	-	7	192873	0.397	10662671192506	4
192117AS	2.286	10662671192469	11	192355	5.807	-	7	192874	0.606	10662671192667	4
192117S	1.947	10662671191455	11	192356	11.949	-	7	192876	1.625	10662671191004	4
192118A	5.922	10662671190038	11	192401	0.179	10662671190212	5	192891	0.110	10662671191486	4
192124A	17.3	-	11	192402	0.295	10662671191400	5	192892	0.152	10662671191424	4
192126L	0.384	10662671191196	7	192403	0.866	10662671191349	5	192893	0.498	10662671191769	4
192127L	0.432	10662671191219	7	192404	1.462	10662671192165	5	192894	0.688	10662671192483	4
192128L	0.388	10662671191417	7	192405	11.001	10622454261126	5	192895A	10.02	10622454265971	4
192129	16.006	-	8	192406	3.422	10662671190823	5	192897A	16.028	10622454266008	4
192130L	1.060	10662671190045	7	192407	16.376	10622454260334	5	192896	2.039	-	4
192131	0.891	10662671192612	7	192408	6.367	-	5	192898	6.001	-	5
192134	1.402	10662671191561	7	192423	0.637	10662671190229	5	192898A	7.011	-	4
192136	1.887	10662671191547	7	192451L	0.218	10662671192117	6	192898T	17.031	-	11
192138	14.021	-	8	192452L	0.351	10662671191592	6	193001	0.084	10662671192209	4
192139	16.667	-	8	192453L	0.968	10662671191882	6	193001R	0.079	10662671192674	4
192140	19.039	-	8	192454L	1.764	10662671192001	6	193002	0.119	10662671190359	4
192141	20.018	-	8	192455	13.999	-	6	193002R	0.110	10662671192681	4
192142	25.038	10622454269566	8	192456	4.810	10662671190236	6	193003	0.454	10662671190366	4
192143	29.551	-	8	192457	21.001	-	6	193003R	0.441	10662671192698	4
192145	31.372	-	8	192458	11.177	-	6	193004	0.723	10662671192414	4
192144L	3.801	-	8	192501	0.192	10662671190243	5	193004R	2.425	10662671192704	4
192144	4.191	10662671190052	7	192502	0.311	10662671190250	5	193006	2.405	10662671190762	4
192147L	1.501	10662671192766	7	192503	0.866	10662671190267	5	193008	4.451	-	4
192147R	1.506	10662671192773	7	192504	1.539	10662671191622	5	193022	0.137	10662671191363	4
192148L	1.506	10662671191905	7	192505	15.062	-	5	193023	0.392	10662671192353	4
192148R	1.510	10662671191493	7	192506	3.459	10662671190861	5	193024	0.388	10662671190373	4
192151L	0.306	10662671191370	7	192507	22.648	-	5	193025	0.708	10662671192711	4
192152L	0.476	10662671190069	7	192508	6.625	-	5	193026	0.721	10662671191554	4
192153	1.442	10662671191165	7	192551	0.139	10662671191639	5	193035	1.814	10662671191110	17
192154L	2.811	10662671190076	7	192552	0.218	10662671191646	5	193036	0.481	10662671193312	17
192156	5.977	10662671190083	7	192553	0.606	10662671192360	5	193037	2.017	30662671191107	4
192157	8.73	-	8	192554	1.089	10662671192377	5	193038	5.754	-	4
192158	18.519	-	7	192556	2.970	10662671190816	5	193039	3.197	-	4
192181	1.001	10662671192056	8	192561	0.130	10662671191653	5	193051S	0.062	10662671192162	5
192184	1.768	10662671192063	8	192562	0.196	10662671191660	5	193052S	0.088	10662671192339	5
192185	3.263	10662671192841	8	192563	0.611	10662671192384	5	193053S	0.209	10662671192421	5
192186	0.692	10662671191752	8	192564	1.060	10662671192391	5	193054S	0.348	10662671191677	5
192187	0.439	10662671191523	8	192566	2.811	10662671190779	5	193057S	0.851	10662671190953	5
192188	0.467	10662671191530	8	192601	0.161	10662671191899	5	193062	0.055	10662671193183	5
192189	0.670	10662671192629	8	192602L	0.243	10662671192148	5	193063	0.157	10662671193046	5
192201	0.183	10662671192476	6	192603L	0.833	10662671192254	5	193064	0.293	10662671193053	5
192202	0.267	10662671192124	6	192604	1.398	10662671192087	5	193066	0.906	10662671190380	5
192203	0.882	10662671192346	6	192713	10.046	-	7	193081	0.084	10662671192247	5
192221	0.298	10662671192896	6	192715	14.78	-	7	193082	0.110	10662671192179	5
192223	1.314	10662671191462	16	192716	10.542	-	7	193083S	0.375	10662671192186	5
192245	1.122	10662671191776	6	192718	22.622	-	7	193084S	0.655	10662671192193	5
192248	1.080	10662671191936	6	192735	12.359	20622454261192	4	193085	6.001	10622454262833	5
192249	1.850	10662671192636	6	192736	6.001	10622454261935	4	193086	1.755	10662671190397	5
192251L	0.225	10662671191394	6	192737	8.142	10622454268897	4	193088	3.448	-	5
192252L	0.357	10662671190113	6	192738	16.469	10622454264677	4	193094	0.441	-	5
192253L	1.030	10662671190120	6	192739	17.461	30622454264695	4	193095	13.007	10622454265582	5
192254L	1.872	10662671192018	6	192740	12.798	50622454269175	4	193096	0.728	-	5
192255	20.157	-	6	192752	0.079	10662671190281	4	193097	14.991	10622454265599	5
192256	5.077	10662671190731	6	192754	0.384	10662671190298	4	193103	1.534	10662671192322	16
192257	31.231	-	6	192756	0.529	10662671191479	4	193103A	1.638	10662671192780	16
192258	8.953	-	6	192758	0.569	10662671191332	4	193201-S	0.346	10662671193169	11

PVC DWV FITTINGS

PRICE LIST U19-0119-IP JANUARY 2, 2019

PART#	Weight (Lbs.)	CARTON BARCODE	PG. #	PART#	Weight (Lbs.)	CARTON BARCODE	PG. #	PART#	Weight (Lbs.)	CARTON BARCODE	PG. #
193201AS	0.564	10662671192513	11	195128L	0.364	10662671191745	7				
193201S	0.527	10662671191684	11	195130L	0.888	10662671192926	7				
193202	0.880	10662671190403	11	195151L	0.289	10662671191387	7				
193202-1	0.582	10662671192803	11	195152L	0.467	10662671192537	7				
193203	2.586	10662671192315	11	195153	1.387	10662671191172	7				
193203-1	1.777	10662671191271	11	195154L	2.760	10662671190670	7				
193204	4.879	10662671192551	11	195156	5.906	10662671190915	7				
193204-1	3.276	10662671193152	11	195276	0.280	10662671192131	6				
193206	12.566	10662671063714	11	195277	0.399	10662671191189	6				
193206-1	7.756	10662671190410	11	195278	1.210	10662671192032	6				
193211-9	0.203	10662671058635	13	195326L	1.129	10662671193275	6				
193211N	0.569	10662671191691	11	195376	1.193	10662671190960	7				
193211Y	0.117	10662671190427	13	212107WAT	2.22	10662671214260	10				
193212E	0.891	10662671191295	11	212117AW	2.346	10662671214239	11				
193221A	0.633	10662671192865	11	212171AW	0.368	10662671210095	11				
193231A	0.723	10662671191066	12	212191AW	0.344	10662671210101	13				
193231E	0.635	10662671191073	12	212281AW	0.207	10662671210163	11				
193420	0.097	10662671190434	17	212286AW	0.192	10662671210170	11				
193422	0.174	10662671193060	17	212291AW	0.185	10662671210187	13				
193423	0.406	10662671192728	17	212321W	0.203	10662671210194	7				
193424	0.646	10662671192735	17	212332W	0.218	10662671210200	7				
193426	1.515	10662671190908	17	212333W	0.229	10662671214154	7				
193452	0.165	10662671193206	17	213627XWSSEO	0.732	10662671012002	14				
193454	0.880	10662671193220	17	213628MW	1.041	10662671210491	15				
193456	2.165	10662671190922	17	213628W	0.886	10662671210507	15				
193464	0.800	10662671193213	17	213628WSS	0.979	10662671210996	15				
193603	0.657	10662671191141	13	213631XW	0.728	10662671214147	13				
193604	0.708	10662671192261	13	213639WSS	1.111	10662671214178	15				
193611M	0.807	10662671191714	15	213660W	0.381	10662671212891	15				
193612M	0.882	10662671192872	15	213661W	0.412	10662671212907	15				
193614M	0.893	10662671191738	15	213663W	0.355	10662671213812	15				
193616M	0.858	10662671192599	15	213811AWBC	0.659	30662671190575	16				
193617M	1.082	10662671190465	15	213812AWBC	0.805	30662671190599	16				
193617SS	1.010	10662671190984	15	213813AWBC	1.883	30662671190612	16				
193624	0.761	10662671190489	15	213814AWBC	4.919	30662671190636	16				
193631	0.758	10662671190526	13	213863W	0.324	10662671214246	17				
193631T	0.747	10662671190519	13	213864W	0.529	10662671214253	17				
193631X	0.728	10662671191097	13	219180-002W	0.304	10662671210682	15				
193632	0.825	10662671192094	13								
193633	0.752	10662671192100	13								
193639M	1.184	10662671191240	15								
193639SS	1.005	10662671193008	15								
193644	1.030	10662671191158	15								
193701AS	0.141	10662671192889	4								
193701S	0.084	10662671191431	4								
193702AS	0.203	10662671192605	4								
193702S	0.115	10662671191448	4								
193703AS	0.567	10662671191929	4								
193703S	0.397	10662671191912	4								
193704AS	0.959	10662671192520	4								
193704S	0.619	10662671192278	4								
193705A	15.543	10622454265360	4								
193707A	2.055	10622454265377	4								
193708A	5.011	-	4								
193706AS	2.370	10662671191080	4								
193706S	1.519	10662671190847	4								
193723	1.991	10662671191509	4								
193724	3.389	10662671192049	4								
193726	7.09	-	4								
193750	0.908	10662671190854	8								
193764	0.104	10662671193343	17								
193863	0.324	10662671190649	17								
193864	0.529	10662671190656	17								
193930	0.026	10662671190717	13								
193931	0.031	10662671190724	13								
194149	0.571	10662671192070	7								
194153	1.005	10662671192933	7								
194154	2.498	10662671192919	7								
194155	2.601	10662671192834	7								
194301	0.478	10662671191783	7								
194302	0.743	10662671192452	7								
194303	2.304	10662671191844	7								
194304	4.239	10662671192490	7								
194317	0.509	10662671193268	7								
194320	0.547	10662671191875	7								
194326	1.032	10662671192025	7								
194327	1.354	10662671192407	7								
194337	1.887	10662671192544	7								
194338	3.078	10662671191516	7								
195126L	0.384	10662671191226	7								
195127L	0.421	10662671191202	7								

PVC DWV FITTINGS



Eastern U.S. Customers

Tel: (289) 881-0120

Toll Free: 1-800-463-9572

Fax: (905) 844-0826

Orders66@ipexamerica.com

Western U.S. Customers

Tel: (303) 373-1918

Toll Free: 1-888-461-5307

Fax: (303) 373-1923

Orders43@ipexamerica.com

www.ipexna.com | sales@ipexamerica.com

IPEX Distribution Centers

Cincinnati, OH

Denver, CO

Salt Lake City, UT

Foothill Ranch, CA

Barrie, ON