

### Features

- Geometric rectangular basin with vertical sides.
- Overflow drain.

### Material

- Vitreous china.

### Installation

- No faucet holes; requires wall- or counter-mount faucet.
- Undermount.

### Recommended Products/Accessories

K-8998 P-Trap  
K-23726 Drain treatment  
K-23725 Cast iron cleaner

### Included Components

Additional Components:  
1193643 Basin clamps



ADA

### Codes/Standards











ASME A112.19.2/CSA B45.1  
ADA  
ICC/ANSI A117.1

### KOHLER® One-Year Limited Warranty

See website for detailed warranty information.

### Available Colors/Finishes

*Color tiles intended for reference only.*

Color	Code	Description
	0	White
	HW1	Honed White
	96	Biscuit
	47	Almond
	NY	Dune
	95	Ice™ Grey
	G9	Sandbar
	33	Mexican Sand™
	K4	Cashmere
	58	Thunder™ Grey
	7	Black Black™

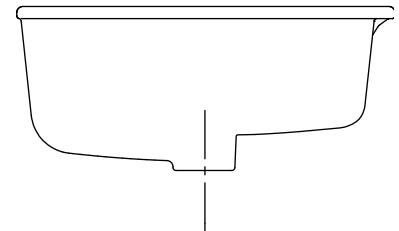
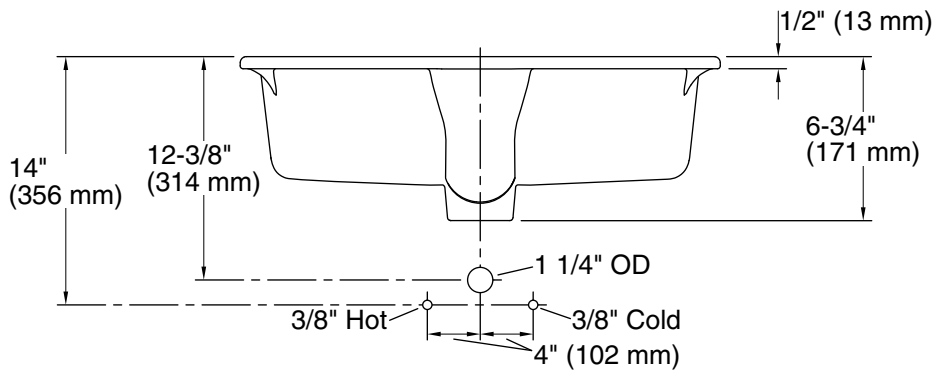
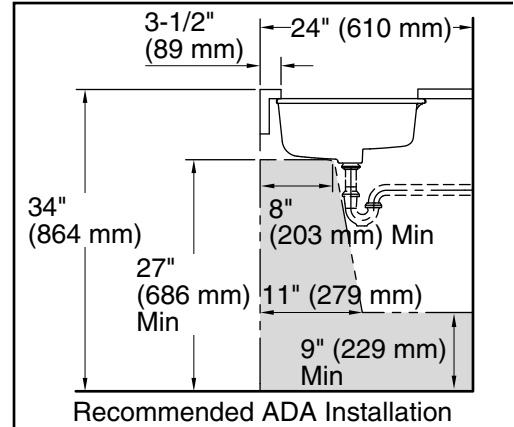
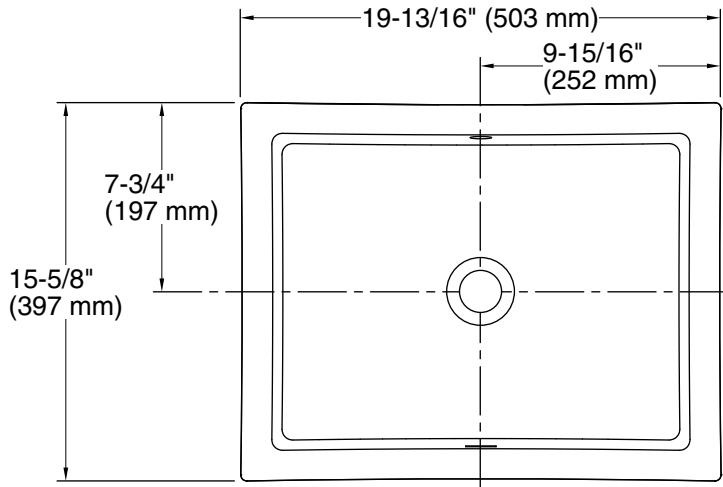

### Technical Information

All product dimensions are nominal.

- Bowl configuration: Single
- Installation: Under-mount
- Bowl area (Only): Length: 17-1/4" (438 mm)  
Width: 13" (330 mm)  
Water depth: 3-1/8" (79 mm)
- Drain hole: 1-3/4" (44 mm)
- Template: 1109226-7, required, not included

### Notes

Install this product according to the installation instructions.

**NOTICE:** Countertop manufacturer or cutter must use the current product template available at [www.kohler.com](http://www.kohler.com), or by calling 1-800-4KOHLER. Kohler Co. is not responsible for cutout errors when the incorrect cutout template is used.

ADA compliant when installed to the specific requirements of these regulations.