

INSTALLATION INSTRUCTIONS

Ventilating Fan

Model No. FV-08VRE2

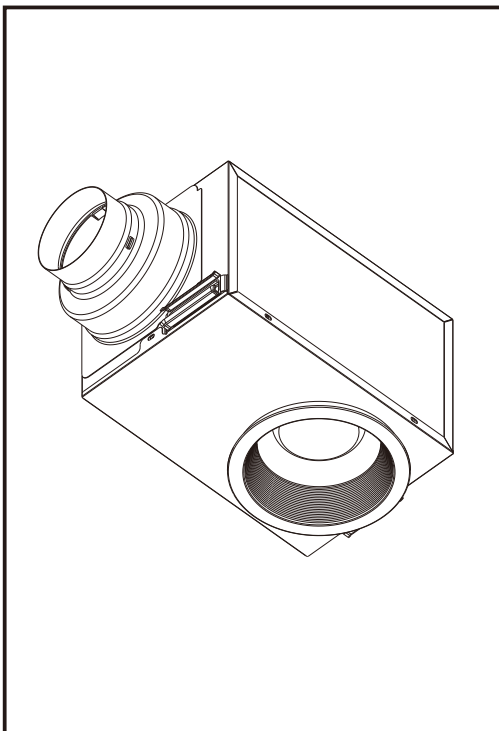

CONTENTS

GENERAL SAFETY INFORMATION	2~3
DESCRIPTION	3~4
UNPACKING	4
SUPPLIED ACCESSORIES	4
DIMENSIONS	4
WIRING DIAGRAM	5
INSTALLATION (BETWEEN JOISTS MOUNTING)	5~7
MAINTENANCE (CLEANING)	7
MAINTENANCE (REPLACEMENT OF LED LAMP)	7
PRACTICAL GUIDE TO INSTALLATION	BACK COVER
SPECIFICATIONS	BACK COVER
COMPATIBLE DIMMERS (NOT SUPPLIED)	BACK COVER
PRODUCT SERVICE	BACK COVER

READ AND SAVE THESE INSTRUCTIONS

Thank you for purchasing this Panasonic product.

Please read these instructions carefully before attempting to install, operate or service the Panasonic product. Failure to comply with instructions could result in personal injury or property damage.

Please explain to users how to operate and maintain the product after the installation, and this booklet should be presented to users.

Please retain this booklet for future reference.



GENERAL SAFETY INFORMATION

For your safety





To reduce the risk of injury, loss of life, electric shock, fire, malfunction, and damage to equipment or property, always observe the following safety precautions.

Explanation of symbol word panels

The following symbol word panels are used to classify and describe the level of hazard, injury, and property damage caused when the denotation is disregarded and improper use is performed.















 WARNING	Denotes a potential hazard that could result in death or serious injury.
 CAUTION	Denotes a hazard that could result in minor injury.

The following symbols are used to classify and describe the type of instructions to be observed.

	This symbol is used to alert users to a specific operating procedure that must not be performed.
	This symbol is used to alert users to a specific operating procedure that must be followed in order to operate the unit safely.
	This symbol is used to alert users not to disassemble the equipment.
	This symbol is used to alert users to make sure of grounding when using the equipment with the grounding terminal.

WARNING

To reduce the risk of fire, electric shock or injury to persons, observe the following:













-  Use this unit only in the manner intended by the manufacturer. If you have any questions, contact the manufacturer.
-  Before servicing or cleaning unit, switch power off at service panel and lock the service disconnecting means to prevent power from being switched on accidentally. When the service disconnecting means cannot be locked, securely fasten a prominent warning device, such as a tag, to the service panel.
-  Installation work and electrical wiring must be done by qualified person(s) in accordance with all applicable codes and standards, including fire-rated construction.
-  Sufficient air is needed for proper combustion and exhausting of gases through the flue (chimney) of fuel burning equipment to prevent back drafting. Follow the heating equipment manufacturer's guideline and safety standards such as those published by the National Fire Protection Association (NFPA), and the American Society for Heating, Refrigeration and Air Conditioning Engineers (ASHRAE) and the local code authorities.
-  When cutting or drilling into wall or ceiling, do not damage electrical wiring and other hidden utilities.
-  Ducted fans must always be vented to the outdoors.
-  If this unit is to be installed over a tub or shower, it must be marked as appropriate for the application and be connected to a GFCI (Ground Fault Circuit Interrupter) - protected branch circuit.
-  These models are UL listed for tub and shower enclosures.
-  Do not use this fan with any solid-state speed control device. Solid state controls may cause harmonic distortion which can cause motor humming noise.
-  Canada only: Not to be installed in a ceiling thermally insulated to a value greater than R40.
-  Do not disassemble the unit for reconstruction. It may cause fire or electric shock.
-  When this product is no longer being operated, please remove the product to prevent the possibility of falling.
-  Ceiling joist must be subjected to static load more than five times the weight of the product.
-  Do not install with a method which is not approved in the instructions.

GENERAL SAFETY INFORMATION CONTINUED

WARNING

 This product must be properly grounded.

CAUTION

-  Do not install this ventilating fan where interior room temperature may exceed 104 °F (40 °C).
-  Make sure that the electric service supply voltage is AC 120 V, 60 HZ.
-  Follow all local electrical and safety codes, as well as the National Electrical Code (NEC) and the Occupation Safety and Health Act (OSHA).
-  Always disconnect the power source before working on or near the fan, motor, light fixture or junction box.
-  Protect the supply wiring from sharp edges, oil, grease, hot surfaces, chemicals or other objects.
-  Do not kink the supply wiring.
-  Provide make up air for proper ventilation.
-  For general ventilating use only. Do not use to exhaust hazardous or explosive materials and vapors.
-  Do not install the unit where ducts are configured as shown in Fig A.
-  Not for use in cooking area. (Fig B)
-  The special-purpose or dedicated parts, such as mounting fixtures, must be used if such parts are provided.
-  The product must use LED lamp (model: 11BR30G4DIM/927/GU24) from the company Green Creative.
-  Please wear gloves when installing or cleaning the fan.

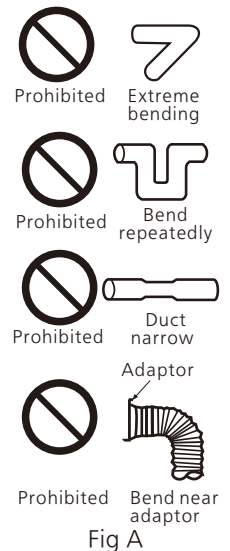

Fig A

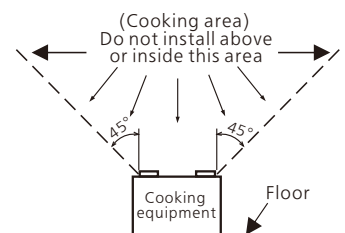

Fig B

DESCRIPTION

This Panasonic ventilating fan model is listed by UL under UL file No. E78414.

This product uses a sirocco fan driven by a capacitor motor.

The motor is designed to have an extended service life with reduced energy consumption.

It also incorporates a thermal-cut off for safety. The trim ring is a spring-loaded, quick remove type. A damper for preventing air counterflow is provided. The blower uses a high-capacity sirocco fan developed to reduce the noise level.

The lighting unit is an energy-saving, lighting device that uses one 11 W BR30 shape LED lamp (model: 11BR30G4DIM/927/GU24, from the company Green Creative) and produces almost the same illumination as a standard 65 W incandescent lamp.

FCC Note: This equipment has been tested and found to comply with the limits for a Class B digital device, pursuant to Part 15 of the FCC Rules. These limits are designed to provide reasonable protection against harmful interference in a residential installation. This equipment generates, uses and can radiate radio frequency energy and, if not installed and used in accordance with the instructions, may cause harmful interference to radio communications. However, there is no guarantee that interference will not occur in a particular installation. If this equipment does cause harmful interference to radio or television reception, which can be determined by turning this product on and off, the user is encouraged to try to correct the interference by one of the following measures:

- Reorient or relocate the receiving antenna.
- Increase the separation between the equipment and receiver.
- Connect equipment into outlet on a circuit different from that to which the receiver is connected.
- Consult the dealer or an experienced radio/TV technician for help.

DESCRIPTION CONTINUED

Warning: This equipment must be installed by qualified person in accordance with the provided installation instructions; and all applicable codes and standards. Also, any changes or modifications not expressly approved by the party responsible for compliance could void the user's authority to operate this equipment.

Responsible Party: Panasonic Corporation of North America
Two Riverfront Plaza, Newark, NJ 07102

Customer Support: 1-866-292-7299

This device complies with Part 15 of the FCC Rules. Operation is subject to the following two conditions: (1) This device may not cause harmful interference, and (2) this device must accept any interference received, including interference that may cause undesired operation.

This product may be used with optional dimmer switch in accordance with dimmer switch instruction instructions.





Risk of Fire: Type IC-Inherently Protected, Only Use LED Lamp , Max 11W, Type GU24.





UNPACKING

Unpack and carefully remove the unit from carton.

Refer to the Supplied Accessories list to verify that all parts are present.

SUPPLIED ACCESSORIES

Part name	Appearance	Quantity
Trim ring		1
Suspension bracket I		2
Suspension bracket II		2
11 W LED lamp (model: 11BR30G 4DIM/927/GU24)		1

Part name	Appearance	Quantity
Screw I (ST4.2X6)		2
Screw II (ST4.2X18)		2
long screw (ST4.2X20)		8
Installation instructions		2
Warranty sheet		1

DIMENSIONS

Unit: inches (mm)

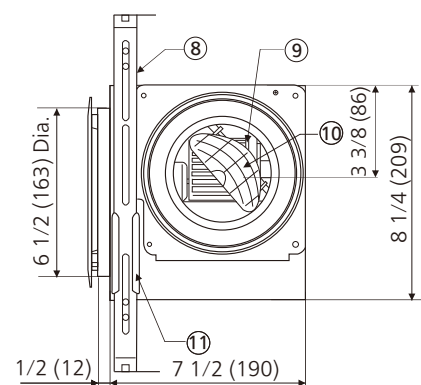
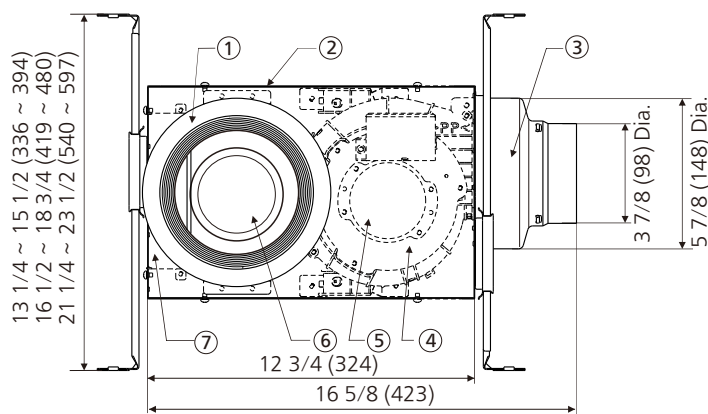

No.	Part name	No.	Part name
①	Trim ring	⑦	Junction box
②	Fan body	⑧	Suspension bracket
③	Adaptor	⑨	Fan
④	Blower unit	⑩	Damper
⑤	Motor	⑪	Bracket cover
⑥	LED lamp		

WIRING DIAGRAM

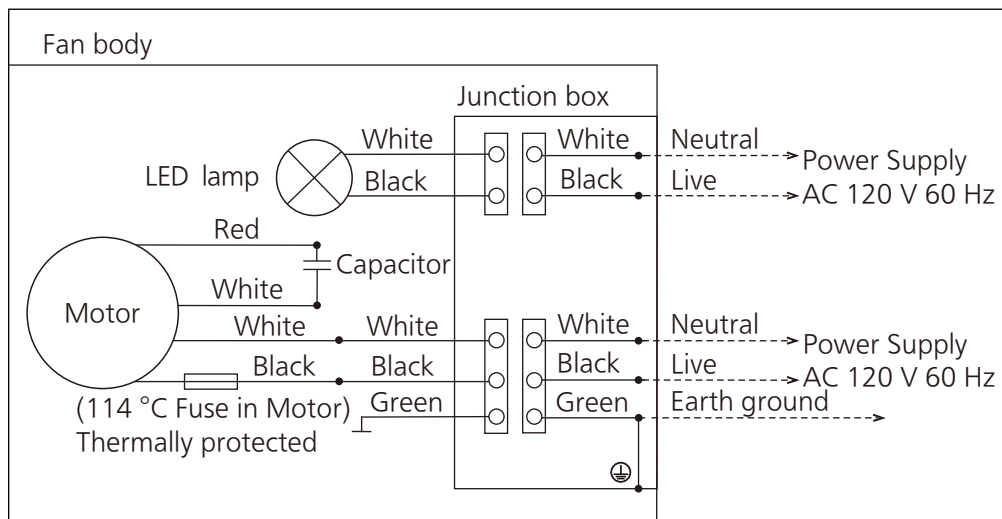

INSTALLATION (BETWEEN JOISTS MOUNTING)

IMPORTANT

Remove the tape from damper and adaptor before installation. As shown below:

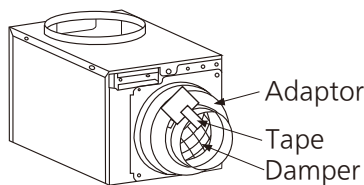

Joist situation:

Spacing A is 12 inches (305mm) to 24 inches (609mm) on center joists

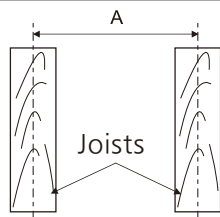

Unit: inches (mm)

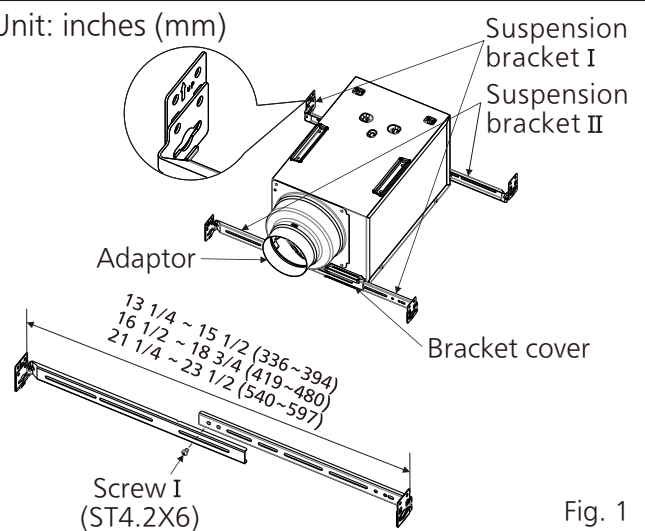
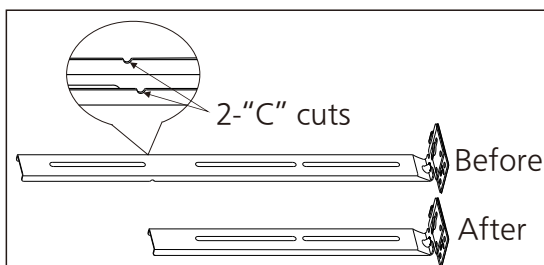

Fig. 1

Please follow the installation steps as below:

1. Insert the suspension brackets into the fan body from each side of the bracket cover. (Fig. 1)

If spacing A between center joists is 12 inches, cut all suspension brackets along the two "C" cuts with a hacksaw or other tools.



2. Fix suspension brackets I and II with screws I (ST4.2X6), but remember not to tighten the screws up yet. (Except that the spacing is 12 inches between joists.) (Fig. 1)
3. Position the fan body between joists, and hold it properly. Mark the long holes of all the four suspension brackets on joists. (Fig. 2)
4. Fix four long screws (ST4.2X20) partially into joists at the four marked locations. (Fig. 3)

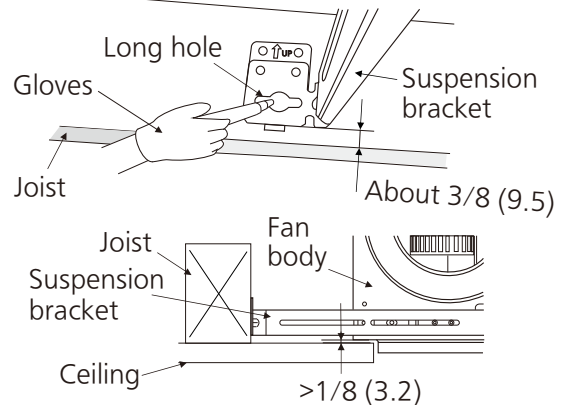

Unit: inches (mm)

Fig. 2

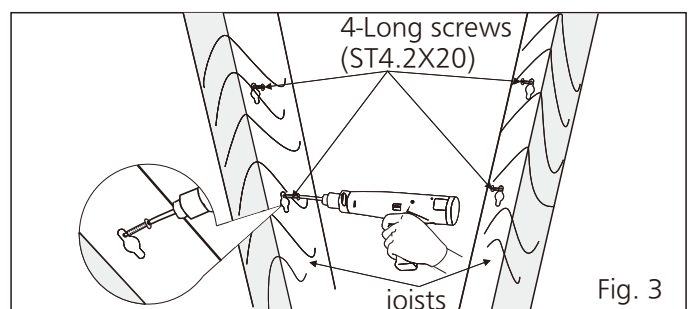

Fig. 3

INSTALLATION (BETWEEN JOISTS MOUNTING) CONTINUED

5. Hang the fan body down from the four long screws, and adjust the suspension brackets if necessary. Then, tighten the four long screws up. And that, fix the other four long screws (ST4.2X20) to other holes. Make sure the fan body is level and square with the joists. (Fig. 4)
6. Tighten the two screws I (ST4.2X6) up (Except that the spacing is 12 inches between joists.). Then secure suspension bracket I and II to the fan body with screws II (ST4.2X18). (Fig. 4)
7. Remove the knock-out hole from the junction box cover, and remove the junction box cover. Then secure the conduit or stress relief to the junction box knock-out hole. (Fig. 5)
8. Refer to wiring diagram (Page 5). Follow all the local electrical safety codes as well as the National Electrical Code (NEC). Using UL approved wire nuts, connect house power wire to ventilating fan wires. (Fig.5)
9. Mount back the junction box cover.

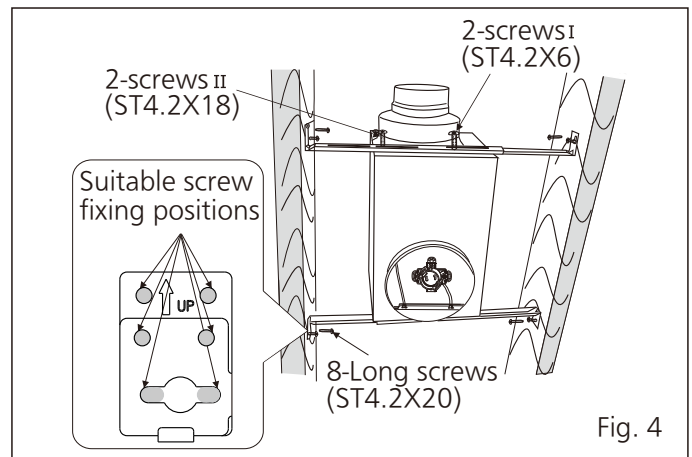

Fig. 4

7. Remove the knock-out hole from the junction box cover, and remove the junction box cover. Then secure the conduit or stress relief to the junction box knock-out hole. (Fig. 5)
8. Refer to wiring diagram (Page 5). Follow all the local electrical safety codes as well as the National Electrical Code (NEC). Using UL approved wire nuts, connect house power wire to ventilating fan wires. (Fig.5)
9. Mount back the junction box cover.

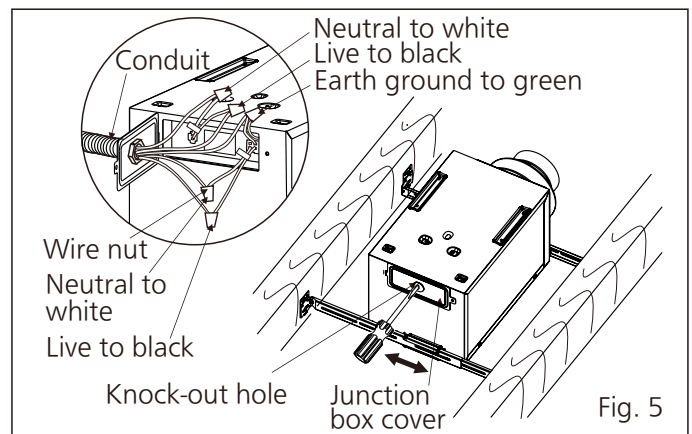



Fig. 5

CAUTION

9. Mount back the junction box cover.
-  Mount junction box cover carefully so that lead wires are not pinched.

10. Install a circular duct and secure it with clamps or wire ties, and seal it with mastic or approved foil tape. A 4 or 6-inch circular duct is needed to connect to the relevant part of adaptor. (Fig. 6)

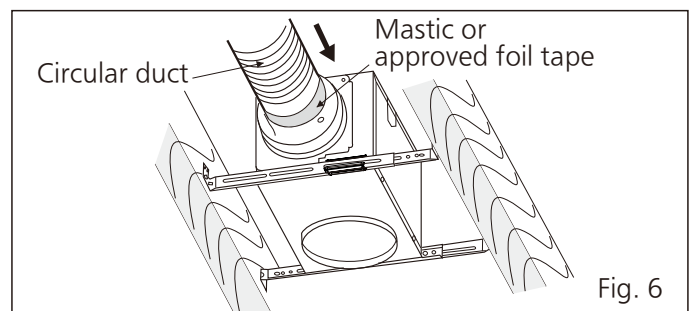

Fig. 6

11. Finish ceiling work. A circle ceiling hole (6 1/2 inches (165mm) dia.) should be cut. And make sure there will be a gap (>1/8 inches (3.2mm)) between bottom of fan body and ceiling. (Fig. 7)

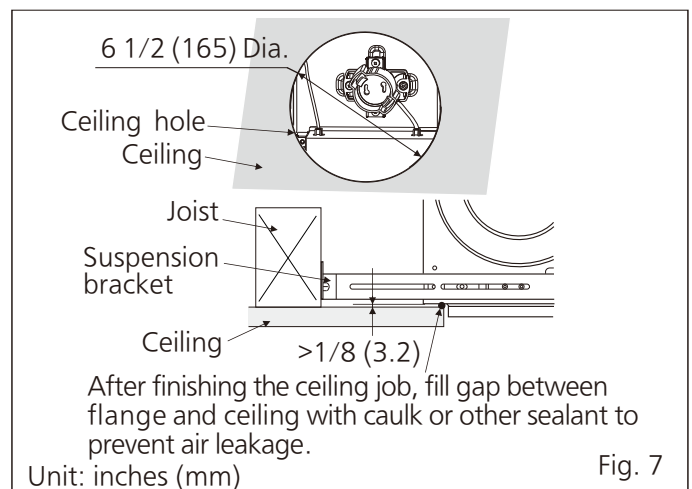



Fig. 7

12. Install the supplied LED lamp. (Fig. 8)

CAUTION

12. Install the supplied LED lamp. (Fig. 8)
-  Use other lamp may result in poor performance or risk of fire.
-  The supplied LED lamp is not intended for other use.

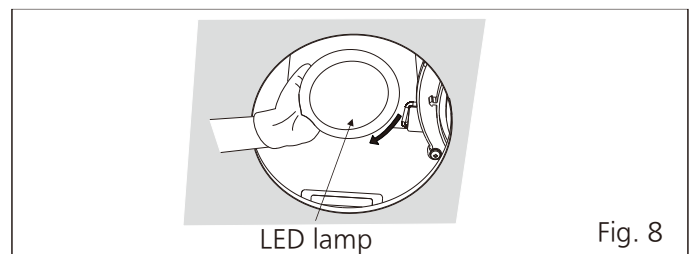
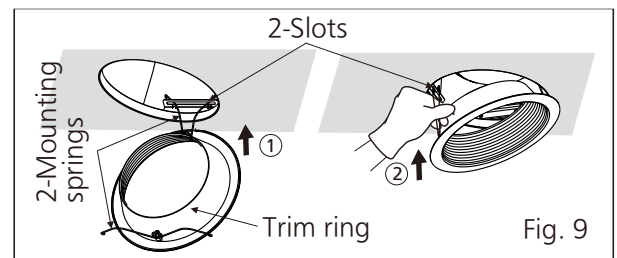

Fig. 8

INSTALLATION (BETWEEN JOISTS MOUNTING) CONTINUED

13. Insert the mounting springs into the slot as shown in the figure and attach the trim ring to the fan body. (Fig. 9)



MAINTENANCE (CLEANING)

! WARNING

- ! Disconnect power source before working on unit. Routine maintenance must be done every year.

! CAUTION

- ! Never use gasoline, benzene, thinner or any other such chemicals for cleaning the ventilating fan.
- ⊘ Do not immerse motor in water when cleaning.
- ⊘ Do not soak resin parts in water over 140 °F (60 °C).

1. Remove the trim ring by pulling down the mounting springs. (Squeeze mounting spring and pull down carefully.) (Fig. 10)
2. Clean the trim ring. (Don't put into hot water. Use non-abrasive kitchen detergent, wipe dry with clean cloth.) (Fig. 11)
3. Dry the trim ring after cleaning.
4. Remove dust and dirt from fan body using a vacuum cleaner. (Fig. 12)
5. Using a cloth dampened with kitchen detergent, remove any dirt from fan body. Wipe dry with clean cloth. (Fig. 13)
6. Replace the trim ring. (Fig. 9)

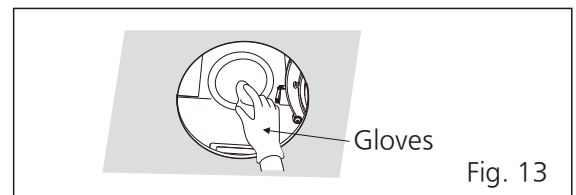
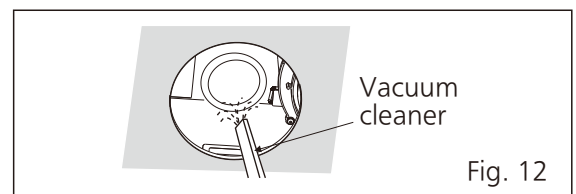
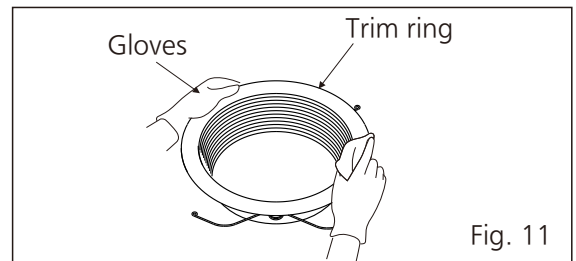
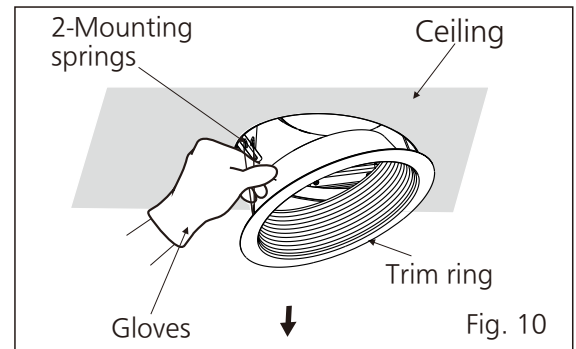

MAINTENANCE (REPLACEMENT OF LED LAMP)

! WARNING

- ! Disconnect power source before working on unit.
- ! This is a GU24 type lamp base and the lamp is fragile and heavy. Please handle with care.
- ! Make sure the temperature of lens and lighting unit has cooled down before maintenance (cleaning) or replacement of lamp.

1. Remove the trim ring by pulling down mounting springs. (Squeeze mounting spring and pull down carefully.) (Fig. 10)
2. Remove the LED lamp. (Fig. 14)
3. Replace the 11 W BR30 shape LED lamp (model: 11BR30G4DIM/927/GU24, from the company Green Creative). (Fig. 8 of page 6)
4. Replace the trim ring. (Fig. 9)

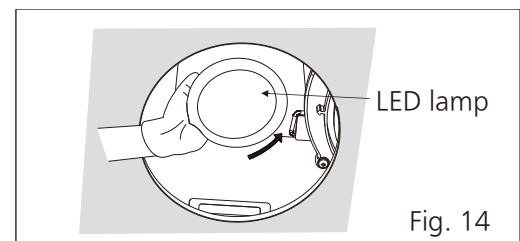

PRACTICAL GUIDE TO INSTALLATION

Properly insulate the area around the fan to minimize building heat loss and gain. (Fig. 15) Loose fill or batt insulation can be placed directly over the fan housing in the attic. Our fans and fan/light combination units do not create excessive heat that is a common problem with recessed light fixtures or some competitor's fan/light combination. Our efficient, cool-running motors and our LED lamp do not create enough ambient heat to be subjected to these limitations.

The ducting from this fan to the outside of the building has a strong effect on the air flow, noise and energy use of the fan. Use the shortest, straightest duct routing possible for best performance, and avoid installing the fan with smaller ducts than recommended. Insulation around the ducts can reduce energy loss and inhibit mold growth. Fans installed with existing ducts may not achieve their rated air flow.

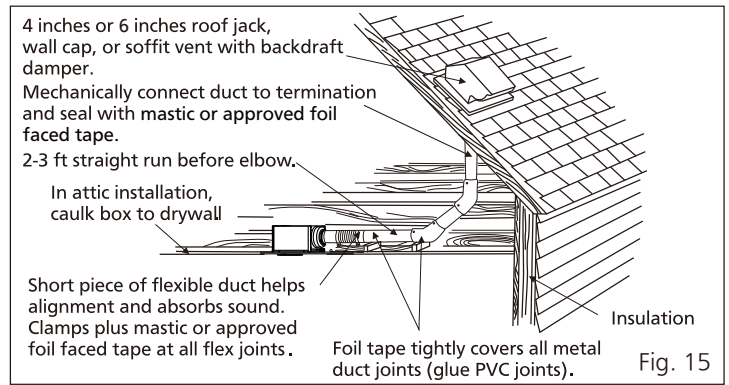

SPECIFICATIONS

Model No.	Air direction	Voltage (V)	Frequency (Hz)	Duct diameter (inches)	Noise at 0.1"WG (sones)	Power consumption (W)		Speed at 0.1"WG (rpm)	Air volume at 0.1"WG (CFM)	Weight lb. (kg)
						Fan	Lamp			
FV-08VRE2	Exhaust	120	60	4	1.0	18.5	11.0	1340	80	8.6(3.9)
				6	1.0	18.5	11.0	1340	80	

HVI Certified performance based on HVI Procedures 915, 916 and 920.

COMPATIBLE DIMMERS (NOT SUPPLIED)

If you want to connect a dimmer, please get the suitable dimmer's information from the website which is written on the lamp's packaging.

PRODUCT SERVICE

Warning Concerning Removal of Covers.

The unit should be serviced by qualified technicians only.

Your product is designed and manufactured to ensure a minimum of maintenance.

Should your unit require service or parts, call Panasonic Call Center at 1-866-292-7299 (USA) or 1-800-669-5165 (Canada).

Panasonic Corporation of North America

Two Riverfront Plaza, Newark, NJ 07102
www.panasonic.com

Panasonic Canada Inc.

5770 Ambler Drive, Mississauga, Ontario L4W 2T3
www.panasonic.ca

© Panasonic Corporation 2016

Printed in China

P0916 08VRE2421