

# **SUPER** STEALTH

## **Installation Manual**



The STEALTH 360 is the most reliable and technically advanced motion-activated light control ever produced. This technical manual is written for electrical professionals who wish to maximize the performance and reliability of this superb sensor.

RAB welcomes your questions or comments.  
Please call 888 722 1000 or email [marketing@rabweb.com](mailto:marketing@rabweb.com).  
*Thank you for purchasing a RAB sensor.*



STL360HBW



STL360H



STL3FFLED18

## Specifications:

Switching Capacity:	8 amps 1000 watts incandescent 250 watts fluorescent
Voltage:	120 volts
Protection Pattern:	180° forward 360° below and to the sides
Time Adjustment:	5 seconds to 12 minutes
Power Consumption:	1 watt
Surge protection:	6000 volts

## Cautions:

TURN OFF ALL POWER AT CIRCUIT BREAKER/FUSE PANEL

- Read entire Installation Manual before proceeding.
  - All wiring should comply with local electrical codes and requires a qualified electrician.
  - The total lighting load connected to STL360 must not exceed (1000 watts incandescent, 250 watts fluorescent). To switch more wattage, an electrician can install a relay.
  - Line Carrier Remote Control Systems such as X-10, Leviton or Radio Shack are incompatible with sensors and may cause false activations.
  - Do not install sensors on a circuit that feeds motor loads such as kitchen appliances, HVAC equipment, washer/dryer, or garage door openers.
  - Sensor functions best when the direction of expected movement is across its detection pattern, not towards the sensor.
- Mount 6'-10' high for optimum range and detection.

## How Does the Super Stealth 360 Work?

The STL360's infrared sensor "sees" temperature changes caused by the motion of people or cars within its protection zone and turns on lights automatically. It welcomes visitors and may deter intruders.

### Total coverage. Two sensors in one.

Two powerful detectors combine to give the STL360 "Can't Miss" Detection: 180° long forward range (180° x 60') plus superb 360° detection below and to all sides.



### How do the scanning LED detection indicators work?

Scanning LEDs serve as a deterrent by indicating a security device in operation. They also show the STL360's mode of operation.

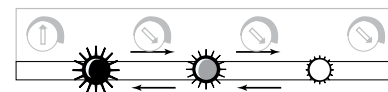

"On Guard Auto Mode"  
LEDs scan continuously back & forth

Automatic Mode: When the STL360 is "On Guard" in Auto mode, three red LEDs scan continuously day and night, except during detections (at which time the controlled lights will go on and LEDs will be off).



"Test Mode" all LEDs off

**Test Mode:** When the sensor is in "Test Mode" all of the LEDs will be off.

### Manual Override Mode:

When the sensor is ready for "Manual Override Mode" the middle LED will be on steady.



Middle LED on **steady** is  
Manual Override Mode  
Middle LED **blinking** is  
Evening Timer Mode

### Evening Timer Mode:

When the sensor is ready for "Evening Timer Mode" the middle LED will blink.

### How long do the lights stay on?

Lights remain on as long as there is movement within the protection zone. Once the zone is vacated lights can be adjusted to remain on approximately 5 seconds up to 12 minutes. Since the lights are on only when needed, and the sensor uses only one watt. The Stealth is extremely energy efficient.

### Can outdoor lights still be turned on with the light switch?

Yes. STL360 can be controlled by a conventional indoor switch or circuit breaker. STL360 operates in the auto mode unless changed. Lights can be turned on or off manually at night only with the Manual Override Mode..

### Wall Switch Manual Override: (to keep lights on)

Flip the switch twice slowly (off-on-off-on) within 1-2 seconds. If you set this during the sensor will become "ready" for the Manual Override Mode and will start Manual Override at dusk.

**Evening Timer:** (to keep lights on, and is repeated every night): Flip the switch three times slowly (off-on-off-on-off-on) within 1½ - 3 seconds. You can set this during the day and the Evening Timer Mode will begin at dusk.

### To Resume Automatic Mode:

Switch power off for at least 10 seconds, then back on.

### Will STL360 detect animals?

STL360 may detect large animals. Having animals trigger the sensor can give property a "lived-in" look. However, you can limit animal detection by turning down the sensitivity knob and/or placing the blinders provided on the lower part of the forward lens.

### How do you make adjustments to the sensor?

Use the adjustment tool provided, or a screwdriver with a 1/8" wide blade, to adjust the controls on the front of the sensor. (see page 11-12)

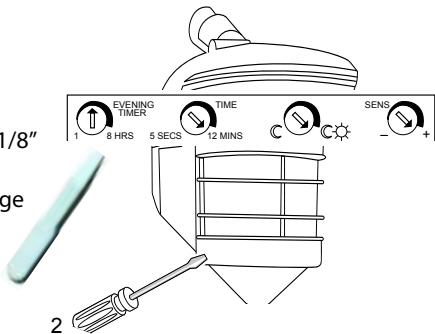

### Choosing a Location

The best location is where the sensor can "see" all paths of movement. The sensor may be wall or soffit mounted.

As distance from the sensor increases, larger movement will be required for detection. For instance, at 10 feet, a half step will be enough, while at 50 feet several steps will be necessary for detection.

### How large an area does STL360 protect?

Two powerful detectors combine to give the STL360 180°x60' long forward range plus superb 360° downward detection below and to all sides.

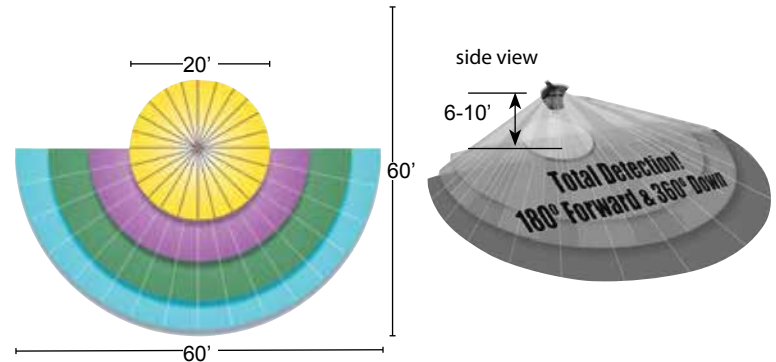

### Mounting Height

Mounting at 6-10' above the ground allows maximum range. If the sensor is mounted above 15' high, the usable range is reduced.

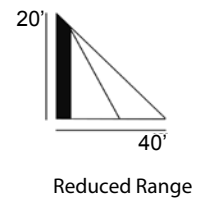
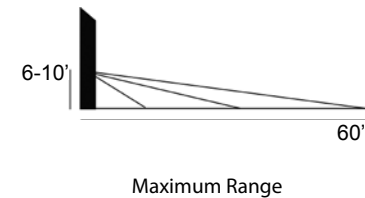

### Difficult Locations:

Sensor may be triggered by unwanted movement or heat source, such as a swaying tree, road traffic, dryer vent, swimming pool or hot tub.

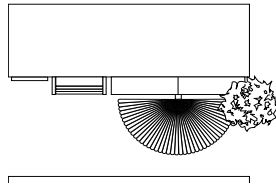

### To improve performance in difficult locations:

- Reduce sensitivity by turning the SENS knob counterclockwise

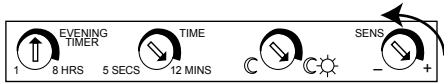

and/or...

- Mask lens in the direction of the unwanted movement or heat source using the lens mask provided or opaque tape.

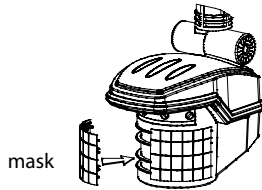

### Mounting Stability

- Mount sensor on stable surface. Do not mount on a tree or pole that will move in the wind.

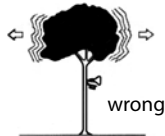

### Light vs. Sensor Position

- Make sure sensor and lights are mounted firmly. If they move when touched, tighten all screws.
- Make sure heat from lights is not triggering sensor. Sensor must be located below and as far away as possible from its lights.



## Choosing a Location

### Locations Near Roads

Cars and passing traffic may activate the sensor if it is aimed at the road.

### To Improve Performance in Difficult Locations:

- Reduce sensitivity by turning the SENS knob counterclockwise,

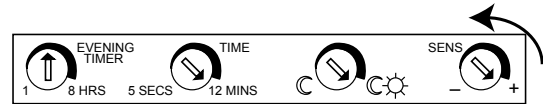

- Mask lens in the direction of the traffic using the lens mask provided or opaque tape. (Lens Mask can be broken along lines to desired size)

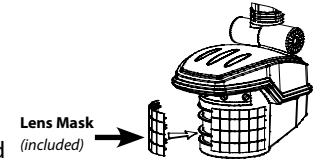

- Make sure that sensor is not aimed at traffic. The sensor should be aimed down so that the maximum range of the sensor ends at least 20' from the road. This will avoid detection of passing trucks and cars, or the air currents they create.

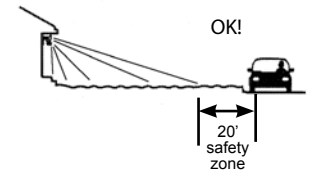

### Mount Level

The sensor should be mounted level from side to side and pointed at the area where you desire coverage. If tilted, part of the detection zone may be high in the air over people's heads.

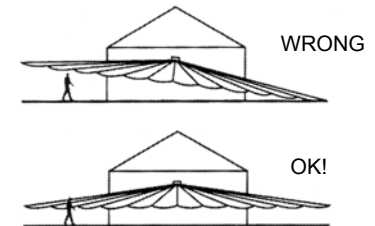

### Locate for Movement Across Pattern

Check that movement is not directly towards sensor. Sensor will see movement ACROSS its pattern move quickly. Check that movement far away and directly towards sensor is not entirely within one zone. To fix, change the sensor angle or location.

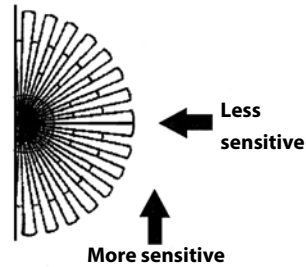

If the sensor is located over a pathway so all movement is directly toward it, range may appear limited. "Micro Adjust" sensor by moving sideways 1/4" or so, which may reposition the zones enough to allow earlier detection.



Better detection after "micro adjustment"



### Choose a Protected Location

Mount sensor in protected area. The more protected the mounting location, the less chance of lights turning on occasionally during rain, snow and windstorms. This could happen because the sensor is detecting dramatic changes in temperature.

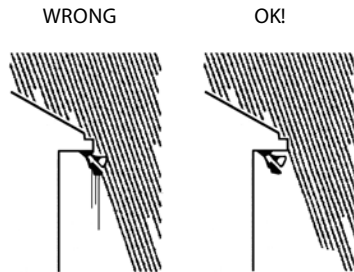

## STL360 Kit Assembly and Wiring



STL360H



STL360HBW

STL360 floodlight kits come pre-wired and assemble on the RAB CU4 EZ plate, allowing for mounting on round, rectangular or octagonal surface or recessed boxes.

### Mounting

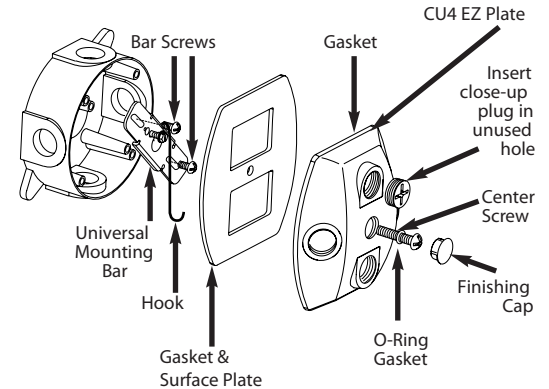

### Wiring

Red pigtail is only used to switch remote or additional fixtures.

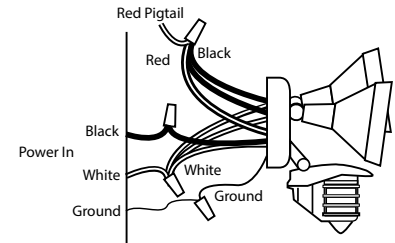

## STL360 Assembly and Wiring

1. Attach the Universal Mounting bar with the screws provided to the junction box. If you are attaching your STL360 kit to a surface mount weatherproof box, you must use with the metal mounting plate with gasket.

### 2. Easy Wiring Tip:

Use the "S" shaped Hands Free Hanging Hook to hold the CU4 EZ Plate during wiring.

3. Bring power leads and sensor kit leads through holes in gasket and plate into junction box.

4. Strip 1/2" of insulation from all leads.

5. Attach ground wire(s) to junction box grounding screw. Connect as shown in wiring diagram on page 7.

6. Twist on wire nuts. Secure with electrical tape.

7. Align CU4 EZ Plate and metal surface plate with gasket (for use with surface mounted junction boxes) to ensure proper seal. Tighten CU4 EZ Plate center screw (make sure O-Ring gasket is on the screw) to attach CU4 EZ Plate to the box.

8. Insert plastic Finishing Cap in the center of the CU4 EZ Plate for a weatherproof seal.

9. Use silicone sealant around plate and all opening to ensure a weather proof seal. Seal all unused conduit entries on surface junction box.

10. Screw in light bulbs. Turn on power. Conduct walk test to adjust sensor response (see page 15).

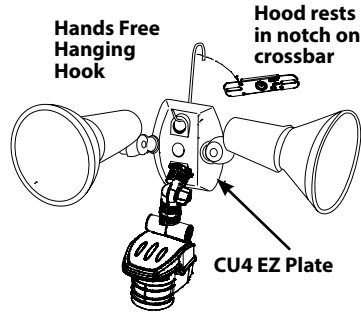

- To install a STL360 Sensor with separately purchased floodlights, start at #1

- To install STL360 Pre-wired Floodlight Kits, see page 7.

1. Screw the threaded arms of each floodlight into the RAB CU4 EZ Plate. (See diagram on page 7)
2. Screw the threaded arm of the sensor into the bottom hole of the CU4 EZ Plate. Sensor should be below and as far away from the floodlights as possible.

3. Attach the Universal Mounting bar with the screws provided to the junction box. If you are attaching your STL360 kit to a surface mount weatherproof box, you must use the metal mounting plate with gasket.

4. Use the "S" shaped Hands Free Hanging Hook to hold the EZ Plate during wiring.

5. Bring power leads and sensor kit leads through holes in gasket into junction box.

6. Attach ground wire(s) to junction box grounding screw.

7. Position CU4 EZ Plate and metal surface plate with gasket (required for mounting on surface junction boxes) (see pg #7).

8. Strip 1/2" of insulation from all leads. Connect as shown in wiring diagram.

9. Twist on wire nuts. Secure with electrical tape.

10. Make sure all unused openings in CU4 EZ Plate are closed with plugs (provided).

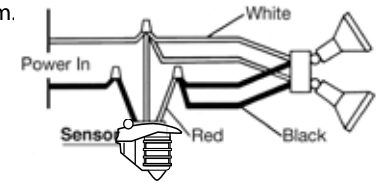

11. Use silicone sealant around plate and all openings to ensure a weather proof seal. Seal all unused conduit entries on surface junction box.

12. Screw in light bulbs. Turn on power.

13. Conduct walk test to adjust sensor response (see page 15).

## Multiple Sensors

Multiple sensors may be wired together, but doing this will make problems difficult to troubleshoot. Single sensors that control their own lights will give a more accurate location of movement and trouble-free operation.

## Multiple Fixtures

Multiple fixtures may be wired to a single sensor.

To handle loads greater than 1000 watts, a qualified electrician should install a relay.

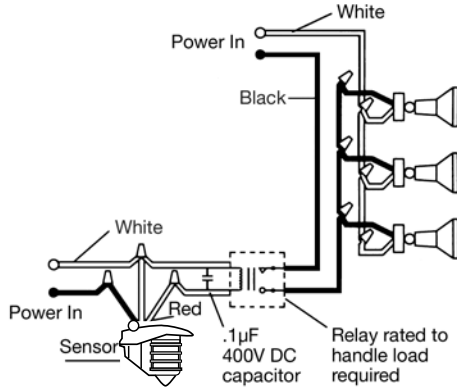

## Power Quality

It is not recommended to install sensors on a circuit that also feeds motor loads such as HVAC equipment, kitchen appliances, or garage door openers. The Stealth circuit is surge and transient protected to IEC specifications. However, if voltage varies significantly from 120 volts, the sensor may malfunction. This may occur on circuits with motor loads.

## Adjusting the Settings

### TIME

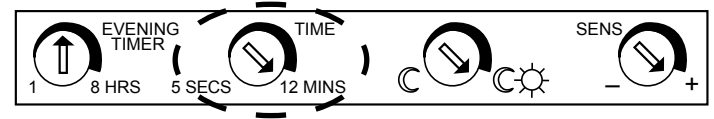

Sets the time that lights will remain on after the detection zone is vacated. Adjustable from approximately 5 seconds to 12 minutes. The factory setting is 12 minutes.

### PHOTOCELL

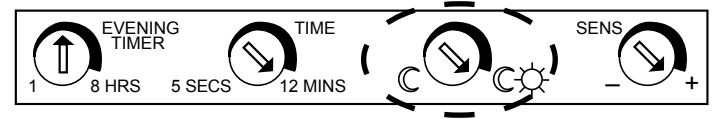

For night-only operation, turn the knob completely counterclockwise to (to the MOON symbol). For 24-hour operation turn the knob all the way clockwise to the MOON/SUN symbol. Adjust counterclockwise to have the sensor come on later at dusk, clockwise to have it come on earlier. The Factory Setting is Night-only (MOON). If you set Evening Timer while set to 24 hour operation Evening Timer will begin immediately after flipping switch.

### SENSITIVITY

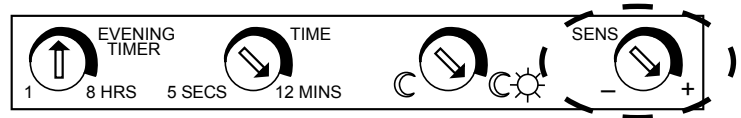

Increases or decreases the responsiveness and range of the sensor (adjustable from 30% to 100%). The Factory Setting is 100%.

## Sensor Modes

### EVENING TIMER



The STL360 provides an alternative to normal motion-activated lighting. The EVENING TIMER can keep lights on continuously - without motion - for 1 to 8 hours after dusk. This is great for evening activities requiring continuous light. During vacations the EVENING TIMER provides a “lived-in” look by simulating an occupant turning lights on at dusk, and then off at bedtime.

To activate the EVENING TIMER, flip the wall switch controlling the sensor three times slowly (off-on-off-on-off-on) within 3 seconds. If you activate the EVENING TIMER during daytime, the middle LED should start blinking, indicating that the EVENING TIMER will start when dusk is detected.

Choose the length of time you want continuous lighting. For example, if you set the EVENING TIMER to “8”, the sensor will keep lights ON continuously for 8 hours after dusk. Once 8 hours have passed, the sensor will revert to motion activated mode. At dawn, the photocell will detect light and prevent lights from turning on during the daytime. The Evening Timer Mode will continue until you de-activate it.

If you do not want to use the EVENING TIMER, do NOT flip the switch 3 times, as described above.

To de-activate the EVENING TIMER, switch the sensor OFF for at least 10seconds, then ON again. Sensor will be in Automatic Mode. (After completing the 30 sec warm-up period)

You can affix this label (right), provided, to your indoor light switch plate for easy reference.

**RAB STEALTH360**

**To Keep Lights On:**  
Switch off-on-off-on within 2 seconds. Resets to Auto Mode at dawn.

**To Set Evening Timer:**  
To keep lights on for 1-8 hours after dusk, set the Evening Timer knob on the sensor, then flip this switch off-on-off-on within 3 seconds.

**To Resume Auto Mode:**  
Switch off for 10 seconds, then back on.

### AUTOMATIC MODE

Lights will turn on when there is movement within the detection zone after dusk.

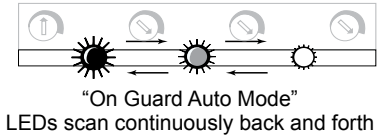

### EVENING TIMER MODE

Keeps lights on for 1-8 hours after dusk. Sensor then reverts to Automatic Mode until dawn. If you set the Evening Timer Mode during daylight, the sensor will be prepared to turn on at dusk and remain on for the number of hours you set. When the sensor is in “Ready for Evening Timer Mode”, the middle LED will blink 3 times, pause and repeat. Set the Evening Timer by flipping the switch that operates the sensor 3 times within 3 seconds (off-onoff-of off-on).



### TEST MODE

The Test Mode will allow you to test the sensor during the day regardless of the photocell setting. To enter Test Mode, turn time setting to 5 sec on the unit. Turn power off for 10 secs then back on. There is a 30 second warm-up period, then the Test Mode starts. During the warm-up, the lights stay on continuously and LEDs are off. During Test Mode the LEDs remain off. The sensor will stay in Test Mode until the detection zone is vacated for one minute.

During the Test Period, the sensor will keep lights on for 5 seconds each time it detects movement in its detection zone. Perform the walk test and make any adjustments needed. Vacate the detection zone for one minute or more to end Test Mode. Scanning LEDs will appear when test mode ends. Set back to desired time setting after testing complete.





## Walk Testing

### MANUAL OVERRIDE MODE

The STL360 has a “protected” Manual Override that requires a double-flip of the light switch so momentary power problems do not interfere with normal sensor operation.

By flipping the switch that operates the sensor twice (off-on-off-on) within 2 seconds you will override the sensor to keep lights on continuously until dawn.

If you set the Manual Override Mode during daylight, the sensor will be prepared to turn on at dusk and remain on until dawn. This is a handy feature if you leave home for the day and you want the lights on to greet you when you return. When the sensor is in “Ready for Manual Override Mode” the middle LED will be on.



“Ready for Manual Override Mode”  
Middle LED on

### TO RESUME AUTOMATIC MODE

Switch OFF the power for at least 10 seconds, then turn it ON again. Sensor will reset to Automatic Mode after completing the warm-up period.

### DAYTIME (24-HOUR) OPERATION OF MANUAL OVERRIDE

If you set Manual Override while set to 24 hour operation, lights will come on and remain on continuously.

**Lights will not turn off at dawn.**

STL360’s full coverage pattern reduces the need for aiming and adjustment. The purpose of the Walk Test is to check and adjust the coverage pattern. The STL360 must be manually set into Test Mode (see pg 13).

To enter Test Mode:

Turn Time setting to 5 seconds and turn off sensor for 10 seconds. After a warm up period of 30 seconds the LEDs will be off.

1. Aim the sensor at the traffic pattern you want to detect. Sensor will detect any movement ACROSS its pattern most effectively.
2. Start outside the pattern and walk across the pattern until the lights go on. As distance from the sensor increases, it will take more movement to be detected.
3. Adjust sensor aiming as necessary to improve coverage. Make sure sensor is level.
4. Sensitivity may be decreased with the SENS knob to detect a limited area or if the sensor is being activated by wind, foliage, traffic or animals, or increased to cover a larger area. [See pg. 11-12 to adjust sensor settings.] The lens mask can also be used to drastically reduce coverage, or allow undetected movement from some directions.
5. STL360 is factory set for night only operation. For 24 hour operation, turn the photocell control completely toward the SUN/MOON setting. Turn counter clockwise to have the sensor come on later at dusk, clockwise to have it come on earlier.
6. Repeat steps 1-5 until you are satisfied with coverage. Vacate the detection zone for 1 minute and then turn the settings back to desired time delay. Your sensor is now ready for operation.

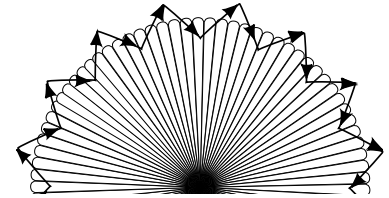

## Technical Tips: Lights Do Not Turn Off

1. Make sure that the sensor is not in Manual Override Mode. Turn sensor OFF for 10 seconds, then back ON. The Sensor will be go through 30 second warm up period where the lights are one then will go into Automatic Mode with lights off and ready to detect movement.
2. Make sure that the sensor is not in Evening Timer Mode. Turn power OFF for 10 seconds (see # 1).
3. Make sure sensor is not aimed at or mounted over something that would move or change temperature such as waving branches, water, air conditioners, windows or heating vents even on neighboring property. You can test for infrared sources in the area by placing a box or bag over the sensor. Put sensor into test mode. Lights should stay off. Wave your hand inside bag in front of sensor. Lights should go on and then time out. If sensor operates properly when covered, check items # 4-8.

**Problem:** Sensor is triggered by unwanted movement or heat source.

**Solution:**

- (1) Aim sensor away from movement, or
- (2) Mask lens in the direction of the source
- (3) Lower sensitivity control setting

4. Make sure sensor and lights are mounted firmly and do not move even slightly when touched. If they move, tighten all screws.
5. Make sure sensor is not mounted on an unstable object such as a tree or pole that will move in the wind.

**Problem:** Movement of tree triggers sensor.

**Solution:** Mount on stable surface.

6. Was sensor wired hot (with power on etc)? If so, circuitry may have been damaged.
7. Make sure sensor is not aimed within 20 feet of a road.

**Problem:** Passing cars activate sensor.

**Solution:** A 20 foot safety zone and lower sensitivity are recommended to avoid activation from passing cars.

8. Make sure heat from lights is not triggering sensor. Make sure the sensor is below and as far as possible away from lights.

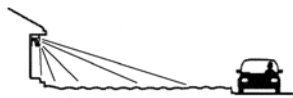
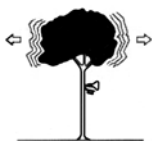
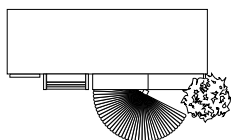
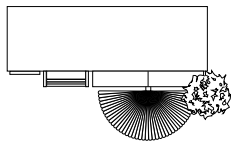

## Technical Tips: Lights Turn On and Off Inappropriately

1. Make sure the sensor is installed on its own dedicated circuit, free of motor loads such as HVAC equipment, kitchen appliances or garage door openers.
2. It is not recommended to wire sensors in parallel. More than one sensor wired together makes them difficult to troubleshoot. Disconnect multiple sensors and test separately.
3. Keep all people completely out of the detection pattern to make sure the sensor is not detecting them.

4. Make sure sensor is located below and as far as possible from its lights. Heat from the lights may trigger the sensor.

Solution: Move sensor below and away from the lights.

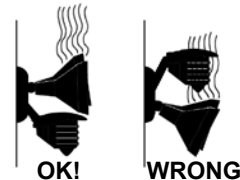

5. Make sure lights are not reflecting back into sensor. Check for white or reflective surfaces close to the sensor.

Solution: Aim sensor away from reflective objects, or move the objects and lower sensitivity.

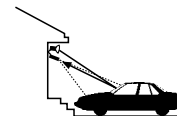

6. Make sure sensor is not aimed within 20 feet of a road or sidewalk. Passing cars will activate sensor.

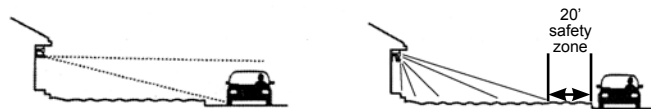

Solution: A 20 foot safety zone and reduced sensitivity are recommended to avoid activation from passing cars.

7. Heavy rain, snow or high winds may activate the sensor occasionally. Reduce sensitivity control slightly until problem stops.
8. Moths can be attracted to the lights and fly close to the sensor causing triggering. Reducing the sensitivity may help.
9. Check Solutions #3, 4, 5, 6, 7 and 8 under "Lights Do Not Turn OFF".

## Technical Tips: Lights Do Not Turn On

1. Check that lamps and fixtures work. Compare wiring to the wiring diagram in this manual. Check that the power is on.
2. If installing during daylight, LED will go into automatic mode after 30 sec warm up period and will not work during daylight if the photocell is turned to the night only position (moon symbol).

If you require a test mode, turn time setting to 5 seconds and turn the power off at least 10 seconds and back on again.

If you require the sensor to operate both day and night, turn the SUN/MOON control knob clockwise to the sun and moon symbol.

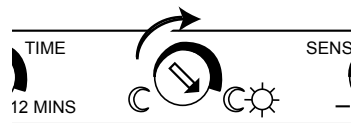

3. Check that lights from another source, such as adjacent porch lights, garden lights or street lights are not in the sensor's view. The sensor's photocell may detect the light and deactivate "daylight".

If you desire the sensor to operate in higher ambient light levels, turn the SUN/MOON control knob counter clockwise toward the sun symbol.

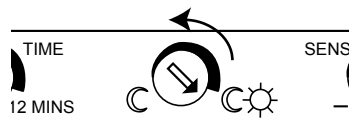

4. Was sensor wired hot? If so circuitry may have been damaged.

## Technical Tips: Lights Turn Off too quickly

1. Check if sensor is being "tricked" by reflected light. If lights controlled by the sensor shine or reflect into the photocell (located behind the lens) the unit will go on briefly, see its own light, and turn off "thinking" that it is daytime:

Problems:  
Lights reflect into photocell  
Lights shine directly into photocell



Solution:  
Adjust SUN/MOON knob slightly clockwise, to allow operation at higher ambient light levels. Alternatively, move the lights or reflectors or mask the lens in the direction of the lights and/or reflections.

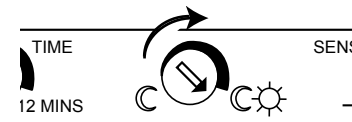

2. Check if "R" lamps, non-reflector "A" lamps or self-ballasted PL lamps are being used in non-enclosed lampholder. If so, switch to reflector PAR floodlight lamps so the sensor is not affected by stray light. If using PAR floodlight lamps, consider using lower wattage, energy saving lamps.

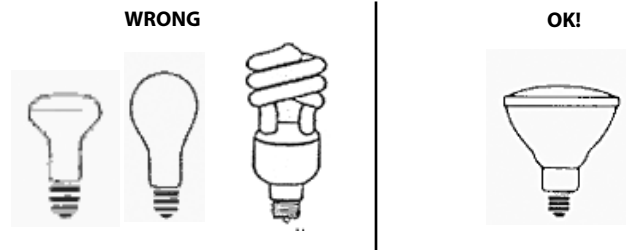

## Technical Tips: Range Appears Limited

1. Check that the sensor is level from side to side and pointed at the area you desire. If unit is tilted, part of the detection zone may be high in the air over people's heads.

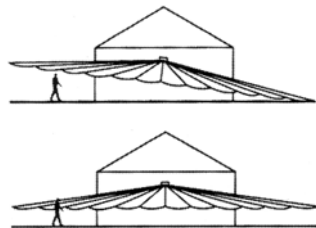

**Solution:** Position sensor exactly level from side to side.

2. Check that the sensor is not mounted too high. If mounted above 20', much of the usable range will be lost.

**Solution:** Mounting at 6' to 10' allows maximum range.

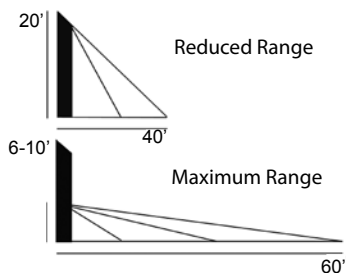

3. Check that movement is not directly towards sensor. Sensor will see movement across its pattern more quickly. To fix, move the sensor.

4. Check that movement far away and directly towards sensor is not entirely within one zone.

**Problem:** Sensor will not detect until movement crosses zones.

**Solution:** "Micro Adjust" sensor by moving sideways 1/4". This may move the zones to allow earlier detection.

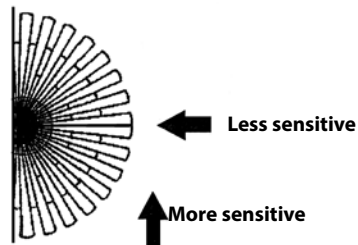

No detection until here

Detection here now

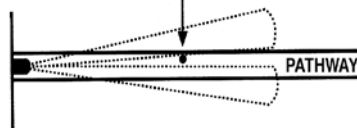

## Contents of Accessory Kit

- 2 Lens Masks
- Indoor Switchplate Label
- 3 Wire Nuts
- Adjustment Tool
- Mylar lens Mask



- Crossbar with Green Ground Screw
- Hanging Hook
- 1/2" Close Up Plugs (3)
- Slotted Screws (4)
- Finishing Cap
- O-ring Gasket
- Center Mounting Screw

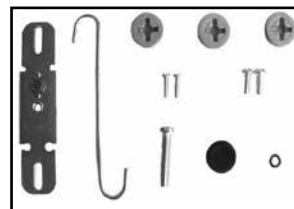

- Metal Surface Mounting Plate with Gasket

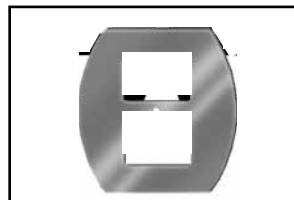

## Limited Warranty

The RAB Sensor will be free from defects in materials and workmanship for a period of ten (10) years from the date of delivery to the end-user.

**Sensors must be installed by a properly insured and licensed electrician or under the supervision of a licensed electrician and the product must be in its original, unopened and new condition at the time of installation. The information provided in the RAB Sensor Owner's Manual is critical in determining the location, conditions, intended use and other requirements with respect to the use and installation of a sensor product. Using a sensor product in any manner other than as disclosed in the RAB Owner's Manual automatically voids the warranty.**

**Exceptions.** The above warranties shall not apply and RAB makes no representations or warranties with respect to:

- a. problems caused by acts of God including without limitation lightning strikes; and
- b. problems caused by any improper action or failure to act by any person or entity other RAB, including without limitation problems caused by improper installation by the buyer, an authorized RAB distributor, or any other person or entity; and
- c. using or installing a sensor product in any manner other than as disclosed in the RAB Owner's Manual.

- d. use with Instant Start ballasts; use with Instant Start ballasts will void the RAB warranty.

**Out of warranty sensors replacement program.** If your sensor is out of warranty or if damage is unrelated to its original manufacture, return your sensor (freight prepaid and insured) directly to us (at RAB Lighting Inc. 170 Ludlow Ave. Northvale, NJ 07647) with a check for \$20.00 made payable to RAB Lighting Inc. We will repair or replace your sensor promptly.

# RAB Lighting Product Warranties

The following warranties apply to RAB Lighting, Inc. ("RAB") products that meet all of the following conditions: (a) the product was purchased by the contractor or end-user from an authorized RAB distributor who purchased the product directly from RAB and from no other source; (b) if the product has been installed, the entire installation was performed by a licensed electrician or under the supervision of a licensed electrician and the product was in its original, unopened and new condition at the time of installation. RAB LIGHTING DISCLAIMS ALL REPRESENTATIONS AND WARRANTIES WITH RESPECT TO ALL OTHER PRODUCTS, INCLUDING WITHOUT LIMITATION PRODUCTS THAT HAVE BEEN PURCHASED FROM ANY PERSON OR ENTITY OTHER THAN AN AUTHORIZED RAB DISTRIBUTOR, OR INSTALLED BY ANY PERSON OR ENTITY OTHER THAN A LICENSED ELECTRICIAN OR UNDER THE SUPERVISION OF A LICENSED ELECTRICIAN, AND ALL PRODUCTS THAT ARE USED OR ARE OTHERWISE NOT IN THEIR ORIGINAL RAB LIGHTING PACKAGING AT THE TIME OF INSTALLATION.

**Remedy.** RAB's obligations for breach of warranty shall be limited to repair or replacement, at RAB's option, of any products or parts which prove to be defective, provided that buyer gives RAB written notice and returns the defective product to RAB in accordance with RAB's return material authorization (RMA) policies, and RAB confirms the defect. Buyer is responsible for all costs to de-install defective products and re-install replacement or repaired products and RAB shall not be liable for labor or other costs related to de-installation or re-installation.

**DISCLAIMER.** THE FOREGOING WARRANTIES ARE IN LIEU OF, AND RAB EXPRESSLY DISCLAIMS, ALL OTHER REPRESENTATIONS, GUARANTEES AND WARRANTIES, EXPRESS OR IMPLIED IN FACT OR BY LAW, INCLUDING WITHOUT LIMITATION ALL WARRANTIES OF MERCHANTABILITY OR FITNESS FOR A PARTICULAR PURPOSE OR OTHERWISE. THE FOREGOING WARRANTIES STATE RAB'S ENTIRE AND EXCLUSIVE LIABILITY, AND BUYER'S SOLE AND EXCLUSIVE REMEDY, IN CONNECTION WITH THE PRODUCTS AND ALL PARTS, THEIR DESIGN, SUITABILITY FOR USE, INSTALLATION AND OPERATION.

**LIMITATION OF LIABILITY.** RAB shall not be liable under any theory of relief, including without limitation breach of warranty, breach of contract, tort (including negligence), strict liability, or otherwise, arising out of or related to any breach of warranty, any RAB products and the use thereof, or any other acts or omissions of RAB for: (i) any indirect, incidental, special or consequential damages, whatsoever (including without limitation, loss of anticipated value of a business or its reputation) or (ii) any damage or loss in excess of the price actually paid by buyer to the authorized RAB distributor for the products that caused the damages. Any action by buyer must be commenced within one year after the cause of action has accrued.

**Miscellaneous.** These product warranty terms shall be governed by the laws of the State of New York. Buyer consents to the personal jurisdiction and venue of the courts of the State of New York. Any legal or equitable claim of any nature arising hereunder shall be filed and maintained in the state or federal courts in the State of New

York and buyer agrees that such courts are a convenient forum for adjudication. In the event that suit is necessary to recover amounts owed RAB, buyer shall be liable for reasonable attorney's fees, interest and costs of collection. No agreement or understanding varying the terms and conditions hereof shall be binding upon RAB or buyer unless in writing and signed by duly authorized representatives of both parties. These product warranty terms shall inure to the benefit of and be binding upon the parties hereto and their respective successors and assigns.

## Toll Free Technical Assistance

If you need technical assistance, please do the following:

1. Re-read the Technical Tips sections of this manual.
2. Call the Tech Help Line at 888 RAB-1000, 8AM to 6PM Eastern Time M-F and we will be glad to help you. Before you call, please have the following information handy:
  - a) Catalog number of your unit;
  - b) Wattage, types and locations of lights connected to the sensor;
  - c) The electrical circuit on which the sensor is installed. What else does it feed? How is the sensor power switched?
  - d) Serial Number (4 digits) on the back of the sensor.
  - e) This installation Manual

RAB Lighting cannot give electrical wiring instructions by phone. Please consult a qualified electrician

*Note: These instructions do not cover all details or variations in equipment nor do they provide for every possible situation during installation operation or maintenance.*