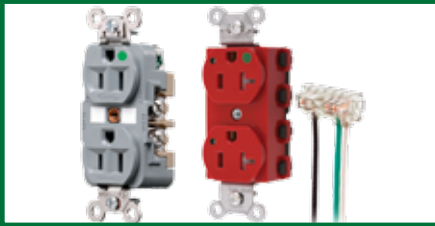



Table of Contents



HBL® Extra Heavy Duty Industrial Series



Industrial and Commercial Series GFCIs



Surge Protection Devices

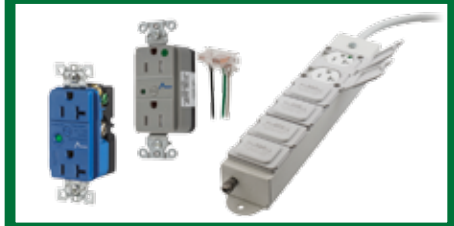

Product	Page
HBL® Extra Heavy Duty Hospital Grade Duplex Receptacles	
Products at a Glance	L-2
Features and Benefits	L-3
Duplex and Style Line® Decorator	L-4
SNAPConnect® Receptacles	L-5
Hubbell-PRO Receptacles	L-8
USB Charger Receptacles	L-10
Single and 4-PLEX® Receptacles	L-10
Hospital Grade Plugs, Connector Bodies and Receptacles	
15 and 20A, 125V	L-11
15 and 20A, 250V	L-11

Product	Page
Extra Heavy Duty Industrial GFCI Receptacles	L-12
Commercial GFCI Receptacles	
Tamper-Resistant	L-13
Tamper-Resistant and Weather Resistant	L-14
Standard	L-15
Hospital Grade Surge Protection Devices	L-16
Hubbellock® Plugs, Connectors and Receptacles	L-17
Hubbellock® Mobile X-Ray Devices	L-18



Products at a Glance



HBL® Extra Heavy Duty Hospital Grade

- Hospital Grade with green dot symbol
- One-piece nickel-plated integral ground strap
- ID marking surface for quick circuit identification
- Square head, 10-thread bronze center rivet
- Deep nylon body design increases impact and chemical resistance



Extra Heavy Duty SNAPConnect®

- Hospital and Specification Grade
- Tamper-Resistant, NOT Plug Resistant™
- Power indicating LED
- Steel mounting strap, self-grounding
- Compact size requires minimal space



Hubbell-PRO Heavy Duty

- Hospital and Specification Grade
- Tamper-Resistant, NOT Plug Resistant™
- Power LED feature
- Circuit ID marking area
- Steel mounting strap, self-grounding
- Assembled in USA



USB Charger Receptacles

- Two Type-C, Type A&C and Type A port configurations, high power 5 Amp, 5 Volt USB output
- Heavy duty stainless steel USB ports; rated for 10,000 cord insertions and removals
- Patented Hubbell Tamper-Resistant technology uses cam action shutters. The friction-free design of the mechanism's doors requires much less force
- Available in SNAPConnect®



4-PLEX Receptacles

- Hospital Grade and Surge
- Mounts directly to 4-inch square box
- "A" and "B" circuit ID molded into face
- Removable knockouts for mounting to octagon concrete ring or box
- Heavy duty, triple wipe, brass power and ground contacts



SpikeShield® Surge Suppression Plug Strips

- UL2930 HCOA's
- UL1449 SPD's available
- 15A and 20A versions
- 6 foot or 15 foot cords available
- USB versions in several models



Hubbellock® Devices

- Nylon cover, thermoset interior
- Armored, epoxy filled, rubber cord grip
- Black, back wired
- Mobile X-Ray devices



Features and Benefits

Hubbell “Hospital Grade” Devices

UL requirements for Hospital Grade devices is more stringent than those for standard devices. Hubbell receptacles are designed to meet and exceed the standards.

- Exclusive nickel-plated bypass contact design increases contact pressure, lowering the operating temperature.
- Four point grounding system provides redundant grounding for low resistance ground continuity in high abuse areas.
- High tech reinforced thermoplastic polyester (RTP) back is tough and heat resistant.

Because of these features and others, the benefit is performance, reliability, and value for any health care facility.



HBL8200GY



Housing Design

- Reinforced thermoplastic base provides superior thermal, electrical and mechanical properties
- Providing contact stability, this high performance material will reduce heat buildup giving you long lasting performance
- Deep body design increases impact and chemical resistance



Terminals

- External wiring clamps allow for visual inspection of the terminals
- Unique strand containment feature on the terminal “bundles” the wire, ensuring 100% clamping of wire strands and reducing heat from the termination

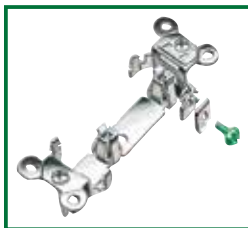

One-Piece Mounting Strap

- Back wired ground terminal allows faster, easier installation
- One-piece nickel-plated brass integral ground strap for greater corrosion resistance
- Patented ground contact provides redundant grounding

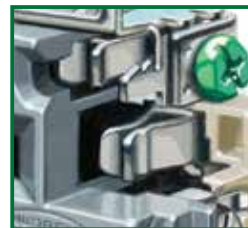

Contacts

- Exclusive bypass contacts are made of nickel-plated brass alloy, increasing blade retention, insuring reliable uninterrupted flow of power
- Barbed assembly arms reduce possibility of face/base separation



Identification

- I.D. marking surface provides quick, sure circuit identification
- All Hospital Grade devices are marked with the green dot symbol, required by UL



Center Rivet

- Square head, 10-thread bronze center rivet won't rotate, reduces stripping and resists corrosion

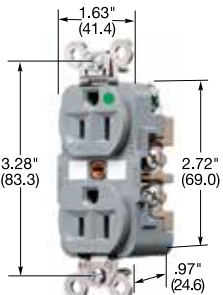

HBL8200GY

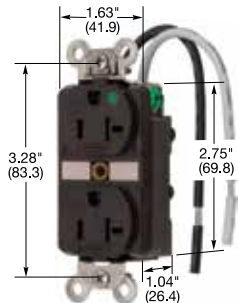

HBL8300SGA

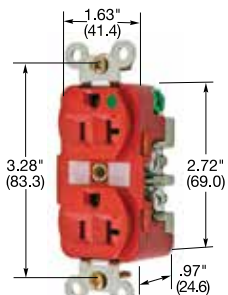

HBL8300RMRI

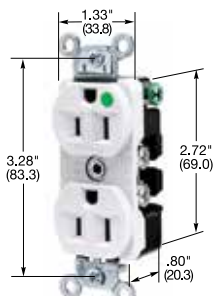

HBL8200ILW

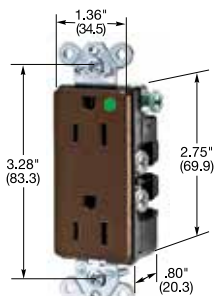

HBL2172

Dimensions in Inches (mm)

IP20
SUITABILITY



15A 125V
NEMA 5-15R
UL CSA
0.5 HP



20A 125V
NEMA 5-20R
UL CSA
1 HP

HBL® Extra Heavy Duty Hospital Grade Receptacles

Duplex

Description	Color	Catalog Number	
Flush, thermoplastic polyester face, back and side wired.	Black	HBL8200BK	-
	Blue	-	HBL8300BL
	Brown	HBL8200	HBL8300
	Gray	HBL8200GY	HBL8300GY
	Ivory	HBL8200I	HBL8300I
	Light Almond	HBL8200LA	HBL8300LA
	Red	HBL8200RED	HBL8300RED
	White	HBL8200W	HBL8300W
Flush, LED illuminated face, back and side wired.	Gray	HBL8200ILGY	HBL8300ILGY
	Ivory	HBL8200ILI	HBL8300ILI
	Red	HBL8200ILR	HBL8300ILR
	White	HBL8200ILW	HBL8300ILW
Tamper-Resistant receptacle with wire leads. Complies with requirements of NEC® article 517-18(c).	Brown	HBL8200SGA	HBL8300SGA
	Gray	HBL8200SGGYA	HBL8300SGGYA
	Ivory	HBL8200SGIA	HBL8300SGIA
	Light Almond	HBL8200SGLA	HBL8300SGLA
	Red	HBL8200SGRA	HBL8300SGRA
	White	HBL8200SGWA	HBL8300SGWA
Isolated ground ^A .	Orange	IG8200	IG8300
	Red	IG8200R	IG8300R

MRI Receptacle, Duplex

Description	Color	Catalog Number	
MRI receptacle, flush, thermoplastic polyester face, back and side wired.	Ivory	HBL8200IMRI	HBL8300IMRI
	Light Almond	HBL8200LAMRI	HBL8300LAMRI
	Red	HBL8200RMRI	HBL8300RMRI
	White	HBL8200WMRI	HBL8300WMRI

Slender/Compact, Duplex

Description	Color	Catalog Number	
Flush, thermoplastic polyester face, back, and side wired. Fed. Spec. verified.	Brown	HBL8200H	HBL8300H
	Gray	HBL8200HG	HBL8300HG
	Green	-	HBL8300HGN
	Ivory	HBL8200HI	HBL8300HI
	Light Almond	HBL8200HLA	HBL8300HLA
	Red	HBL8200HRED	HBL8300HRED
	White	HBL8200HW	HBL8300HW

Style Line® Decorator*

Description	Color	Catalog Number	
Flush, nylon face, back and side wired.	Brown	HBL2172	HBL2182
	Gray	HBL2172GY	HBL2182GY
	Ivory	HBL2172I	HBL2182I
	Office White	-	HBL2182OW
	Red	HBL2172R	HBL2182R
	White	HBL2172WA	HBL2182WA
Isolated ground ^A .	Ivory	-	IG2182I
	Orange	-	IG2182
	White	-	IG2182WA

Note: ^ASee section M for additional information on isolated ground devices.

*Not Fed. Spec. Listed.

See pages A-48 and A-49 for accessories.

See page Tech-10 for Tamper-Resistant description.

See section N for wallplates.

NEC® is a registered trademark of the National Fire Protection Association (NFPA).

IP20
SUITABILITY



15A 125V
NEMA 5-15R
UL CSA
0.5 HP



20A 125V
NEMA 5-20R
UL CSA
1 HP

Extra Heavy Duty Hospital Grade ● SNAPConnect®

Duplex

Description	Color	Catalog Number	Catalog Number
Hospital grade, finder groove, nylon face, modular receptacle which requires pigtailed connector below.	Black	SNAP8200BKA	SNAP8300BKA
	Brown	SNAP8200A	SNAP8300A
	Gray	SNAP8200GYA	SNAP8300GYA
	Ivory	SNAP8200IA	SNAP8300IA
	Light Almond	SNAP8200LAA	SNAP8300LAA
	Red	SNAP8200RA	SNAP8300RA
White	SNAP8200WA	SNAP8300WA	
Hospital grade, smooth nylon face, modular receptacle which requires pigtailed connector below. Assembled in USA.	Black	SNAP8200BKNA	SNAP8300BKNA
	Brown	SNAP8200NA	SNAP8300NA
	Gray	SNAP8200GYNA	SNAP8300GYNA
	Ivory	SNAP8200INA	SNAP8300INA
	Light Almond	SNAP8200LANA	SNAP8300LANA
	Red	SNAP8200RNA	SNAP8300RNA
White	SNAP8200WNA	SNAP8300WNA	
Hospital grade, Tamper-Resistant, smooth nylon face, modular receptacle which requires pigtailed connector below. Assembled in USA.	Black	SNAP8200BKTRA	SNAP8300BKTRA
	Brown	SNAP8200TRA	SNAP8300TRA
	Gray	SNAP8200GYTRA	SNAP8300GYTRA
	Ivory	SNAP8200ITRA	SNAP8300ITRA
	Light Almond	SNAP8200LATRA	SNAP8300LATRA
	Red	SNAP8200RTRA	SNAP8300RTRA
White	SNAP8200WTRA	SNAP8300WTRA	
Hospital grade, Tamper-Resistant, Split Circuit, smooth nylon face, modular receptacle which requires pigtailed connector below. Assembled in USA.	Black	SNAP8200BKSCTRA	SNAP8300BKSCTRA
	Brown	SNAP8200SCTRA	SNAP8300SCTRA
	Gray	SNAP8200GYSCTRA	SNAP8300GYSCTRA
	Ivory	SNAP8200ISCTRA	SNAP8300ISCTRA
	Light Almond	SNAP8200LASCTRA	SNAP8300LASCTRA
	Red	SNAP8200RSCTRA	SNAP8300RSCTRA
White	SNAP8200WSCTRA	SNAP8300WSCTRA	
Isolated ground ^A , Hospital grade, Tamper-Resistant.	Orange	SNAP8200IGTRA	SNAP8300IGTRA
Red	SNAP8200RIGTRA	SNAP8300RIGTRA	
Hospital grade, with Power Indicating LED, smooth nylon face, modular receptacle which requires pigtailed connector below. Assembled in USA.	Black	SNAP8200BKL	SNAP8300BKL
	Brown	SNAP8200L	SNAP8300L
	Gray	SNAP8200GYL	SNAP8300GYL
	Ivory	SNAP8200IL	SNAP8300IL
	Light Almond	SNAP8200LAL	SNAP8300LAL
	Red	SNAP8200RL	SNAP8300RL
White	SNAP8200WL	SNAP8300WL	
Isolated ground ^A , Hospital grade, with Power Indicating LED.	Orange	SNAP8200IGL	SNAP8300IGL
Red	SNAP8200RIGL	SNAP8300RIGL	
Hospital grade, Tamper-Resistant, with Power Indicating LED, smooth nylon face, modular receptacle which requires pigtailed connector below. Assembled in USA.	Black	SNAP8200BKLTRA	SNAP8300BKLTRA
	Brown	SNAP8200LTRA	SNAP8300LTRA
	Gray	SNAP8200GYLTRA	SNAP8300GYLTRA
	Ivory	SNAP8200ILTRA	SNAP8300ILTRA
	Light Almond	SNAP8200LALTRA	SNAP8300LALTRA
	Red	SNAP8200RLTRA	SNAP8300RLTRA
White	SNAP8200WLTRA	SNAP8300WLTRA	
Isolated ground ^A , Hospital grade, TR with Power Indicating LED.	Orange	SNAP8200IGLTRA	SNAP8300IGLTRA
	Red	SNAP8200RIGLTRA	SNAP8300RIGLTRA

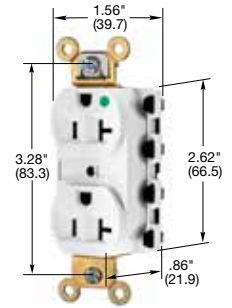

SNAP8300WA

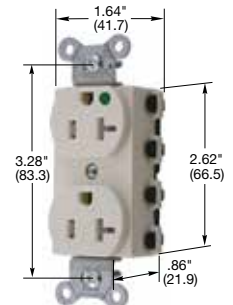

SNAP8300LATR

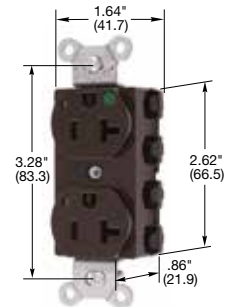

SNAP8300L

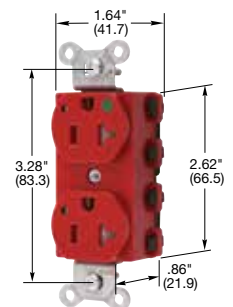

SNAP8300RLTR

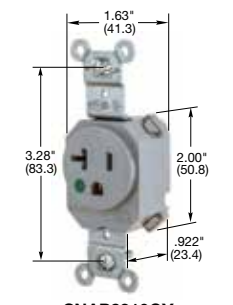

SNAP8310GY

Dimensions in Inches (mm)

SNAPConnect® Extra Heavy Duty Hospital Grade Single Receptacles

Color	Hospital Grade ●		Hospital Grade ● Tamper-Resistant	
	15A 125V	20A 125V	15A 125V	20A 125V
Almond	SNAP8210AL	SNAP8310AL	SNAP8210ALTR	SNAP8310ALTR
Black	SNAP8210BK	SNAP8310BK	SNAP8210BKTR	SNAP8310BKTR
Blue	SNAP8210BL	SNAP8310BL	SNAP8210BLTR	SNAP8310BLTR
Brown	SNAP8210	SNAP8310	SNAP8210TR	SNAP8310TR
Gray	SNAP8210GY	SNAP8310GY	SNAP8210GYTR	SNAP8310GYTR
Ivory	SNAP8210I	SNAP8310I	SNAP8210ITR	SNAP8310ITR
Light Almond	SNAP8210LA	SNAP8310LA	SNAP8210LATR	SNAP8310LATR
Red	SNAP8210R	SNAP8310R	SNAP8210RTR	SNAP8310RTR
White	SNAP8210W	SNAP8310W	SNAP8210WTR	SNAP8310WTR

IP20
SUITABILITY



15A 125V
NEMA 5-15R
UL CSA
0.5 HP



20A 125V
NEMA 5-20R
UL CSA
1 HP

Extra Heavy Duty Hospital Grade ● SNAPConnect®

Style Line® Decorator

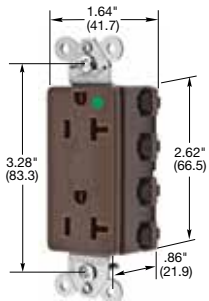

SNAP2182A

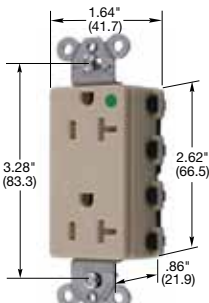

SNAP21821TR

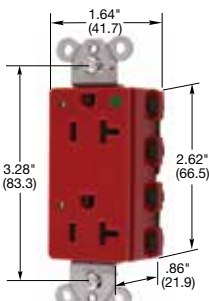

SNAP2182RL

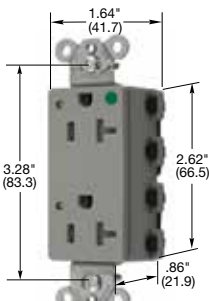

SNAP2182GYLTR

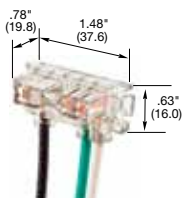

SNAP1RA

Description	Color	Catalog Number	
Hospital grade, Style Line® decorator, flush, nylon face, modular receptacle which requires pigtailed connector below.	Black	SNAP2172BKA	SNAP2182BKA
	Brown	SNAP2172A	SNAP2182A
	Gray	SNAP2172GYA	SNAP2182GYA
	Ivory	SNAP2172IA	SNAP2182IA
	Light Almond	SNAP2172LAA	SNAP2182LAA
	Red	SNAP2172RA	SNAP2182RA
	White	SNAP2172WA	SNAP2182WA
Hospital grade, Style Line® decorator, flush, nylon face, modular receptacle which requires pigtailed connector below. Assembled in USA.	Black	SNAP2172BKNA	SNAP2182BKNA
	Brown	SNAP2172NA	SNAP2182NA
	Gray	SNAP2172GYNA	SNAP2182GYNA
	Ivory	SNAP2172INA	SNAP2182INA
	Light Almond	SNAP2172LANA	SNAP2182LANA
	Red	SNAP2172RNA	SNAP2182RNA
	White	SNAP2172WNA	SNAP2182WNA
Hospital grade, Tamper-Resistant, Style Line® decorator, flush, nylon face, modular receptacle which requires pigtailed connector below. Assembled in USA.	Black	SNAP2172BKTRA	SNAP2182BKTRA
	Brown	SNAP2172TRA	SNAP2182TRA
	Gray	SNAP2172GYTRA	SNAP2182GYTRA
	Ivory	SNAP2172ITRA	SNAP2182ITRA
	Light Almond	SNAP2172LATRA	SNAP2182LATRA
	Red	SNAP2172RTRA	SNAP2182RTRA
	White	SNAP2172WTRA	SNAP2182WTRA
Hospital grade, Tamper-Resistant, Split Circuit, Style Line® decorator, flush, nylon face, modular receptacle which requires pigtailed connector below. Assembled in USA.	Black	SNAP2172BKSCTRA	SNAP2182BKSCTRA
	Brown	SNAP2172SCTRA	SNAP2182SCTRA
	Gray	SNAP2172GYSCTRA	SNAP2182GYSCTRA
	Ivory	SNAP2172ISCTRA	SNAP2182ISCTRA
	Light Almond	SNAP2172LASCTRA	SNAP2182LASCTRA
	Red	SNAP2172RSCTRA	SNAP2182RSCTRA
	White	SNAP2172WSCTRA	SNAP2182WSCTRA
Isolated ground ^A , Hospital grade, Tamper-Resistant.	Orange	SNAP2172IGTRA	SNAP2182IGTRA
	Red	SNAP2172RIGTRA	SNAP2182RIGTRA
Hospital grade, with Power Indicating LED, Style Line® decorator, flush, nylon face, modular receptacle which requires pigtailed connector below. Assembled in USA.	Black	SNAP2172BKL	SNAP2182BKL
	Brown	SNAP2172L	SNAP2182L
	Gray	SNAP2172GYL	SNAP2182GYL
	Ivory	SNAP2172IL	SNAP2182IL
	Light Almond	SNAP2172LAL	SNAP2182LAL
	Red	SNAP2172RL	SNAP2182RL
	White	SNAP2172WL	SNAP2182WL
Isolated ground ^A , Hospital grade, with Power Indicating LED.	Orange	SNAP2172IGL	SNAP2182IGL
	Red	SNAP2172RIGL	SNAP2182RIGL
Hospital grade, Tamper-Resistant, with Power Indicating LED, Style Line® decorator, flush, nylon face, modular receptacle which requires pigtailed connector below. Assembled in USA.	Black	SNAP2172BKLTR	SNAP2182BKLTR
	Brown	SNAP2172LTR	SNAP2182LTR
	Gray	SNAP2172GYLTR	SNAP2182GYLTR
	Ivory	SNAP2172ILTR	SNAP2182ILTR
	Light Almond	SNAP2172LALTR	SNAP2182LALTR
	Red	SNAP2172RLTR	SNAP2182RLTR
	White	SNAP2172WLTR	SNAP2182WLTR
Isolated ground ^A , Hospital grade, TR with Power Indicating LED.	Orange	SNAP2172IGLTR	SNAP2182IGLTR
	Red	SNAP2172RIGLTR	SNAP2182RIGLTR

Note: ^ASee section M additional information on isolated ground devices.

See page A-16 for additional information on SNAPConnect® features.

See page Tech-10 for Tamper-Resistant and LED Power Indicators description.

See pages A-50 and A-51 for accessories.

See section N for wallplates.

SNAPConnect® Right Angle Pigtailed Connector

Description	Wire Type	General Use	Assembled in USA
Clear right angle terminal with 6 inch leads #12 AWG THHN/THWN-2; Polycarbonate housing material	Solid	SNAP1RA	SNAP1RNA
	Stranded	SNAP2RA	SNAP2RNA

Note: For Assembled in USA products, must order connector with NA suffix.

Dimensions in Inches (mm)



SNAPConnect® GFCI LED Hospital Grade ●, Assembled in USA

Description	Rating	Color	Catalog Number	
Hospital Grade SNAPConnect GFCI LED, self-grounding staple, requires connector below, sold separately.	15 and 20A 125V AC	Almond	GFRST82SNAPAL	GFRST83SNAPAL
		Black	GFRST82SNAPBK	GFRST83SNAPBK
		Brown	GFRST82SNAP	GFRST83SNAP
		Gray	GFRST82SNAPGY	GFRST83SNAPGY
		Ivory	GFRST82SNAPI	GFRST83SNAPI
		Light Almond	GFRST82SNAPLA	GFRST83SNAPLA
		Red	GFRST82SNAPR	GFRST83SNAPR
		White	GFRST82SNAPW	GFRST83SNAPW



15A 125V
NEMA 5-15R
UL CSA
0.5 HP



20A 125V
NEMA 5-20R
UL CSA
1 HP



Meets UL
Standard 943
Class A GFCI

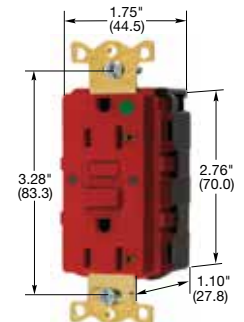

GFRST83SNAPR

SNAPConnect® GFCI LED Hospital Grade ●, Tamper and Weather Resistant, Assembled in USA

Description	Rating	Color	Catalog Number	
Hospital Grade SNAPConnect GFCI TR/WR, self-grounding staple, requires connector below, sold separately.	15 and 20A 125V AC	Almond	GFTWRST82SNAPAL	GFTWRST83SNAPAL
		Black	GFTWRST82SNAPBK	GFTWRST83SNAPBK
		Brown	GFTWRST82SNAP	GFTWRST83SNAP
		Gray	GFTWRST82SNAPGY	GFTWRST83SNAPGY
		Ivory	GFTWRST82SNAPI	GFTWRST83SNAPI
		Light Almond	GFTWRST82SNAPLA	GFTWRST83SNAPLA
		Red	GFTWRST82SNAPR	GFTWRST83SNAPR
		White	GFTWRST82SNAPW	GFTWRST83SNAPW

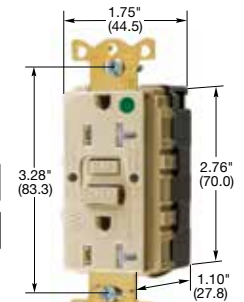

GFTWRST83SNAPI

SNAPConnect® USB Charger Hospital Grade ●, Duplex Receptacles

Description	Color	Catalog Number	
Hospital Grade SNAPConnect USB Charger, Tamper-Resistant Style Line® decorator duplex receptacle, two USB type 2.0 ports 3 Amp, 5 Volt DC, 15 or 20 Amp, 125 Volt AC.	Black	SNAP8200USBBK	SNAP8300USBBK
	Brown	SNAP8200USB	SNAP8300USB
	Gray	SNAP8200USBGY	SNAP8300USBGY
	Ivory	SNAP8200USBI	SNAP8300USBI
	Light Almond	SNAP8200USBLA	SNAP8300USBLA
	Red	SNAP8200USBR	SNAP8300USBR
	White	SNAP8200USBW	SNAP8300USBW



15A 125V
NEMA 5-15R
UL CSA
0.5 HP



20A 125V
NEMA 5-20R
UL CSA
1 HP

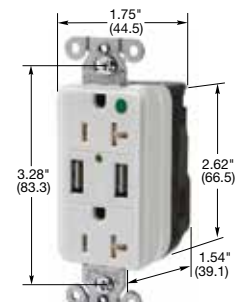

SNAP8300USBW

SNAPConnect® Surge Protection Hospital Grade ●, Tamper-Resistant Receptacle with Power Indicating LED

Description	Color	Catalog Number	
Hospital Grade SNAPConnect Surge suppression, Tamper-Resistant, smooth face, duplex receptacle.	Blue	SNAP8262S	SNAP8362S
	Gray	SNAP8262GYS	SNAP8362GYS
	Ivory	SNAP8262IS	SNAP8362IS
	Light Almond	SNAP8262LAS	SNAP8362LAS
	Red	SNAP8262RS	SNAP8362RS
	White	SNAP8262WS	SNAP8362WS



15A 125V
NEMA 5-15R
UL CSA
0.5 HP



20A 125V
NEMA 5-20R
UL CSA
1 HP

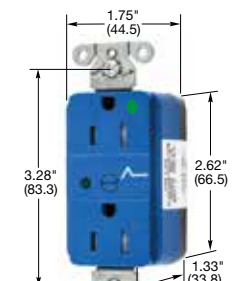

SNAP8262S

SNAPConnect® Right Angle Pigtailed Terminal

Description	Wire Type	General Use	Assembled in USA
Clear right angle terminal with 6 inch leads, 600V, #12 AWG THHN/THWN-2, Polycarbonate housing material.	Solid	SNAP1RA	SNAP1RNA
	Stranded	SNAP2RA	SNAP2RNA

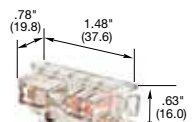

SNAP1RA

Note: See page Tech-10 for Tamper-Resistant and Weather Resistant descriptions.

Dimensions in Inches (mm)

Features and Benefits

Hubbell-PRO Heavy Duty Receptacles

- Automatic self-grounding staple
- Combination Tamper-Resistant and LED for pediatric emergency circuits
- Nylon face and base construction
- Circuit ID marking area
- Back and side wiring
- Tri drive screws
- Steel mounting strap



8200REDLTRA



15A 125V
NEMA 5-15R
UL CSA
0.5 HP



20A 125V
NEMA 5-20R
UL CSA
1 HP



8200LA

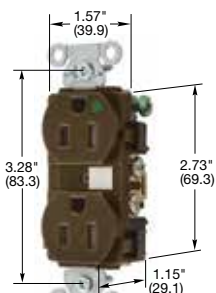

8200TRA

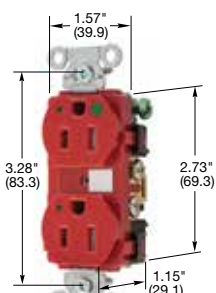

8200REDLTRA

Dimensions in Inches (mm)

Hubbell-PRO Heavy Duty Hospital Grade Receptacles

Duplex

Description	Color	Catalog Number	
Hospital grade, smooth nylon face, back and side wired. Assembled in USA.	Black	8200BK	8300BK
	Brown	8200	8300
	Gray	8200GY	8300GY
	Ivory	8200IV	8300IV
	Light Almond	8200LA	8300LA
	Red	8200RED	8300RED
	White	8200WHI	8300WHI
Hospital grade, Tamper-Resistant, smooth nylon face, back and side wired. Assembled in USA.	Black	8200BKTRA	8300BKTRA
	Brown	8200TRA	8300TRA
	Gray	8200GYTRA	8300GYTRA
	Ivory	8200IVTRA	8300IVTRA
	Light Almond	8200LATRA	8300LATRA
	Red	8200REDTRA	8300REDTRA
	White	8200WTRA	8300WTRA
Hospital grade, with Power Indicating LED, smooth nylon face, back and side wired. Assembled in USA.	Black	8200BKL	8300BKL
	Brown	8200L	8300L
	Gray	8200GYL	8300GYL
	Ivory	8200IVL	8300IVL
	Light Almond	8200LAL	8300LALM
	Red	8200REDL	8300REDL
	White	8200WL	8300WL
Hospital grade, Tamper-Resistant, with Power Indicating LED, smooth nylon face, back and side wired. Assembled in USA.	Black	8200BKLTRA	8300BKLTRA
	Brown	8200LTRA	8300LTRA
	Gray	8200GYLTRA	8300GYLTRA
	Ivory	8200IVLTRA	8300IVLTRA
	Light Almond	8200LALTRA	8300LALTRA
	Red	8200REDLTRA	8300REDLTRA
	White	8200WLTRA	8300WLTRA

Note: See pages A-48 and A-49 for accessories.

See page Tech-10 for Tamper-Resistant and LED Power Indicators description.

See section N for wallplates.

The products listed on this page are Assembled in USA, and many are Buy American Compliant. Please contact Hubbell with any certification requirements.

Features and Benefits

Hubbell-PRO Heavy Duty Receptacles

- Automatic self-grounding staple
- Combination Tamper-Resistant and LED for pediatric emergency circuits
- Nylon face and base construction
- Circuit ID marking area
- Back and side wiring
- Tri drive screws
- Steel mounting strap



2182IVLTRA



15A 125V
NEMA 5-15R
UL CSA
0.5 HP



20A 125V
NEMA 5-20R
UL CSA
1 HP

Hubbell-PRO Heavy Duty Hospital Grade Receptacles

Style Line® Decorator

Description	Color	Catalog Number	
Hospital grade, Style Line® decorator, flush, nylon face, back and side wired. Assembled in USA.	Black	2172BK	2182BK
	Brown	2172	2182
	Gray	2172GY	2182GY
	Ivory	2172IV	2182IV
	Light Almond	2172LA	2182LA
	Red	2172RED	2182RED
	White	2172W	2182W
Hospital grade, Tamper-Resistant, Style Line® decorator, flush, nylon face, back and side wired. Assembled in USA.	Black	2172BKTRA	2182BKTRA
	Brown	2172TRA	2182TRA
	Gray	2172GYTRA	2182GYTRA
	Ivory	2172IVTRA	2182IVTRA
	Light Almond	2172LATRA	2182LATRA
	Red	2172REDTRA	2182REDTRA
	White	2172WTRA	2182WTRA
Hospital grade, with Power Indicating LED, Style Line® decorator, flush, nylon face, back and side wired. Assembled in USA.	Black	2172BKL	2182BKL
	Brown	2172L	2182L
	Gray	2172GYL	2182GYL
	Ivory	2172IVL	2182IVL
	Light Almond	2172LAL	2182LAL
	Red	2172REDL	2182REDL
	White	2172WL	2182WL
Hospital grade, Tamper-Resistant, with Power Indicating LED, Style Line® decorator, flush, nylon face, back and side wired. Assembled in USA.	Black	2172BKLTRA	2182BKLTRA
	Brown	2172LTRA	2182LTRA
	Gray	2172GYLTRA	2182GYLTRA
	Ivory	2172IVLTRA	2182IVLTRA
	Light Almond	2172LALTRA	2182LALTRA
	Red	2172REDLTRA	2182REDLTRA
	White	2172WLTRA	2182WLTRA

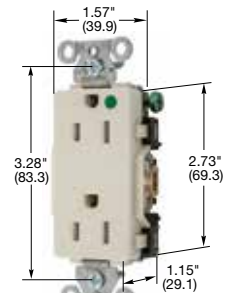

2172LATRA

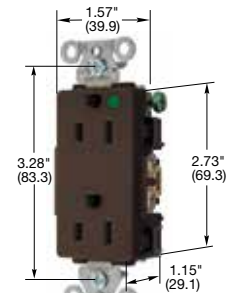

2172L

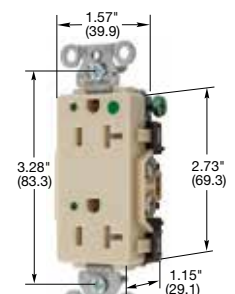

2182IVLTRA

Note: See pages A-48 and A-49 for accessories.
See page Tech-10 for Tamper-Resistant and LED Power Indicators description.
See section N for wallplates.

The products listed on this page are Assembled in USA, and many are Buy American Compliant. Please contact Hubbell with any certification requirements.

Dimensions in Inches (mm)



15A 125V
NEMA 5-15R
UL CSA
0.5 HP



20A 125V
NEMA 5-20R
UL CSA
1 HP

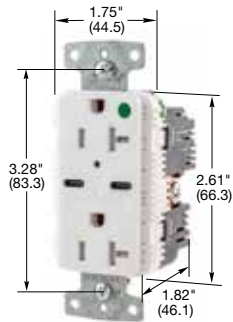

USB8300C5W

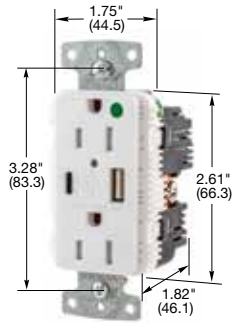

USB8200AC5W

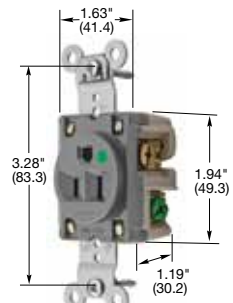

HBL8210GY

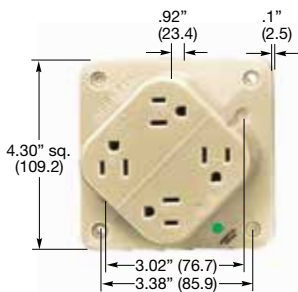

HBL415HI

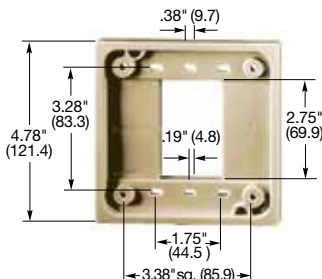

HBL4API

Dimensions in Inches (mm)

Hospital Grade ● USB Charger Type-C, Type A&C and Type A

Description	Color	Catalog Number	Catalog Number
Hospital Grade USB Charger Outlet: two Type-C port configurations, high power 5 Amp, 5 Volt USB output, Tamper-Resistant duplex receptacle, USB ports rated 10,000 cycles.	Black	USB8200C5BK	USB8300C5BK
	Brown	USB8200C5	USB8300C5
	Gray	USB8200C5GY	USB8300C5GY
	Ivory	USB8200C5I	USB8300C5I
	Light Almond	USB8200C5LA	USB8300C5LA
	Red	USB8200C5R	USB8300C5R
	White	USB8200C5W	USB8300C5W
Hospital Grade USB Charger Outlet: one Type A and one Type-C port configurations, high power 5 Amp, 5 Volt USB output, Tamper-Resistant duplex receptacle, USB ports rated 10,000 cycles.	Black	USB8200AC5BK	USB8300AC5BK
	Brown	USB8200AC5	USB8300AC5
	Gray	USB8200AC5GY	USB8300AC5GY
	Ivory	USB8200AC5I	USB8300AC5I
	Light Almond	USB8200AC5LA	USB8300AC5LA
	Red	USB8200AC5R	USB8300AC5R
	White	USB8200AC5W	USB8300AC5W
Hospital Grade USB Charger Outlet: two Type A port configurations, high power 5 Amp, 5 Volt USB output, Tamper-Resistant duplex receptacle, USB ports rated 10,000 cycles.	Black	USB8200A5BK	USB8300A5BK
	Brown	USB8200A5	USB8300A5
	Gray	USB8200A5GY	USB8300A5GY
	Ivory	USB8200A5I	USB8300A5I
	Light Almond	USB8200A5LA	USB8300A5LA
	Red	USB8200A5R	USB8300A5R
	White	USB8200A5W	USB8300A5W

HBL® Extra Heavy Duty Hospital Grade ● Single Receptacles

IP20
SUITABILITY



Description	Color	Catalog Number	Catalog Number
Flush, nylon face, back and side wired, Fed. Spec. verified.	Almond	-	HBL8310AL
	Brown	HBL8210	HBL8310
	Gray	HBL8210GY	HBL8310GY
	Ivory	HBL8210I	HBL8310I
	Red	HBL8210R	HBL8310R
	White	HBL8210W	HBL8310W
Panel mount on 1.94 in. (49.2) centers.	Brown	HBL8284	-
	Ivory	HBL8284I	HBL8384I
Isolated ground ^A .	Orange	IG8210	IG8310

Note: ^ASee section M for additional information on isolated ground devices.

4-PLEX® Hospital Grade ● Receptacles



Description	Color	Catalog Number	Catalog Number
4 outlet high impact resistant Polycarbonate construction. Mount to 4 in. square box.	Brown	HBL415H	HBL420H
	Gray	-	HBL420HGY
	Ivory	HBL415HI	HBL420HI
	Red	HBL415HR	HBL420HR
	White	HBL415HW	HBL420HW

4-PLEX® Accessories

Description	Color	Catalog Number	Catalog Number
4-PLEX adapter plates for 1- and 2-gang, device boxes.	Brown	HBL4AP	HBL4AP
	Gray	HBL4APGY	HBL4APGY
	Ivory	HBL4API	HBL4API
	Red	HBL4APR	HBL4APR
	White	HBL4APW	HBL4APW

Note: See page A-25 for additional information on 4-PLEX devices.

IP20
SUITABILITY



15A 125V
NEMA 5-15P
UL CSA



20A 125V
NEMA 5-20P
UL CSA

Hospital Grade Plugs

Insulgrip®

Description	Cord Diameter	Catalog Number	
Black and white nylon.	.230"-.720" (5.8-18.3)	HBL8215C	HBL8315C
Transparent housing.	.230"-.720" (5.8-18.3)	HBL8215CT	HBL8315CT
8 position angle plug, transparent housing.	.250"-.655" (6.4-16.6)	HBL8215CAT*	HBL8315CAT*

Valise®

Description	Cord Diameter	Catalog Number	
White nylon.	.300"-.660" (7.6-16.8)	HBL8115V	HBL8364V
Insulation displacement, white nylon.	.300"-.360" (7.6-9.1)	HBL8013V*	-

Note: *Not Fed. Spec. Listed.
See page A-49 for accessories

IP20
SUITABILITY



15A 250V
NEMA 6-15P
UL CSA
1.5 HP



20A 250V
NEMA 6-20P
UL CSA
2 HP

Hospital Grade Plugs

Valise®

Description	Cord Diameter	Catalog Number	
Valise plug, white nylon.	.300"-.660" (7.6-16.8)	HBL8666V	HBL8464V

Note: HP ratings listed above are based on 208 to 240V AC only.

IP20
SUITABILITY



15A 125V
NEMA 5-15R
UL CSA
0.5 HP



20A 125V
NEMA 5-20R
UL CSA
1 HP

Hospital Grade Connector Bodies

Insulgrip®

Description	Cord Diameter	Catalog Number	
Black and white nylon.	.230"-.720" (5.8-18.3)	HBL8219C	HBL8319C
Transparent housing.	.230"-.720" (5.8-18.3)	HBL8219CT	HBL8319CT

Valise®

Description	Cord Diameter	Catalog Number	
White nylon.	.300"-.660" (7.6-16.8)	HBL8119V	-

Note: See page A-49 for accessories.

Hospital Grade Connector Bodies

Valise®

Description	Cord Diameter	Catalog Number	
White nylon.	.300"-.660" (7.6-16.8)	-	HBL8469V

HBL® Extra Heavy Duty Hospital Grade Receptacles

Duplex

Description	Color	Catalog Number	
Flush, thermoplastic polyester face, back and side wired, multiple drive screws.	Brown Ivory	HBL8600 HBL8600I	HBL8400 HBL8400I

Note: See page A-48 for accessories.
See section N for wallplates.



HBL8215C

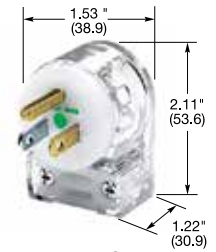

HBL8215CAT

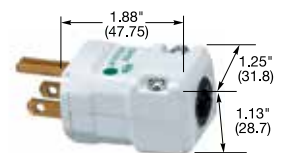

HBL8115V



HBL8219C

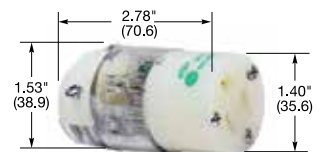

HBL8219CT

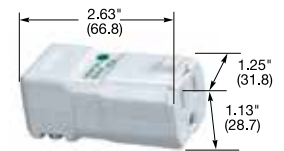

HBL8119V

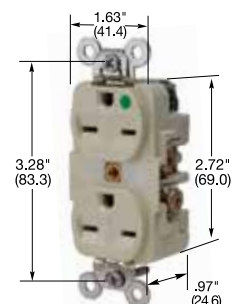

HBL8600I

Dimensions in Inches (mm)

Features and Benefits

Extra Heavy Duty Hospital Grade ● GFCI Receptacles Tamper-Resistant and Weather Resistant

10kA Short Circuit Current Rating

Limits improper access to energized contacts

- Exclusive patented tamper-resistant protection through switching technology
- Continually tests and monitors for people protection automatically
- Patented self test diagnostics

Power indication

- Steady "ON" GREEN LED provides indication of power

Ground fault indicator

- Steady "ON" RED LED provides visual indication of a ground fault condition; flashing red indicates device has lost capability to provide protection

No power at face if reverse wired

- Open circuit condition eliminates false assumption of protection at face

Durable face with V-0 flammability rating

- Polyester face cover



GFR8300SGI





15A 125V
NEMA 5-15R
UL CSA
0.5 HP



20A 125V
NEMA 5-20R
UL CSA
1 HP

AUTOGUARD® Self Test GFCI Receptacles Tamper-Resistant and Weather Resistant

Description	Rating	Color	Catalog Number	
  Flush, polyester face, back and side wired, multiple drive screws.	15 and 20A 125V AC	Black	GFR8200SGBK	GFR8300SGBK
		Brown	GFR8200SG	GFR8300SG
		Gray	GFR8200SGGY	GFR8300SGGY
		Ivory	GFR8200SGI	GFR8300SGI
		Red	GFR8200SGR	GFR8300SGR
		White	GFR8200SGW	GFR8300SGW

Note: GFCI type receptacles should not be used in critical care patient areas or for electrical life support equipment applications because of the possibility of power interruption. All GFCI receptacles listed above are furnished with both a matching color nylon wallplate, and a SS26 302/304 super stainless steel wallplate. 20 amp feed-through capability. See page Tech-10 for Tamper-Resistant and Weather Resistant descriptions.



GFR8300SGW

GFCI Receptacle Specifications per GFCI Products Listed (Pages L-12 to L-15)

Trip Level	4 to 6 mA.
Trip Time	.025 second nominal.
Frequency	60 Hz.
Voltage	120V AC +10% - 15% (102V to 132V).
Amperage	15A/20A, 20A Feed Thru.
Maximum Interrupting Capacity	10,000A.
Operating Temperature	-35°C to 66°C or -30°F to 150°F.
Maximum Humidity	95%.
Listings and Standards	Meets UL498 for receptacles, UL943 Class A for GFCIs UL File E41978. CSA Certified.
Codes	Meets all NEC® and CEC requirements. NEMA WD-6 ANSI 73.

NEC® is a registered trademark of the National Fire Protection Association (NFPA).

Features and Benefits

Commercial Tamper-Resistant GFCI Receptacles

- Patented shutter design for tamper-resistant protection
- Compliant with NEC® 406.12 and NEC® 517-18(c)
- Patented AUTOGUARD® self test technology includes disconnecting power to the receptacle if critical components are damaged and GFCI protection is lost
- Alarm version provides audible notification of a trip condition



GFTRST83B

Hospital Grade ● Tamper-Resistant

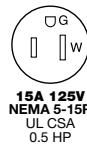

Description	Rating	Color	Catalog Number	Catalog Number		
Night Light Two LED Night Lights, Flush, nylon face, back and side wired, multiple drive screws, self-grounding staple.	15 and 20A 125V AC	Almond	GFTRST82ALNL	GFTRST83ALNL		
		Black	GFTRST82BKNL	GFTRST83BKNL		
		Brown	GFTRST82NL	GFTRST83NL		
		Gray	GFTRST82GYNL	GFTRST83GYNL		
		Ivory	GFTRST82INL	GFTRST83INL		
		Light Almond	GFTRST82LANL	GFTRST83LANL		
		Red	GFTRST82RNL	GFTRST83RNL		
		White	GFTRST82WNL	GFTRST83WNL		
		Alarm, Flush, nylon face, back and side wired, multiple drive screws, self-grounding staple.	15 and 20A 125V AC	Almond	GFTRST82ALB	GFTRST83ALB
				Black	GFTRST82BKB	GFTRST83BKB
Brown	GFTRST82B			GFTRST83B		
Gray	GFTRST82GYB			GFTRST83GYB		
Ivory	GFTRST82IB			GFTRST83IB		
Light Almond	GFTRST82LAB			GFTRST83LAB		
Red	GFTRST82RB			GFTRST83RB		
White	GFTRST82WB			GFTRST83WB		



GFTRST83WNL



GFTRST83GYB

Product Dimensions Inches (mm)

GFCI Receptacle	
A	3.27 (83.1)
B	2.75 (69.8)
C	1.75 (44.5)
D	1.47 (37.4)
E	1.10 (27.9)

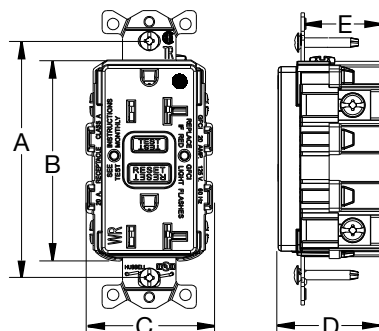

Dimensions in Inches (mm)

Features and Benefits

Commercial Tamper and Weather Resistant GFCI Receptacles

- Patented shutter design for tamper-resistant protection
- Meets NEC® requirements for TR (517-18c) and WR (406.9), UV and corrosion resistance for harsh and damp applications
- Patented AUTOGUARD® self test technology
- Protects against line and load reversal, no power to the face or downstream if device is miswired



GFTWRST83WIG



Hospital Grade • Tamper-Resistant Weather Resistant



15A 125V
NEMA 5-15R
UL CSA
0.5 HP



20A 125V
NEMA 5-20R
UL CSA
1 HP



GFTWRST82AL



GFTWRST83GYU



GFTWRST82BKIG



GFTWRST83SNAPI



SNAP1RA

Description	Rating	Color	Catalog Number	Catalog Number
Standard, Flush, nylon face, back and side wired, multiple drive screws, self-grounding staple.	15 and 20A 125V AC	Almond	GFTWRST82AL	GFTWRST83AL
		Black	GFTWRST82BK	GFTWRST83BK
		Brown	GFTWRST82	GFTWRST83
		Gray	GFTWRST82GY	GFTWRST83GY
		Ivory	GFTWRST82I	GFTWRST83I
		Light Almond	GFTWRST82LA	GFTWRST83LA
		Red	GFTWRST82R	GFTWRST83R
White	GFTWRST82W	GFTWRST83W		
Assembled in USA, Flush, nylon face, back and side wired, multiple drive screws, self-grounding staple.	15 and 20A 125V AC	Almond	GFTWRST82ALU	GFTWRST83ALU
		Black	GFTWRST82BKU	GFTWRST83BKU
		Brown	GFTWRST82U	GFTWRST83U
		Gray	GFTWRST82GYU	GFTWRST83GYU
		Ivory	GFTWRST82IU	GFTWRST83IU
		Light Almond	GFTWRST82LAU	GFTWRST83LAU
		Red	GFTWRST82RU	GFTWRST83RU
White	GFTWRST82WU	GFTWRST83WU		
Isolated Ground, Flush, nylon face, back and side wired, multiple drive screws, self-grounding staple.	15 and 20A 125V AC	Almond	GFTWRST82ALIG	GFTWRST83ALIG
		Black	GFTWRST82BKIG	GFTWRST83BKIG
		Brown	GFTWRST82IG	GFTWRST83IG
		Gray	GFTWRST82GYIG	GFTWRST83GYIG
		Ivory	GFTWRST82IIG	GFTWRST83IIG
		Light Almond	GFTWRST82LAIG	GFTWRST83LAIG
		Red	GFTWRST82RIG	GFTWRST83RIG
White	GFTWRST82WIG	GFTWRST83WIG		
SNAPConnect®, Flush, nylon face, back and side wired, multiple drive screws, self-grounding staple.	15 and 20A 125V AC	Almond	GFTWRST82SNAPAL	GFTWRST83SNAPAL
		Black	GFTWRST82SNAPBK	GFTWRST83SNAPBK
		Brown	GFTWRST82SNAP	GFTWRST83SNAP
		Gray	GFTWRST82SNAPGY	GFTWRST83SNAPGY
		Ivory	GFTWRST82SNAPI	GFTWRST83SNAPI
		Light Almond	GFTWRST82SNAPLA	GFTWRST83SNAPLA
		Red	GFTWRST82SNAPR	GFTWRST83SNAPR
White	GFTWRST82SNAPW	GFTWRST83SNAPW		

SNAPConnect® Right Angle Pigtailed Terminal

Description	Wire Type	General Use Catalog Number	Assembled in USA Catalog Number
Clear right angle terminal with 6 inch leads #12 AWG THHN/THWN-2; Polycarbonate housing material.	Solid	SNAP1RA	SNAP1RNA
	Stranded	SNAP2RA	SNAP2RNA

Features and Benefits

Commercial Standard Hospital Grade • GFCI Receptacles

- Fed. Spec UL Listed, Hospital Grade
- Green power indicator and red trip indicator
- Patented AUTOGUARD® self test technology
- Flush, nylon face, back and side wired, multiple drive screws, self-grounding staple



15A 125V
NEMA 5-15R
UL CSA
0.5 HP



20A 125V
NEMA 5-20R
UL CSA
1 HP

Hospital Grade • GFCI Receptacles

Rating	Rating	Color	Catalog Number			
Standard, Flush, nylon face, back and side wired, multiple drive screws, self-grounding staple.	15 and 20A 125V AC	Almond	GFRST82AL	GFRST83AL		
		Black	GFRST82BK	GFRST83BK		
		Brown	GFRST82	GFRST83		
		Gray	GFRST82GY	GFRST83GY		
		Ivory	GFRST82I	GFRST83I		
		Light Almond	GFRST82LA	GFRST83LA		
		Red	GFRST82R	GFRST83R		
		White	GFRST82W	GFRST83W		
		Assembled in USA, Flush, nylon face, back and side wired, multiple drive screws, self-grounding staple.	15 and 20A 125V AC	Almond	GFRST82ALU	GFRST83ALU
				Black	GFRST82BKU	GFRST83BKU
Brown	GFRST82U			GFRST83U		
Gray	GFRST82GYU			GFRST83GYU		
Ivory	GFRST82IU			GFRST83IU		
Light Almond	GFRST82LAU			GFRST83LAU		
Red	GFRST82RU			GFRST83RU		
White	GFRST82WU			GFRST83WU		
Night Light Two LED Night Lights, Flush, nylon face, back and side wired, multiple drive screws, self-grounding staple.	15 and 20A 125V AC			Almond	GFRST82ALNL	GFRST83ALNL
				Black	GFRST82BKNL	GFRST83BKNL
		Brown	GFRST82NL	GFRST83NL		
		Gray	GFRST82GYNL	GFRST83GYNL		
		Ivory	GFRST82INL	GFRST83INL		
		Light Almond	GFRST82LANL	GFRST83LANL		
		Red	GFRST82RNL	GFRST83RNL		
		White	GFRST82WNL	GFRST83WNL		
		Alarm, Flush, nylon face, back and side wired, multiple drive screws, self-grounding staple.	15 and 20A 125V AC	Almond	GFRST82ALB	GFRST83ALB
				Black	GFRST82BKB	GFRST83BKB
Brown	GFRST82B			GFRST83B		
Gray	GFRST82GYB			GFRST83GYB		
Ivory	GFRST82IB			GFRST83IB		
Light Almond	GFRST82LAB			GFRST83LAB		
Red	GFRST82RB			GFRST83RB		
White	GFRST82WB			GFRST83WB		
SNAPConnect®, Flush, nylon face, back and side wired, multiple drive screws, self-grounding staple.	15 and 20A 125V AC			Almond	GFRST82SNAPAL	GFRST83SNAPAL
				Black	GFRST82SNAPBK	GFRST83SNAPBK
		Brown	GFRST82SNAP	GFRST83SNAP		
		Gray	GFRST82SNAPGY	GFRST83SNAPGY		
		Ivory	GFRST82SNAPI	GFRST83SNAPI		
		Light Almond	GFRST82SNAPLA	GFRST83SNAPLA		
		Red	GFRST82SNAPR	GFRST83SNAPR		
		White	GFRST82SNAPW	GFRST83SNAPW		



GFRST82WNL



GFRST82R



GFRST83INL



GFRST83BKB



GFRST83SNAPGY

SNAPConnect® Right Angle Pigtailed Terminal

Description	Wire Type	General Use Catalog Number	Assembled in USA Catalog Number
Clear right angle terminal with 6 inch leads #12 AWG THHN/THWN-2; Polycarbonate housing material.	Solid Stranded	SNAP1RA SNAP2RA	SNAP1RNA SNAP2RNA



Surge Protection Devices





15A 125V
NEMA 5-15R
UL CSA
0.5 HP



20A 125V
NEMA 5-20R
UL CSA
1 HP

Hospital Grade • Circuit Guard® Receptacles

Description	Color	Catalog Number	
  SNAPConnect® Tamper-Resistant, surge suppression receptacle, smooth face, duplex. Requires connector on page L-15, sold separately.	Blue	SNAP8262S	SNAP8362S
	Gray	SNAP8262GYS	SNAP8362GYS
	Ivory	SNAP8262IS	SNAP8362IS
	Light Almond	SNAP8262LAS	SNAP8362LAS
	Red	SNAP8262RS	SNAP8362RS
	White	SNAP8262WS	SNAP8362WS
Surge suppression receptacles with light and alarm, 240 joules/15000A per mode.	Almond	HBL8262ALSA	HBL8362ALSA
	Blue	HBL8262SA	HBL8362SA
	Gray	HBL8262GYSA	HBL8362GYSA
	Ivory	HBL8262ISA	HBL8362ISA
	Red	HBL8262RSA	HBL8362RSA
	White	HBL8262WSA	HBL8362WSA
Isolated ground, surge suppression receptacles with light and alarm, 240 joules/15000A per mode.	Blue	IG8262SA	IG8362SA
	Gray	IG8262GYSA	IG8362GYSA
	Ivory	IG8262ISA	IG8362ISA
	Orange	IG8262OSA	IG8362OSA
	Red	IG8262RSA	IG8362RSA
	White	IG8262WSA	IG8362WSA
4-PLEX® surge suppression receptacles with lights, 80 joules/6500A per mode.	Blue	-	HBL420HS
	Ivory	-	HBL420HIS
	Red	-	HBL420HRS

Note: See page Tech-10 for Tamper-Resistant and LED Power Indicators descriptions.

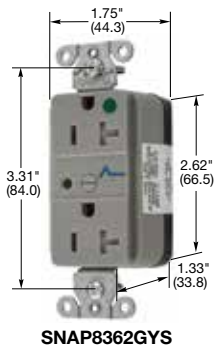

SNAP8362GYS

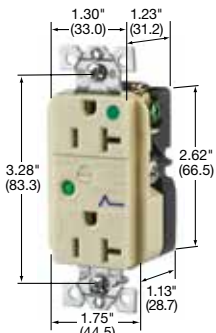

HBL8362ISA

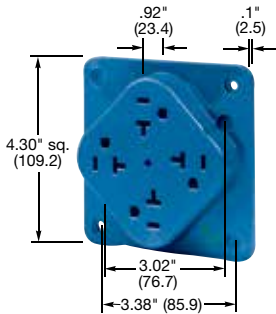

HBL420HS

4-PLEX® Accessories

Description	Color	Catalog Number
4-PLEX Adapter Plates for 1- and 2-gang, and 4 in. (101.6) square device boxes.	Blue	HBL4APBL
	Ivory	HBL4API
	Red	HBL4APR
4-PLEX Portable Box. Portable 4 in. (101.6) square box with cord grip. Accepts up to .66 in. (16.8) diameter cord.	Ivory	HBL4PBI

Note: 4-PLEX Box is not UL Listed.

UL2930 Listed



UL2930 Health Care Outlet Assembly (HCOA)

Description	# of Outlets	Cord Length	Color	15 Amp	20 Amp
UL 2930 HCOA with L-N Surge Protection	6	6'	White	HBL6MG6	HBL6MG620
	6	15'	White	HBL6MG15	HBL6MG1520
UL 2930 HCOA Relocatable Power Tap (RPT)	6	6'	White	HBL6MGRPT6	HBL6MGRPT620
	6	15'	White	HBL6MGRPT15	HBL6MGRPT1520



HBL6MGRPT620

Listed to UL1449



SpikeShield® Surge Protective Devices (SPD) with Tamper-Resistant Receptacles and Heavy Duty Plug

Description	# of Outlets	Cord Length	Color	15 Amp	20 Amp
Type 3 SPD, Heavy Duty Metal Housing	6	6'	White	HBL6HG6	HBL6HG620
	6	15'	White	HBL6HG15	HBL6HG1520
UL Type 3 SPD, Heavy Duty Metal Housing with 2-port USB	4	6'	White	HBL6HGUSB6	-



HBL6HGUSB6

Dimensions in Inches (mm)



Hubbellok® Plugs, Connector Bodies and Receptacles

For Hospital Use Only



Hubbellok® Plugs and Connector Bodies

Description	Plugs	Connector Bodies
Nylon cover, thermoset interior.	HBL23014HGB	HBL23001HGB
Armored, epoxy filled, rubber cord grip.	HBL23004HG	-

Note: Cord clamp range for plug and connector .300" to .660" (7.6 to 16.8).



20A 125V AC



20A 125V AC



HBL23014HGB

Receptacles

Description	Catalog Number
Black, back wired.	- HBL23000HG



HBL23001HGB

Wallplates

Description	Catalog Number
Stainless steel 302/304, single-gang.	HBL23901HG
Stainless steel 302/304, three-gang for two receptacles.	HBL23909HG

Note: Suffix HG or HGB type for hospital use only.



IP30
SUITABILITY

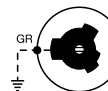

20A 125V AC

Explosion Proof Plug

Description	Catalog Number
Plug, with, epoxy kit, accepts #12 or #14 type SO cable.	HBL24312

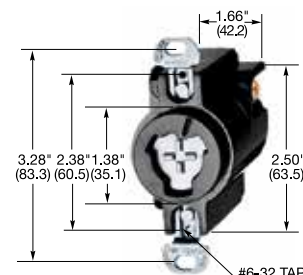

HBL23000HG

Hazardous to Non-hazardous Location Receptacle Conversion Kits

Conversion kits for replacement of explosion proof receptacles listed above, with non-explosion proof receptacles, in the hospital areas formerly classified as hazardous locations and now classified non-hazardous locations due to the change from flammable anesthetizing gases to nonflammable anesthetizing gases.

For Conversion To:	Catalog Number
20A, 125V, duplex receptacle (Hubbell HBL830 Series). Includes adapter ring and stainless steel wall plate for duplex receptacle (receptacle not included).	HBL24300RKD
20A, 125V, Hospital Hubbellok receptacle (Hubbell HBL23000HG) or 20A, 125V, straight blade single receptacle (Hubbell HBL8310 series). Includes adapter ring and stainless wall plate for single receptacle (receptacle not included).	HBL24300RKS

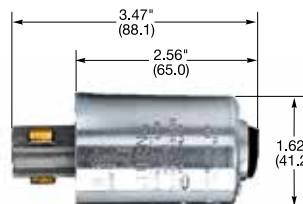

HBL24312

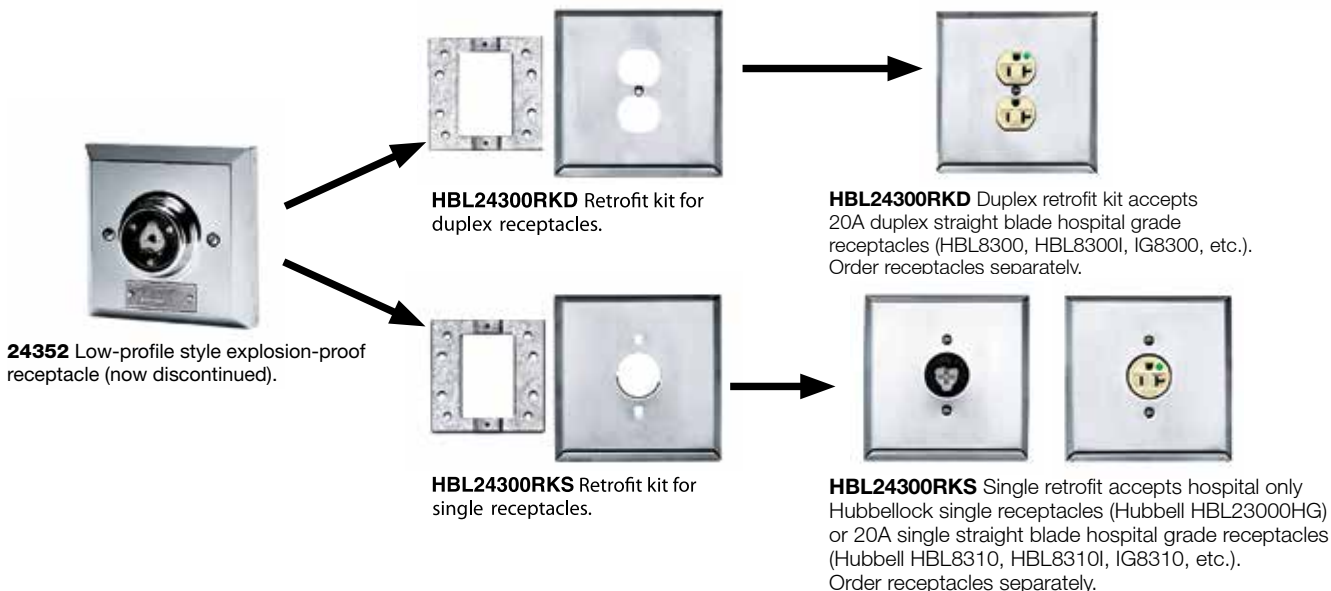

Dimensions in Inches (mm)



Hubbellock® Mobile X-Ray Devices



HBL25515



HBL25615

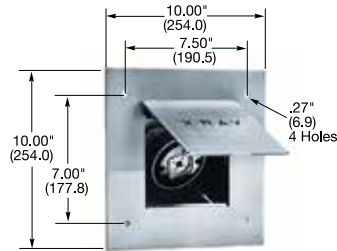

HBL25605

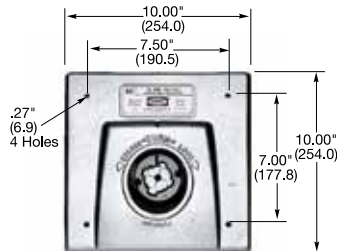

HBL25603

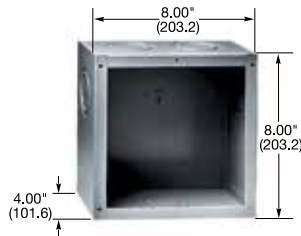

HBL25509

IP30
SUITABILITY

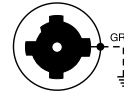

50A 250V AC

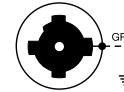

60A 250V AC

Mobile X-Ray Plugs

Description	Catalog Number	
Plug, with epoxy kit, less cord clamp.	HBL25515	HBL25615
Plug, with cord clamp, less epoxy kit.	HBL25525	HBL25625

Note: Cord clamp range of plugs with cord clamps .830" to 1.3" (21.1 to 33.0).
50A plugs fit 50A or 60A receptacles.

Mobile X-Ray Receptacles

Description	Catalog Number	
Receptacle with stainless steel plate assembly.	HBL25505	HBL25605
Receptacle with cast aluminum plate assembly.	HBL25503	HBL25603
Replacement receptacle interior.	-	IN16494

Accessory

Description	Catalog Number
Box stamped steel 8" x 8" x 4" (203.2 x 203.2 x 101.6), accommodates 50A and 60A mobile X-ray receptacles. Knockout sizes 1¼", 1½" and 2".	HBL25509

Dimensions in Inches (mm)