

Project		Catalog #		Type	
Prepared by		Notes		Date	



HALO

LT56 Selectable CCT – Baffle

5”/6” All-Purpose LED Retrofit Module
600 Lumen Series

Typical Applications

Residential

Interactive Menu

- Order Information page 2
- Product Specifications page 3
- Energy Data page 3
- Photometric Data page 4
- Product Warranty

Product Certification



Refer to ENERGY STAR® Certified Products List.
Can be used to comply with California Title 24 High Efficacy requirements.
Certified to California Appliance Efficiency Database under J48.

Product Features



Top Product Features

- Selectable CCT: 2700K, 3000K, 3500K or 3000K, 4000K, 5000K
- Baffle trim
- Dimmable down to 10%
- Retrofits into existing 5” or 6” housings
- Use with Halo 5” or 6” LED housings - new construction and remodel
- Wet location listed and “dead front”

Dimensional and Mounting Details

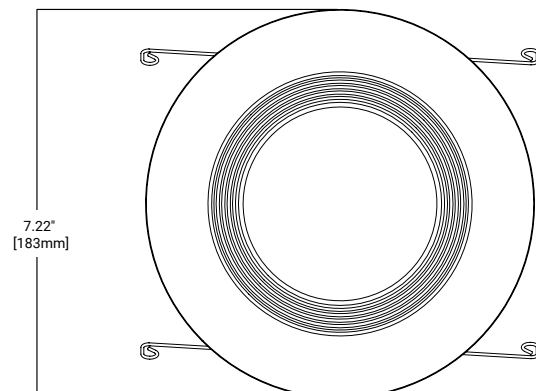
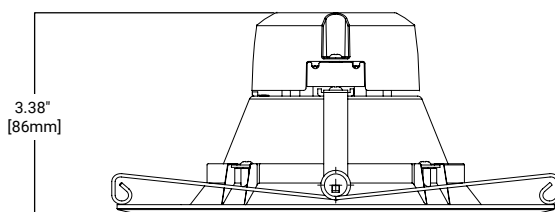

Order Information

SAMPLE ORDER NUMBER: **LT56069FS351EWHR**

A complete luminaire consists of a housing and a LED integrated trim, order separately.

Module	Lumens	CRI/CCT	Driver	Finish	Packaging
LT56 = 5/6-inch LED retrofit module, baffle trim	06 = 600 lumens (nominal)	9FS23 = 90 CRI min, 2700K, 3000K, 3500K selectable CCT 9FS35 = 90 CRI min, 3000K, 4000K, 5000K selectable CCT	1E = 120V 60Hz, LE & TE phase cut 10% dimming	WH = Matte White flange	R = Recyclable 4-color unit carton

Accessories

Accessories

HE26LED = Replacement medium base (E26) screw base adapter (one included with unit)

Housings

Housings

Halo LED 5-inch

H550ICAT = 5" LED, Insulated Ceiling, Air-Tite, New Construction Housing
H550RICAT = 5" LED, Insulated Ceiling, Air-Tite, Remodel Housing
E550ICAT = 5" LED, Insulated Ceiling, Air-Tite, New Construction Housing
E550RICAT = 5" LED, Insulated Ceiling, Air-Tite, Remodel Housing
H550FR2ICATD010 = 6" IC, airtight, 2 hour fire rated, new construction housing, LED, 120 - 277V

Halo LED 6-inch

H750ICAT = 6" LED, Insulated Ceiling, Air-Tite, New Construction Housing
H750RICAT = 6" LED, Insulated Ceiling, Air-Tite, Remodel Housing
H750T = 6" LED, Non-IC, Air-Tite, New Construction Housing
H750TCP = 6" LED, Non-IC, New Construction/Remodel Chicago Plenum Housing
H2750ICAT = 6" LED, Shallow, Insulated Ceiling, Air-Tite, New Construction (use with 691X, 694X, 696X trims only)
H2750RICAT = 6" LED, Shallow, Insulated Ceiling, Air-Tite, Remodel (use with 691X, 694X, 696X trims only)
E750ICAT = 6" LED, Insulated Ceiling, Air-Tite, New Construction Housing
E750RICAT = 6" LED, Insulated Ceiling, Air-Tite, Remodel Housing
H750FR2ICAT = 6" IC, airtight, 2 hour fire rated, new construction housing, LED, 120 - 277V

Halo LED retrofit

ML7E26RFK = 6" Retrofit Enclosure, Non-IC, E26 Screw base Interface
ML7BXFK = 6" Retrofit Enclosure, Non-IC, BX Whip

Halo Shallow Housings 5-inch

H25ICAT = 5" Shallow, Insulated Ceiling, Air-Tite New Construction
H25RICAT = 5" Shallow, Insulated Ceiling, Air-Tite Remodel
H25ICATNB = 5" Shallow, Insulated Ceiling, Air-Tite New Construction, No Socket Bracket

Halo Shallow Housings 6-inch

H27ICAT = 6" Shallow, Insulated Ceiling, Air-Tite New Construction
H27RICAT = 6" Shallow, Insulated Ceiling, Air-Tite Remodel Housing
H27T = 6" Shallow, Non-IC, New Construction Housing
H27RT = 6" Shallow, Non-IC, Remodel Housing
E27ICAT = 6" Shallow, Insulated Ceiling, Air-Tite New Construction
E27RICAT = 6" Shallow, Insulated Ceiling, Air-Tite Remodel Housing
E27TAT = 6" Shallow, Non-IC, New Construction Housing
E27RTAT = 6" Shallow, Non-IC, Remodel Housing

Halo Standard Housings 5-inch

H5ICAT = 5" Insulated Ceiling, Air-Tite New Construction Housing
H5RICAT = 5" Insulated Ceiling, Air-Tite Remodel Housing
H5ICATNB = 5" Insulated Ceiling, Air-Tite New Construction Housing, No Socket Bracket
H5T = 5" Non-IC, New Construction Housing
H5RT = 5" Non-IC, Remodel Housing
H5TNB = 5" Non-IC, New Construction Housing, No Socket Bracket
ESICAT = 5" Insulated Ceiling, Air-Tite New Construction Housing
ESRICAT = 5" Insulated Ceiling, Air-Tite Remodel Housing
ESICATNB = 5" Insulated Ceiling, Air-Tite New Construction Housing, No Socket Bracket
ESTAT = 5" Non-IC, New Construction Housing
ESTATNB = 5" Non-IC, Remodel Housing
ESTATNB = 5" Non-IC, New Construction Housing, No Socket Bracket

Halo Standard Housings 6-inch

H7ICAT = 6" Insulated Ceiling, Air-Tite New Construction Housing
H7RICAT = 6" Insulated Ceiling, Air-Tite Remodel Housing
H7ICT = 6" Insulated Ceiling, New Construction Housing
H7RICT = 6" Insulated Ceiling, Remodel Housing
H7ICATNB = 6" Insulated Ceiling, Air-Tite New Construction Housing, No Socket Bracket
H7ICTNB = 6" Insulated Ceiling, New Construction Housing, No Socket Bracket
H7T = 6" Non-IC, New Construction Housing
H7RT = 6" Non-IC, Remodel Housing
H7TNB = 6" Non-IC, New Construction Housing, No Socket Bracket
H7TCP = 6" Non-IC, Chicago Plenum, New Construction/Remodel Housing
H7UICAT = 6" Insulated Ceiling, Universal, Air-Tite, New Construction Housing
E7ICAT = 6" Insulated Ceiling, Air-Tite New Construction Housing
E7RICAT = 6" Insulated Ceiling, Air-Tite Remodel Housing
E7ICATNB = 6" Insulated Ceiling, Air-Tite New Construction Housing, No Socket Bracket
E7TAT = 6" Non-IC, New Construction Housing
E7RTAT = 6" Non-IC, Remodel Housing
E7TATNB = 6" Non-IC, New Construction Housing, No Socket Bracket

Notes

LT56 Series LED Retrofit is UL Classified for retrofit in the following 5/6" recessed housings:

The LT Series LED light module - trim combination is cULus Listed or UL Classified for use with any 5"/6" diameter recessed housing constructed of steel or aluminum with an internal volume that exceeds 107.9 in3 in addition to those noted above.

Specification Features

Module

- LED module consists of LED array, optical assembly, driver and self-flanged trim
- Baffle style trim
- Achieving L70 at 35,000 hours in IC and non-IC applications

Gaskets

- Closed cell gasket achieves restrictive airflow requirements without additional caulking

LED Array

- A plurality of low power LEDs provide a uniform source with high efficiency and long life
- Available in 90 CRI minimum, R9 greater than 50 and color accuracy within 4 SDCM provide color accuracy and uniformity
- Available in 3-color selectable CCT: choose 2700K, 3000K, 3500K or 3000K, 4000K, 5000K

Optical Assembly

- Optical assembly provides wide distribution useful for general and task lighting
- Diffuse injection molded lens with contoured profile provides uniformity and a familiar lamp like appearance
- Meets ENERGY STAR® color angular uniformity requirements

Driver

- Integral 120V 60 Hz constant current driver provides high efficiency operation
- Continuous, flicker-free dimming from 100% to 10% with select leading or trailing edge 120V phase cut dimmers – consult dimming guide for more information
- Consult dimmer manufacturer for compatibility and conditions of use
- Inline electrical quick connect and E26 adapter (provided) provides mains connection
- A separate ground wire and mounting hardware insures proper ground connection to housing

Retention

- Torsion springs are pre-installed and adjust to fit 5" and 6" compatible housings

Trim

- One-piece smooth splay or step baffle and self-flanged trim ring provides lens regression and reduces light leaks
- Injection molded plastic construction is impact resistant and non-corrosive
- Non-conductive construction meets most local code 'dead front' requirements

Compliance

- UL Certified for US and Canada for use with Halo housings, classified for use with other's housings, see instruction sheet for conditions of acceptability
- Wet location listed
- Air-tite per ASTM-E283
- Suitable for use in clothes closets when installed in accordance with the NEC 410.16 spacing requirements
- EMI/RFI emissions per FCC 47CFR Part 15 consumer limits
- Contains no mercury or lead and RoHS compliant
- Photometric testing in accordance with IES LM79-08
- Lumen maintenance projections in accordance with IES LM-80-08 and TM-21-11
- Can be used for State of California Title 24 high efficacy luminaire compliance, reference the California Energy Commission Title 20 Appliance Efficiency Database for current listings
- ENERGY STAR® listed, reference database for current listings
- Meets State of California voluntary lamp standards

Warranty

- Five year limited warranty, consult website for details. www.cooperlighting.com/legal

Energy Data

Energy Data	
Lumens	600 Series
Input Voltage	120V
Input Current	0.06 (A)
Input Power	6.97 (W)
Efficiency	Up to 88 (LPW)
Inrush	2 (A)
THD: ≤ 17.2%	
PF: ≥ 0.960	
T Ambient -30 - +40°C	
Sound Rating ≤ 23dba	

Photometric Data

 View IES files

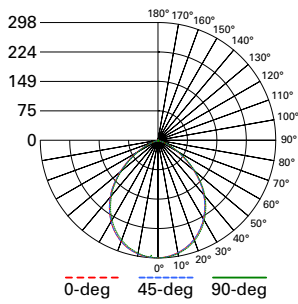

LT56069FS231EWHR - 2700K
 Spacing criterion: (0-180) 1.18
 (90-270) 1.18
 (Diagonal) 1.25
 Beam Angle: 92°
 Lumens: 623
 Input Watts: 6.75 W
 Efficacy: 92.2 LPW
 UGR: 17
 Test Report:
 LT56069FS231EWHR.ies

Zonal Lumen	Lumens	% Lumens
0-30	225	36.1
0-40	356	57.3
0-60	560	90
0-90	619	99.4

TM-30-15	Rf = 92
	Rg = 99
CRI/CIE	Ra = 94
	R9 = 61

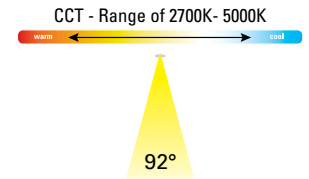

LT56 3CCT Baffle - 2700K / 3000K / 3500K				
CCT	Watts	lumens	LPW	CRI
2700K	7.1	615	86.6	92
3000K	6.8	670	98.5	92
3500K	7.2	660	91.7	91

LT56069FS231EWHR - 3000K

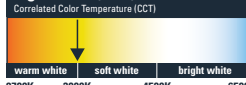
PRODUCT SPECIFICATIONS	
Lumens	670
Watts	6.8
Lumens Per Watt (Efficacy)	98.5
Color Accuracy (CRI)	92
Light Color (CCT)	3000K
Correlated Color Temperature (CCT)	
	
warm white soft white bright white 2700K 3000K 4500K 6500K	

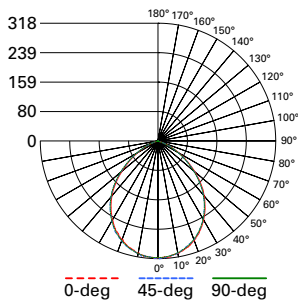

LT56069FS351EWHR - 3000K
 Spacing criterion: (0-180) 1.18
 (90-270) 1.18
 (Diagonal) 1.25
 Beam Angle: 92°
 Lumens: 662
 Input Watts: 6.89 W
 Efficacy: 96.1 LPW
 UGR: 17
 Test Report:
 LT56069FS351EWHR.ies

Zonal Lumen	Lumens	% Lumens
0-30	237	35.8
0-40	377	56.9
0-60	594	89.7
0-90	658	99.4

TM-30-15	Rf = 92
	Rg = 99
CRI/CIE	Ra = 94
	R9 = 63

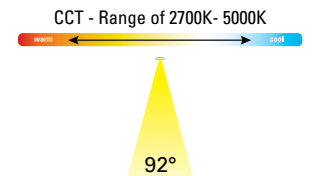

LT56 3CCT Baffle - 3000K / 4000K / 5000K				
CCT	Watts	lumens	LPW	CRI
3000K	7.1	645	90.8	92
4000K	6.8	690	101.5	93
5000K	7.2	665	92.4	93

LT56069FS351EWHR - 3000K

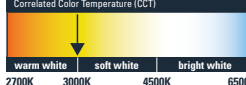
PRODUCT SPECIFICATIONS	
Lumens	645
Watts	7.1
Lumens Per Watt (Efficacy)	90.8
Color Accuracy (CRI)	92
Light Color (CCT)	3000K
Correlated Color Temperature (CCT)	
	
warm white soft white bright white 2700K 3000K 4500K 6500K	